



Bu katalogtaki tüm telif hakkı Albatır Endüstri A.Ş. aittir. Yazılı izin olmadan tam yada kısmen kopyalanamaz veya çoğaltılamaz. Tüm detaylarda ve teknik konularda deęişiklik yapma hakkı saklıdır. Ürünlerimiz faydalı model ve endüstriyel tasarım belgeleri ile tescillenmiştir.

All rights in this catalog reserved by Albatır Endüstri A.Ş. no part of this publication may be reproduced or copied without any written permission. All technical details are subject to change. Our products are registered with utility model and industrial design documentations.

Katalogtaki ürün sayfalarında verilen teknik ölçüler bağlayıcı değildir. Önerilen kurulum ölçüleridir. Albatır ürün özelliklerinde haber vermeden deęişiklik yapabilir.

Technical dimensions are not binding given in the catalog. They are recommended installation sizes. Albatır can make modification on the products features without any notice.

Tipografik hatalardan firmamız sorumlu değildir.
Our company is not responsible for typographic fault.

ALBATUR[®]
produces quality



Hakkımızda

ABOUT US



Hakkımızda

Türkiye'nin önde gelen sürgü sistem markası Albatür Endüstri A.Ş.'nin yolculuğu 1976 yılında Bursa'da başlamıştır.

Üretici kimliği ile farklı sektörlerle hizmet eden firmamız, 2003 yılından bu yana odak noktasını sürgülü katlanır kapı ve kapak sistemleri olarak belirlemiştir.

45 yıllık üretim deneyimine sahip Albatür, ürünlerini Bursa'nın Nilüfer ilçesinde 11.000 m² fabrikasında doğaya saygılı modern tesislerinde üretmektedir.

Üretimi gerçekleştirilen tüm mobilya donanımlarının; ar-ge, tasarım, kalıp, sac şekillendirme, eksantrik pres, hidrolik pres, plastik enjeksiyon, cnc talaşlı imalat, elektrostatik fırın boya, yağ boya, alüminyum işleme makinaları, montaj ve robot otomasyonları kendi bünyesinde bulunmaktadır. Üretim süreçlerimiz alanında uzman mühendislerimizin kontrolünde gerçekleşmektedir.

Albatür, geliştirdiği ürünlerle yaşam alanlarını büyütmenin yanı sıra, yenilikçi ve teknolojik çözümlerle en üst seviyede müşteri memnuniyetini hedef olarak belirleyen sektörüne değer katan bir markadır.

İç pazarda 300+ aktif iş ortağı ve yurtdışında 5 kıtada sayısı her gün artan 80+ ülkeye gerçekleştirdiği ihracatıyla Albatür, Türkiye ve dünyada mobilya aksesuarlarında hayata değer katan çözümler sunar.

Bu yolculukta bizlerle beraber olan değerli iş ortaklarımıza, paydaşlarımıza, çalışanlarımıza, ürünlerimizi tercih eden müşterilerimize ve bizleri destekleyen herkese gönülden teşekkür ediyoruz.

About Us

In Turkey's leading Sliding System Company Albatür Industry Inc's journey was started in Bursa at 1976

Our Company, which serves different sectors with its own identity, since 2003 has determined its focus on sliding folding systems and sliding door systems.

With 45 years of production experience Albatür is manufacturing its products in Bursa's Nilüfer district 11.000 m² factory in modern facility and respected to nature.

All furniture fittings manufactured; R&D, design, mold, sheet metal forming, eccentric press, hydraulic press, plastic injection, cnc machining, electrostatic painting, wet painting, aluminum processing machines, assembly and robot automations has own in-house manufacture. Our production processes are under the control of our engineers who are experts in their fields.

Albatür, besides expanding living spaces with products it has developed, is a brand that sets the highest level of customer satisfaction as a target with innovative and technological solutions and adds value to its sector.

Albatür provides solutions adding the value to life in furniture accessories in Turkey and around the World; today with 300+ active business partners in the domestic market and exports to more than 80+ countries the number of which is increasing day by day in 5 continents.

We sincerely thank to our valuable business partners, stakeholders, employees, customers and who prefer our products, supports and who have been with us on this journey.

Çevre Politikamız

ENVIRONMENTAL POLICY



Albatur Endüstri A.Ş., yürüttüğü tüm faaliyetlerde çevrenin korunmasını, sürekli iyileştirmeyi, doğal kaynakların etkin kullanılmasını, yasalara tam uyum ve kirliliğin önlenmesini, faaliyetleri sırasında oluşan atıkların öncelikli olarak kaynağında azaltılmasını ve ayrıştırılmasını, geri dönüşüme kazandırılmasını, en uygun yöntemlerle bertaraf edilmesini çevre politikasının temeli kabul eder.

Bu politika çerçevesinde ;

- Faaliyetlerimizin çevresel boyutlarını belirlemeyi, etkilerinin türlerini ve zararlarını tespit ederek çevresel etkileri en aza indirmek için en iyi yöntem ve teknolojileri kullanmayı,
- Çalışanlarımızı, tedarikçilerimizi ve taşeronlarımızı çevrenin korunması konusunda bilinçlendirmek amacıyla eğitim faaliyetleri düzenlemeyi,
- Mümkün olduğu kadar yenilenebilir enerji kaynaklarını seçip, doğal kaynakları verimli kullanmayı,
- Çevresel kirliliği önlemek amacıyla, yasal, uluslararası mevzuatları takip etmeyi ve bunlara uyum sağlayarak çevre performansını sürekli iyileştirmeyi görev edinmiştir.

Gelecek nesillere yaşanılabilir bir dünya bırakmanın sorumluluk olduğu düşüncesiyle, Albatur olarak üretimde kullandığımız elektriği güneş enerjisinden elde ediyoruz.

Albatur Industry Inc. adopts the environmental policy in all activities it carries out, continuous improvement, effective use of natural resources, full compliance with the law and prevention of pollution, reduction and separation of the wastes generated during its operations at the source, recycling and recycling with the most appropriate methods.

Within of this policy;

- Using the best methods and technologies to minimize environmental impacts by identifying environmental aspects of our operations, identifying the types and harms of impacts,
- To organize training activities to raise awareness of our employees, suppliers and subcontractors on environmental protection,
- Selecting as much renewable energy resources as possible,
- In order to prevent environmental pollution, it has the duty to follow the legal, international regulations and to continuously improve the environmental performance by adapting to them.

We think it is a responsibility for leave a livable world for future generations so we are getting electricity from solar energy for our production.



Yetkinlikler

COMPETENCES

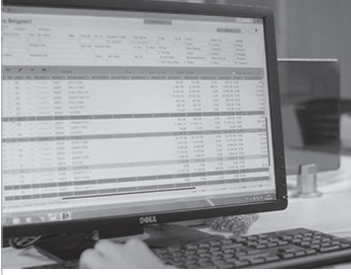

ERP Süreç Takip Sistemi
ERP Process Control System

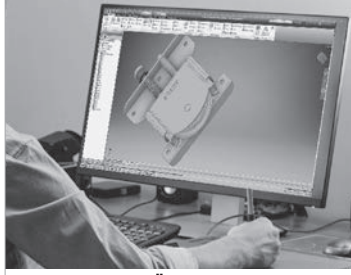

Ar-Ge Ürün Tasarım
R & D Product Design Process



Kalıp Tasarım ve İmalat
Mold Design Manufacturing



CNC Mekanik İşlem
CNC Machining Process



Sac Şekillendirme
Metal Sheet Forming



Kalite Kontrol
Quality Control



Otomasyon Üretim
Automation Production



Plastik Enjeksiyon
Plastic Injection



Robotik Boya Tesisi
Robotics Paint Facility



Ürün Test Süreçleri
Products Test Process



Vibrasyon Hattı
Vibration Line



Alüminyum Profil İşleme
Aluminium Profile Processing



Geniş Ürün Stoklama
Wide Product Stocking



Montaj Prosesleri
Assembly Processes



Mühendislik Süreçleri
Engineering Processes



Robotik Otomasyon Üretim Hattı
Robotic Automation Production Line



Katalog
Catalog



Ürün Montaj Videoları
Product Assembly Videos 3D



Yeşil Enerji
We Care About Green Energy



Fuarlar
Exhibitions



Sertifikasyon
Certification

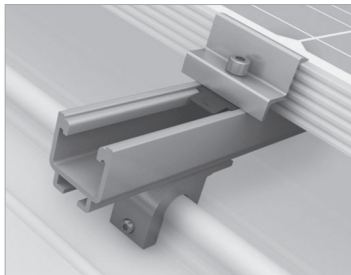

Özel Ürün Geliştirme
Special Product Development



Ürün Standları
Product Stands



İhracat
Export

Belgelerimiz ve Kalite Politikamız

CERTIFICATIONS AND QUALITY POLICY

KALİTE POLİTİKAMIZ

Firmamızın geleceğinin ve ekonomik gelişmesinin ana garantisi müşteri tatminidir. Bu aynı zamanda personel istihdamımızın da kilit faktörüdür. Müşteri tatminini garanti etmenin esas unsurları firmamızın ve tedarikçilerimizin kaliteli olmasıdır. Tüm çalışanlarımızın hareket tarzları ve profesyonellikleri ürünlerimizin kalitesini sağlamanın esasidir. Uzun süreli başarı ekonomik gelişme ve işin devamlılığı sadece başarılı müşteri ilişkileri ile sağlanır. Personel motivasyonu firma hedefidir. Bu firma içinde ve dışında kalite uğraşı verme anlamı taşır. Her çalışan kendi profesyonelliği ve davranışı ile ürün kalitesine katkıda bulunur.

QUALITY POLICY

The main guarantee of our company's future and economical developing is customer satisfication. This is also a key factor in the employment of staff. The main instruments to guarantee customer satisfaction is our company and suppliers of high quality. Conduct and professionalism is the cornerstone of all of our employees to ensure quality of our products. Long-term success in economic development and business continuity is achieved by only a successful customer relationship. The staff motivation is goal of the company. This has the meaning-making within and outside the profession of quality in the company. Each employee contributes to their own professionalism and behavior and product quality.

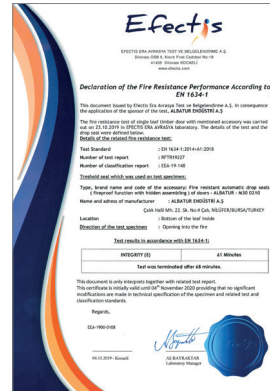
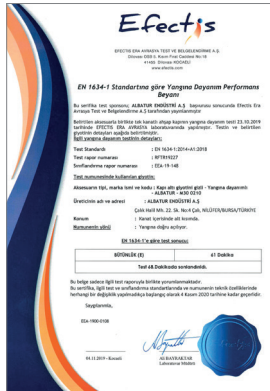

Semboller

SYMBOLS

1  Dolap Sistemi Wardrobe System	2  Kapı Sistemi Door System	3  Teleskopik Kapı Sistemi Telescopic Door System	4  Klasik Kapı Sistemi Classic Door System	5  Çekmece Sistemi Drawer System	6  İçten Sistem Internal System	7  Dıştan Sistem External System
8  Karma Alt Taşıyıcı Combined Bottom Carrier	9  Karma Üst Taşıyıcı Combined Top Carrier	10  Dıştan Tek Kanat External Single Door	11  Üst Taşıyıcı Top Carrier	12  L Kanat L Wing	13  Katlanır Kapak Foldable Cabinet Door	14  Sürme Kapı Sliding Door
15  Sürme Kapı Sliding Door	16  Senkronize Kapı Funicular Door	17  Katlanır Kapı Foldable Door	18  Katlanır Kapı Pivot Foldable Door Pivot	19  Ahşap Wooden	20  Cam Glass	21  Ahşap - Cam Wooden - Glass
22  Ahşap - Metal Wooden - Metal	23  Stoper With Stopper	24  Tek Yöne Yavaşlatıcı Uygulanabilir Apply to one Way Soft Closing	25  Çift Yöne Yavaşlatıcı Uygulanabilir Apply to two Way Soft Closing	26  Panel Kalınlık Panel Thickness	27  Ağırlık Weight	28  Yükseklik Ayarlı Height Adjustable
29  Yatay Ayarlı Horizontal Adjustable	30  Dönüş Açısı Rotation Angel	31  Rüzgar Yalıtım Wind Insulation	32  Hava Geçer Air Pass Through	33  Ses Yalıtım Sound Proof	34  Toz Yalıtım Dust Insulation	35  Işık Yalıtım Özelliği Light Isolation Feature
36  Yangın Dayanımlı Fire Resistance	37  Duman Yalıtım Smoke Proof	38  Enerji Yalıtım Özelliği Energy Isolation Feature	39  Bozuk Yüzeylerde Uygulanabilir Can Be Applied to Faulty Surface	40  Engelli Bireyler İçin Uygundur Suitable For Disabled People	41  Haşere Engeller Pests Prevent	42  Video Video
43  Yağlı Piston Sistemi Oil Damper System	44  Havali Piston Sistemi Air Damper System	45  Kutu İçi Montaj Şeması Prospectus	46  Elektrikli Electrical	47  Set Ambalaj Set Packing	48  Ürün Palet Miktarı Product Pallet Quantity	49  Poşet Ambalaj Bag Packaging
50  Kutu İçi Miktar In-Box Quantity	51  Koli İçi Miktar In-Package Quantity	52  Cam Delik Delme Glass Hole Drilling	53  Alt Kılavuz Bottom Guide	54  Cam Sıkıştırma Glass Compression	55  90 Derece Katlanır Kapı 90 Degree Bi-Folding Door	56  180 Derece Katlanır Kapı 180 Degree Bi-Folding Door

Ürün Grupları

PRODUCT GROUPS

Coplanar®		Hemyüz Sürme Gardırop Serisi Coplanar Sliding Wardrobe Series	Page 10 Group 101
TopSlide®		Sürme Gardırop Serileri Sliding Wardrobe Series	Page 11 Group 102
Multiline®		Sürme Kapak Serisi Sliding Door Series	Page 20 Group 103
WingSlide®		Sürme Katlanır Kapak Serisi Sliding Foldable Door Series	Page 47 Group 105
Glassline®		Sürme Cam Kapak Serisi Sliding Glass Door Series	Page 50 Group 108
Rigel®		Sürme Ray Dolap Serisi Sliding Rail Wardrobe Series	Group 109
TvSlide®		Sürme Tv Ünite Serisi Sliding Tv Unit Series	Group 110
Softline®		Yavaşlatıcı Serisi Soft Closers Series	Page 52 Group 117
Pulltens®		Çek-Ger Serisi Pull & Tension Series	Page 56 Group 118
BarnDoor®		BarnDoor Sürme Kapı Serisi BarnDoor Sliding Door Series	Page 58 Group 119
DoorSlide®		Ahşap Sürme Kapı Serisi Wooden Sliding Door Series	Page 64 Group 120
DoorSync®Wood		Ahşap Senkronize Sürme Kapı Serisi Wooden Funicular Sliding Door Series	Page 76 Group 121

MasterFold® MidFold®		Ahşap Katlanır Sürme Kapı Serisi Wooden Foldable Sliding Door Series	Page 80 Group 122
GlassDoor®		Cam Sürme Kapı Serisi Glass Door Sliding Series	Page 88 Group 123
DoorSync®Glass		Cam Senkronize Sürme Kapı Serisi Funicular Glass Door Series	Page 92 Group 124
MultiDoor®		Teleskopik Ahşap Sürme Kapı Serisi Telescopic Wooden Sliding Door Series	Page 94 Group 127
Underline®		Kapı Altı Giyotin Serisi Door Seal Series	Page 98 Group 130
Domino®		Kapı Donanımları Serisi Door Hardware Series	Page 100 Group 131
MagicLift®		Gardırop Donanımları Serisi Wardrobe Equipments Series	Page 106 Group 135
Ventil®Aluminium		Alüminyum Dekoratif Menfez Serisi Aluminium Air Ventilation Cover Series	Page 107 Group 140
Ventil®Plastic		Plastik Dekoratif Menfez Serisi Plastic Air Ventilation Cover Series	Page 110 Group 141
TurnTable®		Döner Tabla Mekanizma Serisi Swivel Plate - Turnable Table Series	Page 112 Group 142
link+		Panel Bileşenleri Panel Component	Page 114 Group 143
Feet		Koltuk ve Baza Ayakları Serisi Furniture Feet Series	Group 144

Coplanar 8888

GARDIROP HEMYÜZ SÜRME KAPAK SİSTEMİ • COPLANAR SLIDING WARDROBE SYSTEM



Bilgi / Information

- Kapak yüksekliği 220 cm önerilir.
- Maksimum 40 kg / 1 kapak.
- Tek kanat uygulamalar için lütfen müşteri temsilciniz ile görüşünüz.

- Max. height of 220 cm is suitable for wardrobes.
- Maximum 40 kg / 1 door.
- For one wing applications please contact.

Yavaşlatıcı Alternatifi / Soft Closer Alternative

- Sistem üzerinde kapanış yönünde yavaşlatıcı mevcuttur.
- Sisteme haricen yavaşlatıcı uygulanamamaktadır.
- Soft closer is available in the direction of closing on the system.
- Soft closer can not be applied to the system.



8888 1 Set İçeriği / 1 Set Includes

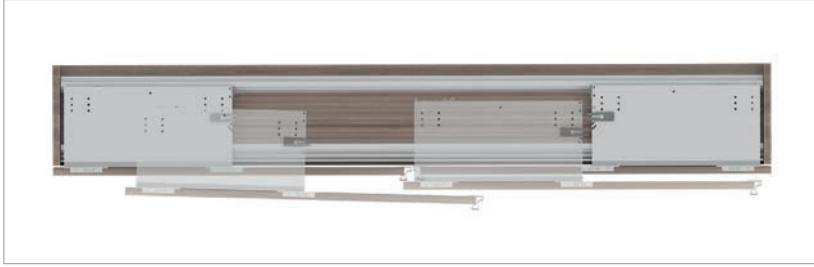

Kulp Profilleri / Handle Profiles

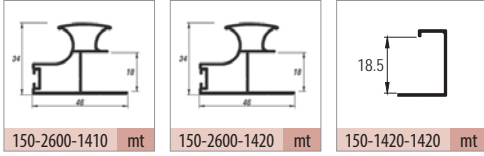

Opsiyonel Aksesuar / Optional Accessories

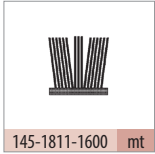

Teknik Detay / Technical Detail

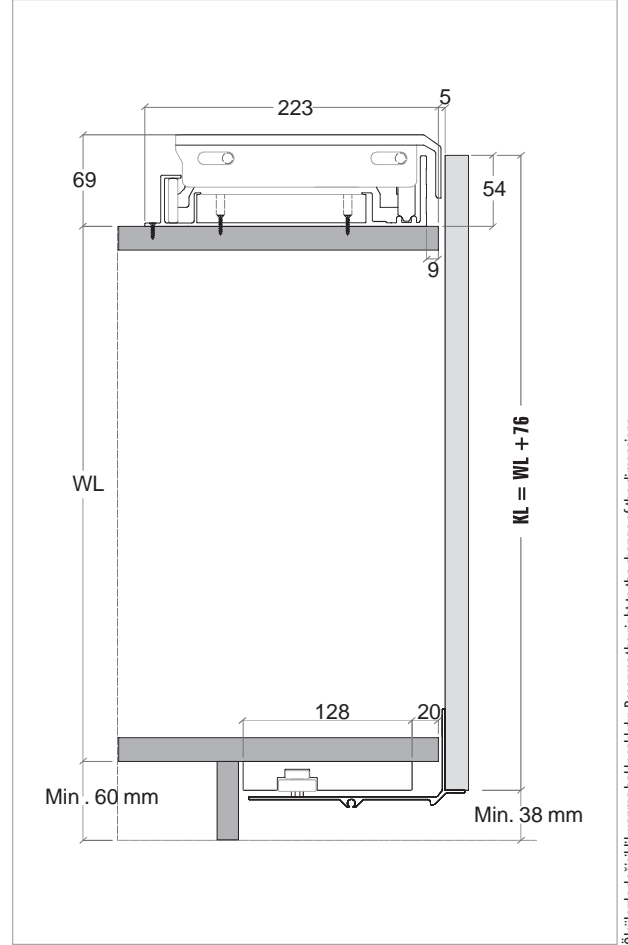

Ölçülerde değişiklik yapma hakkı saklıdır. Reserves the right to the change of the dimensions.

Kod / Code No	Açıklama / Description	Renk / Colour	Birim / Unit			Profil mt. / Profiles mt.	Bağ / Bnd.
101-8888-3410-1600	Sürme Gardirop Sistemi / Coplanar Sliding Wardrobe System / 1600 mm	Gri / Grey	2 Kapak / 1 Set	1	12	- - -	-
101-8888-3410-1800	Sürme Gardirop Sistemi / Coplanar Sliding Wardrobe System / 1800 mm	Gri / Grey	2 Kapak / 1 Set	1	12	- - -	-
101-8888-3410-2000	Sürme Gardirop Sistemi / Coplanar Sliding Wardrobe System / 2000 mm	Gri / Grey	2 Kapak / 1 Set	1	12	- - -	-
101-8888-3410-2200	Sürme Gardirop Sistemi / Coplanar Sliding Wardrobe System / 2200 mm	Gri / Grey	2 Kapak / 1 Set	1	12	- - -	-
101-8888-3410-2400	Sürme Gardirop Sistemi / Coplanar Sliding Wardrobe System / 2400 mm	Gri / Grey	2 Kapak / 1 Set	1	12	- - -	-
145-1811-1600	Kıl Fital / Ec-Wf Hair Wick	Gri / Grey	mt.	300	7.200	- - 3,0	-
150-2600-1410	Alüminyum Kulp Profili / Aluminium Handle Profile	Eloksal / Mat Anodized	mt.	-	-	- - 3,0	6 ad/pcs
150-2600-1420	Alüminyum Kulp Profili / Aluminium Handle Profile	Parlak / Bright	mt.	-	-	- - 3,0	6 ad/pcs
150-1420-1420	Alüminyum Kapama Profili / Aluminium Closure Profile	Parlak / Bright	mt.	-	-	- - 3,0	10 ad/pcs

TopSlide 8220

100 KG SÜRME GARDIROP SİSTEMİ • SLIDING WARDROBE SYSTEM



Bilgi / Information

- 1 Kutu İçeriği : 1 iç kapak + 1 dış kapak + 4 ad üst yavaşlatıcı + 4 ad alt yavaşlatıcı
- In 1 box : 1 internal door + 1 external door + 4 pcs Top soft closers + 4 pcs bottom soft closers



8220 1 Set İçeriği / 1 Set Includes



8203 Opsiyonel 3. İç Kapak / Optional 3. Internal Door

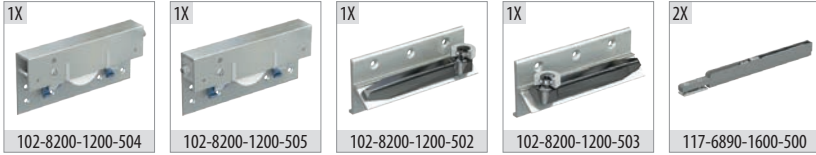

Ray Profilleri / Rail Profiles

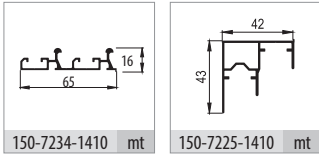

Kulp Profilleri / Handle Profiles

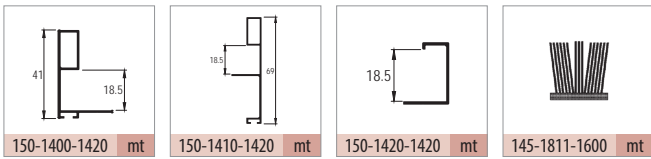

Teknik Detay / Technical Detail

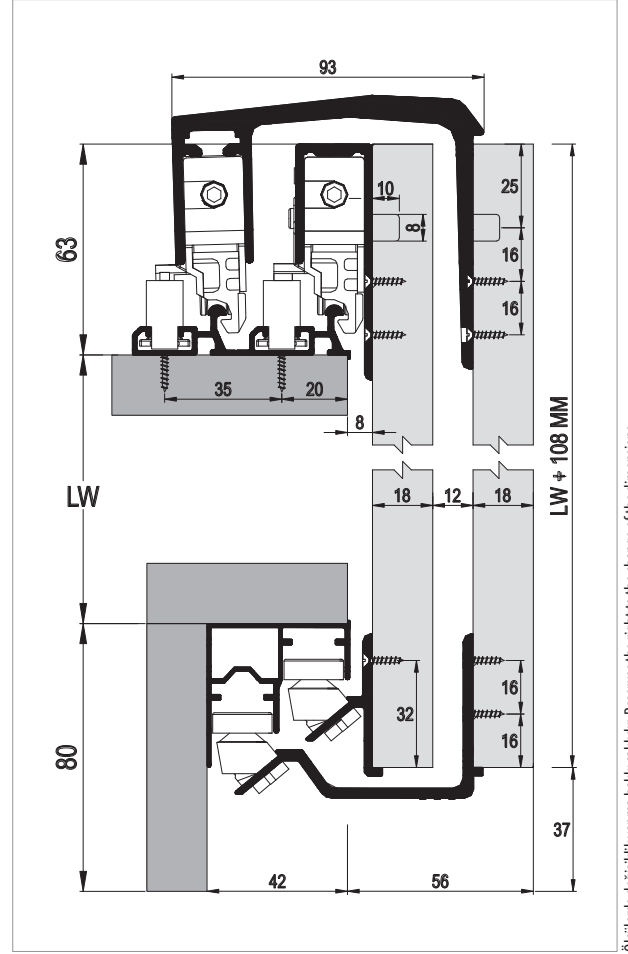

Ölçülerde değişiklik yapma hakkı saklıdır. Reserves the right to the change of the dimensions.

Kod / Code No	Açıklama / Description	Renk / Colour	Birim / Unit			Profil mt. / Profiles mt.	Bağ / Bnd.
102-8220-1200	Sürme Gardirop Sistemi / Sliding Wardrobe System	Silver	2 Kapak / 1 Set	6	144	-	-
102-8203-1200	Sürme Gardirop Sistemi 3. Kapak / Sliding Wardrobe System 3. Door	Silver	1 Kapak / 1 Kit	8	400	-	-
145-1811-1600	Kıl Fital / Ec-Wf Hair Wick	Gri / Grey	mt.	300	7.200	-	-
150-7234-1410	Alüminyum Üst Ray Profili / Aluminium Top Rail Profile	Eloksal / Mat Anodized	mt.	-	-	2,0	2,5
150-7225-1410	Alüminyum Alt Ray Profili / Aluminium Bottom Rail Profile	Eloksal / Mat Anodized	mt.	-	-	2,0	2,5
150-1400-1420	Alüminyum Kulp Profili / Aluminium Handle Profile	Parlak / Bright	mt.	-	-	-	2,7
150-1410-1420	Alüminyum Kulp Profili / Aluminium Handle Profile	Parlak / Bright	mt.	-	-	-	2,7
150-1420-1420	Alüminyum Kapama Profili / Aluminium Closure Profile	Parlak / Bright	mt.	-	-	-	3,0

TopSlide 8232

100 KG SÜRME GARDIROP SİSTEMİ • SLIDING WARDROBE SYSTEM



Bilgi / Information

- 1 Kutu İçeriği : 1 iç kapak + 1 dış kapak + 4 ad üst yavaşlatıcı + 4 ad alt yavaşlatıcı
- In 1 box : 1 internal door + 1 external door + 4 pcs Top soft closers + 4 pcs bottom soft closers



8232 1 Set İçeriği / 1 Set Includes

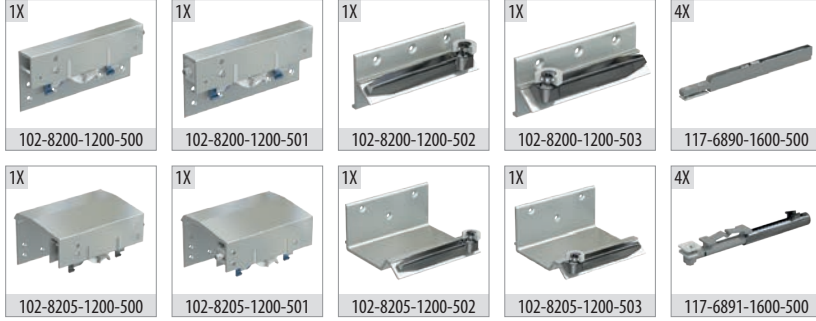

8203 Opsiyonel 3. İç Kapak / Optional 3. Internal Door

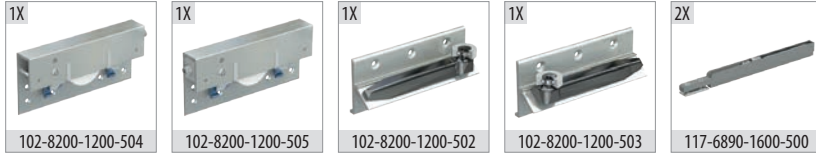

Ray Profilleri / Rail Profiles

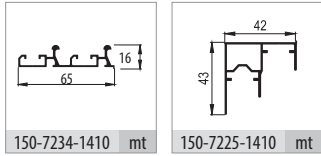

Aksesuar / Accessory

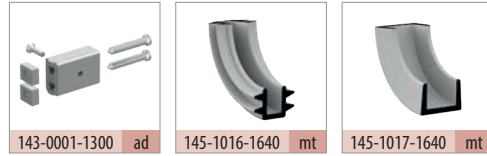

Kulp Profilleri / Handle Profiles

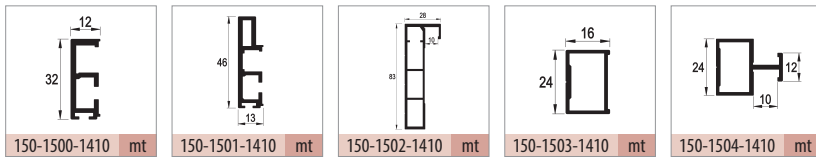

Teknik Detay / Technical Detail

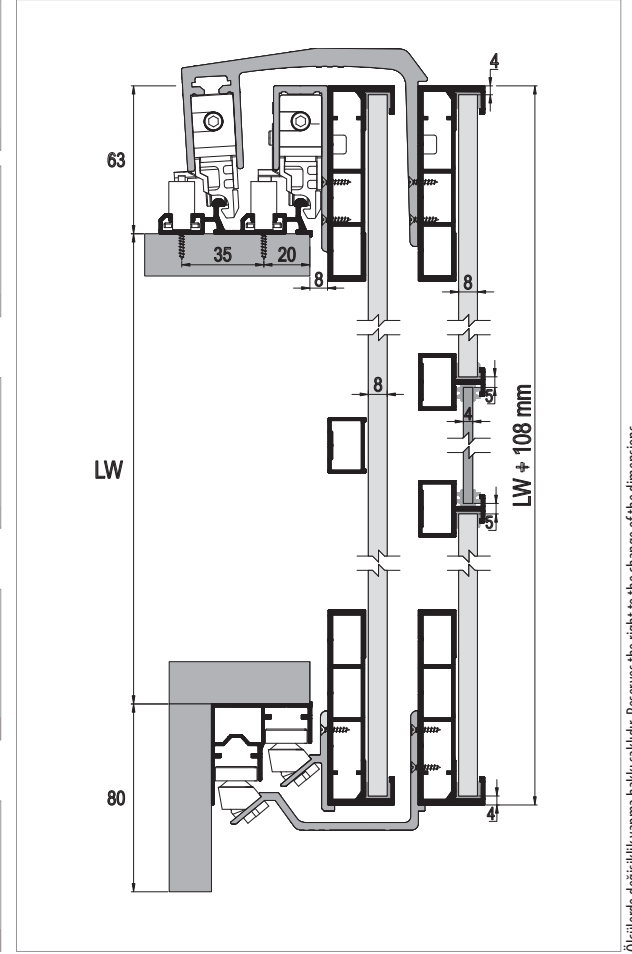

Ölçülerde değişiklik yapma hakkı saklıdır. Reserves the right to the change of the dimensions.

Kod / Code No	Açıklama / Description	Renk / Colour	Birim / Unit			Profil mt. / Profiles mt.	Bağ / Bnd.
102-8232-1200	Sürme Gardirop Sistemi / Sliding Wardrobe System	Silver	2 Kapak / 1 Set	6	144	- - -	-
102-8203-1200	Sürme Gardirop Sistemi 3. Kapak / Sliding Wardrobe System 3. Door	Silver	1 Kapak / 1 Kit	8	400	- - -	-
143-0001-1300	Bağlantı Kiti / Connection Kit	Silver	1 Adet / 1 Pcs			- - -	-
145-1016-1640	4 mm Cam Fiteli / 4 mm Glass Wick	Şeffaf / Transparan	mt.	100	3.600	- - -	-
145-1017-1640	8 mm Sunta Fiteli / 8 mm Panel Wick	Şeffaf / Transparan	mt.	100	3.600	- - -	-
150-7234-1410	Alüminyum Üst Ray Profili / Aluminium Top Rail Profile	Eloksal / Mat Anodized	mt.	-	-	2,0 2,5 3,0	6 ad/pcs
150-7225-1410	Alüminyum Alt Ray Profili / Aluminium Bottom Rail Profile	Eloksal / Mat Anodized	mt.	-	-	2,0 2,5 3,0	6 ad/pcs
150-1500-1410	Alüminyum Çerçeve Profili / Aluminium Frame Profile	Eloksal / Mat Anodized	mt.	-	-	- - 3,0	6 ad/pcs
150-1501-1410	Alüminyum Çerçeve Profili / Aluminium Frame Profile	Eloksal / Mat Anodized	mt.	-	-	- - 3,0	6 ad/pcs
150-1502-1410	Alüminyum Çerçeve Profili / Aluminium Frame Profile	Eloksal / Mat Anodized	mt.	-	-	- - 3,0	4 ad/pcs
150-1503-1410	Alüminyum Çerçeve Profili / Aluminium Frame Profile	Eloksal / Mat Anodized	mt.	-	-	- - 3,0	12 ad/pcs
150-1504-1410	Alüminyum Çerçeve Profili / Aluminium Frame Profile	Eloksal / Mat Anodized	mt.	-	-	- - 3,0	6 ad/pcs

TopSlide 8235

100 KG SÜRME GARDIROP SİSTEMİ • SLIDING WARDROBE SYSTEM



Bilgi / Information

- 1 Kutu İçeriği : 1 iç kapak + 1 dış kapak + 4 ad üst yavaşlatıcı + 4 ad alt yavaşlatıcı
- In 1 box : 1 internal door + 1 external door + 4 pcs Top soft closers + 4 pcs bottom soft closers



8235 1 Set İçeriği / 1 Set Includes

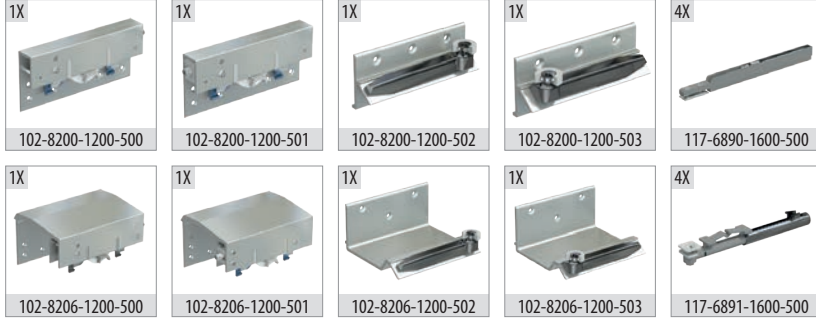

8203 Opsiyonel 3. İç Kapak / Optional 3. Internal Door

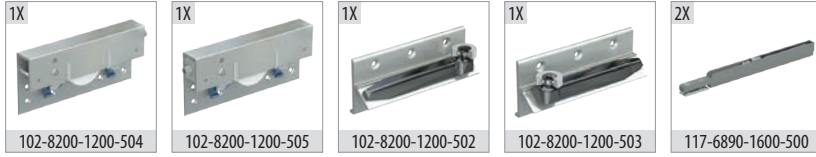

Ray Profilleri / Rail Profiles

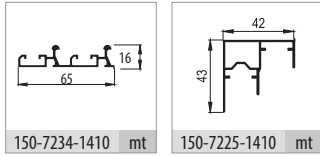

Uygulama / Application



Teknik Detay / Technical Detail

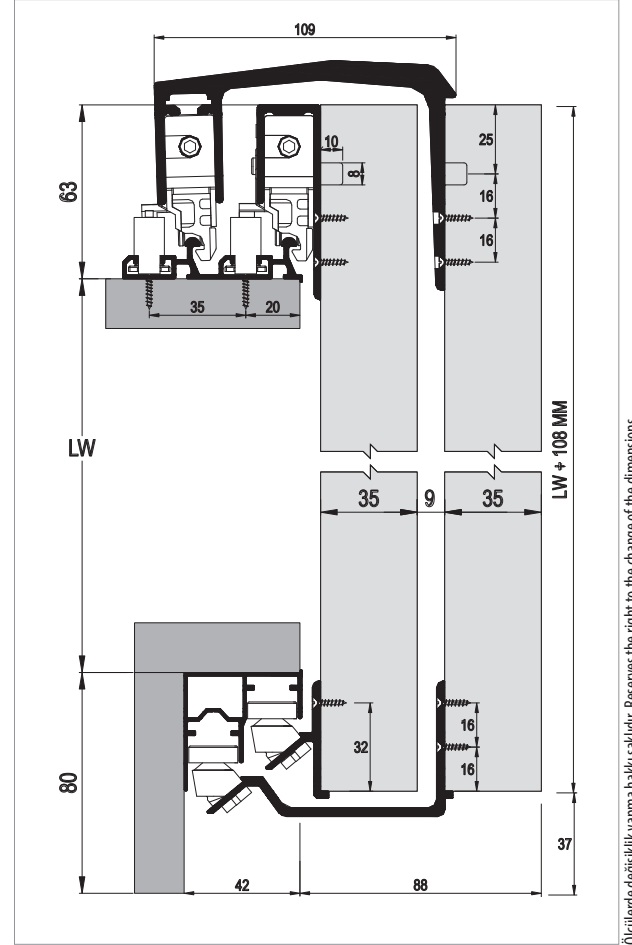

Ölçülerde değişiklik yapma hakkı saklıdır. Reserves the right to the change of the dimensions.

Kod / Code No	Açıklama / Description	Renk / Colour	Birim / Unit			Profil mt. / Profiles mt.	Bağ / Bnd.
102-8235-1200	Sürme Gardrop Sistemi / Sliding Wardrobe System	Silver	2 Kapak / 1 Set	6	144	- - -	-
102-8203-1200	Sürme Gardrop Sistemi 3. Kapak / Sliding Wardrobe System 3. Door	Silver	1 Kapak / 1 Kit	8	400	- - -	-
150-7234-1410	Alüminyum Üst Ray Profili / Aluminium Top Rail Profile	Eloksal / Mat Anodized	mt.	-	-	2,0 2,5 3,0	6 ad/pcs
150-7225-1410	Alüminyum Alt Ray Profili / Aluminium Bottom Rail Profile	Eloksal / Mat Anodized	mt.	-	-	2,0 2,5 3,0	6 ad/pcs

TopSlide 8250

100 KG SÜRME GARDIROP SİSTEMİ • SLIDING WARDROBE SYSTEM



Bilgi / Information

- 1 Kutu İçeriği : 1 iç kapak + 1 dış kapak + 4 ad üst yavaşlatıcı + 4 ad alt yavaşlatıcı
- In 1 box : 1 internal door + 1 external door + 4 pcs Top soft closers + 4 pcs bottom soft closers



8250 1 Set İçeriği / 1 Set Includes

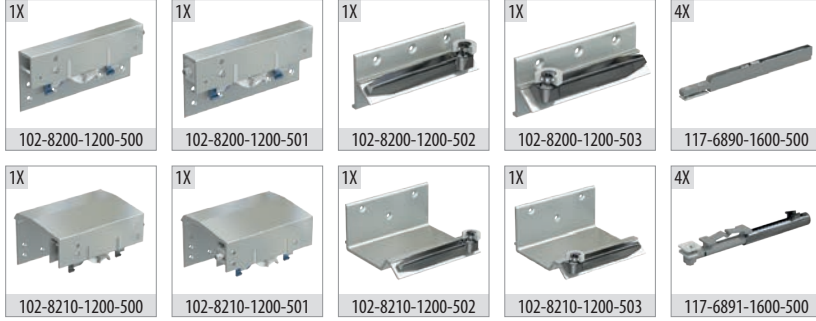

8203 Opsiyonel 3. İç Kapak / Optional 3. Internal Door

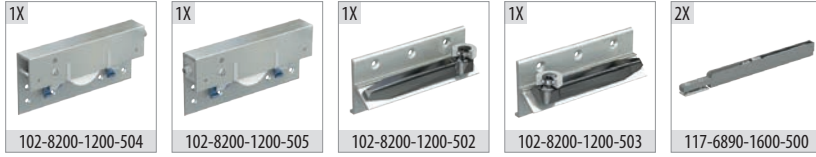

Ray Profilleri / Rail Profiles

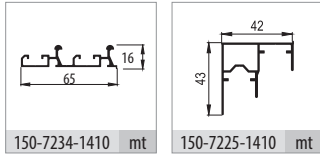

Uygulama / Application



Teknik Detay / Technical Detail

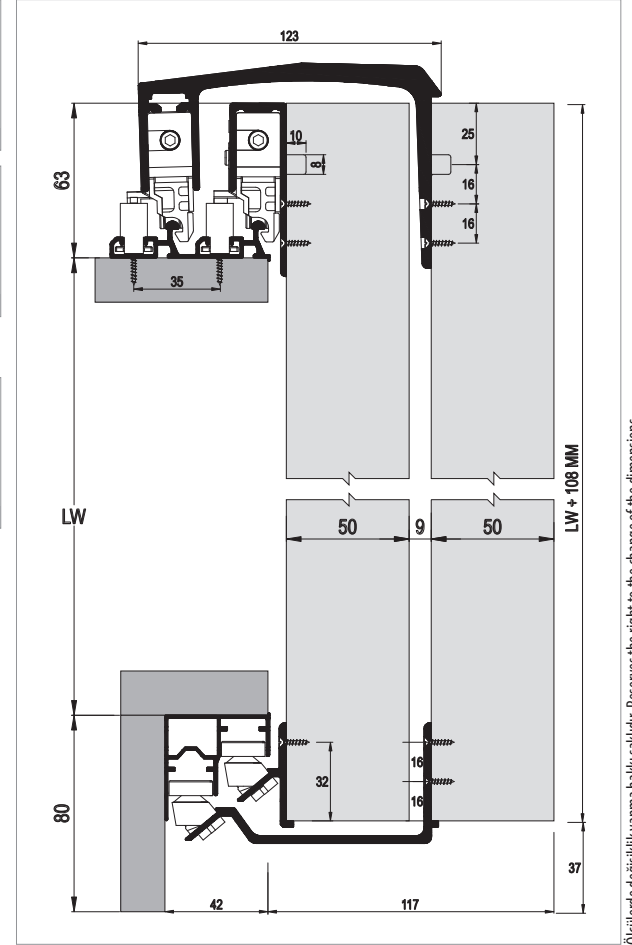

Ölçülerde değişiklik yapma hakkı saklıdır. Reserves the right to the change of the dimensions.

Kod / Code No	Açıklama / Description	Renk / Colour	Birim / Unit			Profil mt. / Profiles mt.			Bağ / Bnd.
102-8250-1200	Sürme Gardrop Sistemi / Sliding Wardobe System	Silver	2 Kapak / 1 Set	6	144	-	-	-	-
102-8203-1200	Sürme Gardrop Sistemi 3. Kapak / Sliding Wardobe System 3. Doo	Silver	1 Kapak / 1 Kit	8	400	-	-	-	-
150-7234-1410	Alüminyum Üst Ray Profili / Aluminium Top Rail Profile	Eloksal / Mat Anodized	mt.	-	-	2,0	2,5	3,0	6 ad/pcs
150-7225-1410	Alüminyum Alt Ray Profili / Aluminium Bottom Rail Profile	Eloksal / Mat Anodized	mt.	-	-	2,0	2,5	3,0	6 ad/pcs



Bilgi / Information

- 1 Kutu İçeriği : 2 iç kapak + 1 dış kapak + 7 ad üst yavaşlatıcı + 4 ad alt yavaşlatıcı
- 8223 Sürgü sisteminde dış kapak çift yöne çalışmakta ve yavaşlatıcı özelliği bulunmaktadır.
- In 1 box : 2 internal door + 1 external door + 7 pcs Top soft closers + 4 pcs bottom soft closers.
- 8223 In this sliding system external door running two way and the system has soft closing function.



8223 1 Set İçeriği / 1 Set Includes



Ray Profilleri / Rail Profiles

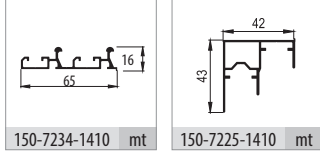

Kulp Profilleri / Handle Profiles

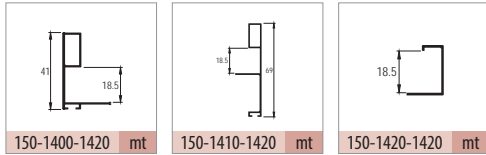

Opsiyonel Aksesuar / Optional Accessories

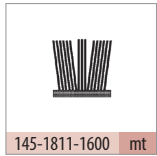

Teknik Detay / Technical Detail

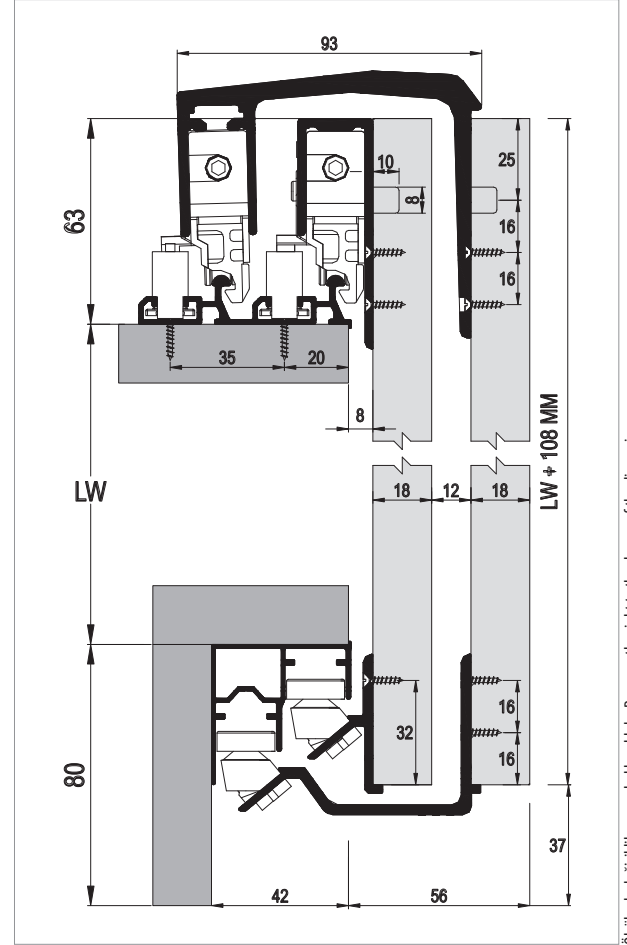

Ölçülerde değişiklik yapma hakkı saklıdır. Reserves the right to the change of the dimensions.

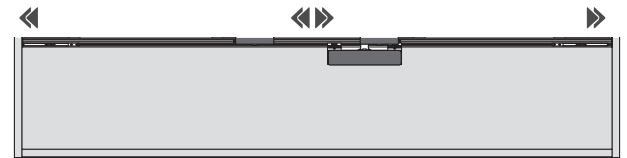

Kod / Code No	Açıklama / Description	Renk / Colour	Birim / Unit			Profil mt. / Profiles mt.	Bağ / Bnd.
102-8223-1200	Sürme Gardrop Sistemi / Sliding Wardrobe System	Silver	3 Kapak / 1 Set	5	90	- - -	-
145-1811-1600	Kıl Fital / Ec-Wf Hair Wick	Gri / Grey	mt.	300	7.200	- - -	-
150-7234-1410	Alüminyum Üst Ray Profili / Aluminium Top Rail Profile	Eloksal / Mat Anodized	mt.	-	-	2,0 2,5 3,0	6 ad/pcs
150-7225-1410	Alüminyum Alt Ray Profili / Aluminium Bottom Rail Profile	Eloksal / Mat Anodized	mt.	-	-	2,0 2,5 3,0	6 ad/pcs
150-1400-1420	Alüminyum Kulp Profili / Aluminium Handle Profile	Parlak / Bright	mt.	-	-	- 2,70 -	10 ad/pcs
150-1410-1420	Alüminyum Kulp Profili / Aluminium Handle Profile	Parlak / Bright	mt.	-	-	- 2,70 -	10 ad/pcs
150-1420-1420	Alüminyum Kapama Profili / Aluminium Closure Profile	Parlak / Bright	mt.	-	-	- - 3,0	10 ad/pcs

TopSlide 8030

60 KG SÜRME GARDİROP SİSTEMİ • SLIDING WARDROBE SYSTEM



Yavaşlatıcı Alternatifi / Soft Closer Alternative

117-6711-1610 ➔



8030 İç Kapak 1 Takım İçeriği / Internal Door 1 Kit Includes



8032 Dış Kapak 1 Takım İçeriği / External Door 1 Kit Includes

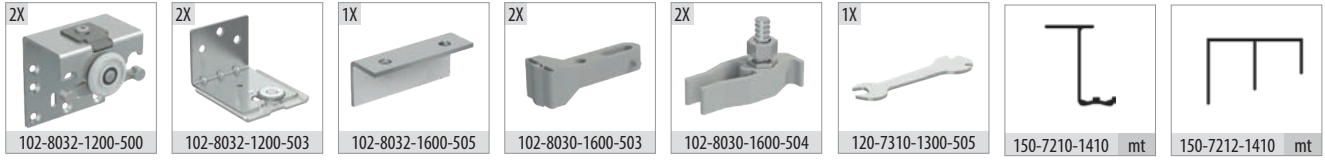

Ray Profilleri / Rail Profiles

6711 Yavaşlatıcı Bağlantı Kiti / Soft Closing Connection Kit

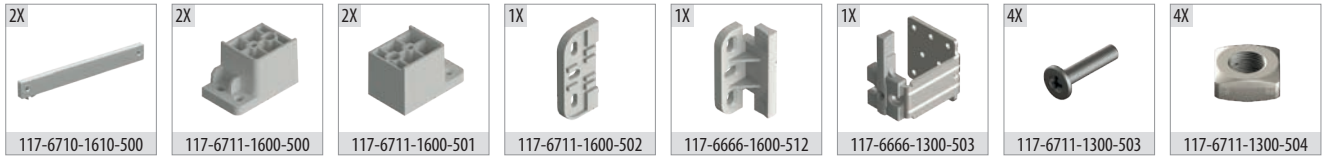

Teknik Detay / Technical Detail

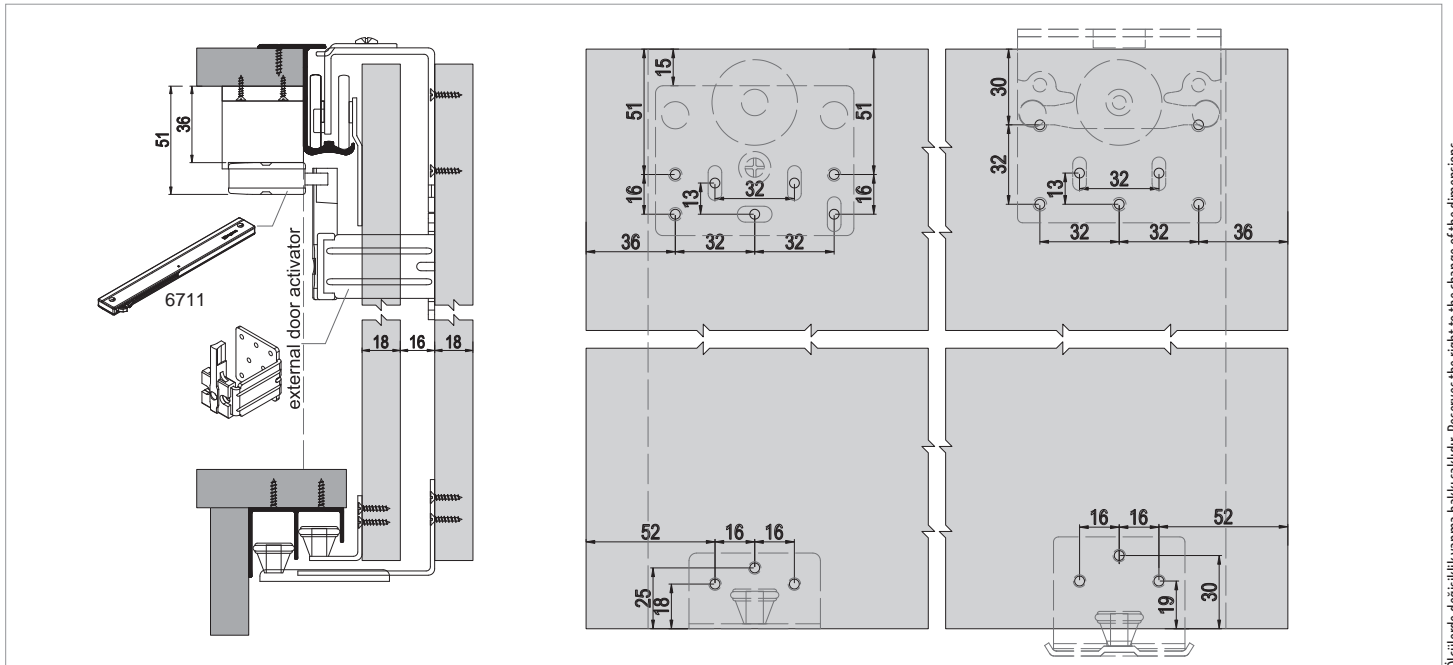

Ölçülerde değişiklik yapma hakkı saklıdır. Reserves the right to the change of the dimensions.

Kod / Code No	Açıklama / Description	Renk / Colour	Birim / Unit			Profil mt. / Profiles mt.	Bağ / Bnd.
102-8030-1300	Sürme Gardirop Sistemi İç Kapak / Sliding Wardrobe System Internal Door	Silver	1 Kapak / 1 Kit	24	768	-	-
102-8032-1200	Sürme Gardirop Sistemi Dış Kapak / Sliding Wardrobe System External Door	Silver	1 Kapak / 1 Kit	24	384	-	-
117-6711-1610	100 Kg Yavaşlatıcı Sistem / 100 Kg Soft Closers	Gri / Grey	1 Takım / 1 Kit	20	480	-	-
150-7210-1410	Alüminyum Üst Ray Profili / Aluminium Top Rail Profile	Eloksal / Mat Anodized	mt.	-	-	-	3,0 6 ad/pcs
150-7212-1410	Alüminyum Alt Ray Profili / Aluminium Bottom Rail Profile	Eloksal / Mat Anodized	mt.	-	-	-	3,0 6 ad/pcs

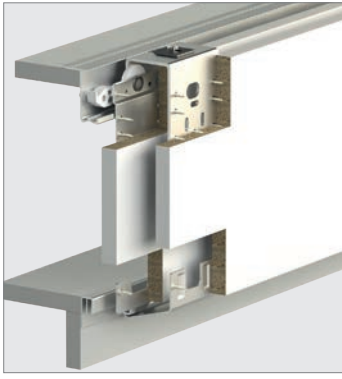

Yavaşlatıcı Alternatifi / Soft Closer Alternative

117-6711-1610 ►►



8400 İç Kapak 1 Takım İçeriği / Internal Door 1 Kit Includes

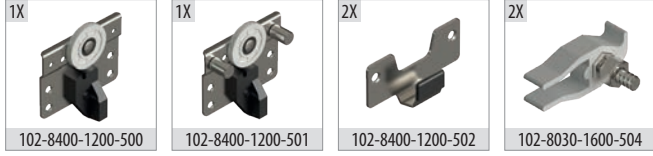

8402 Dış Kapak 1 Takım İçeriği / External Door 1 Kit Includes

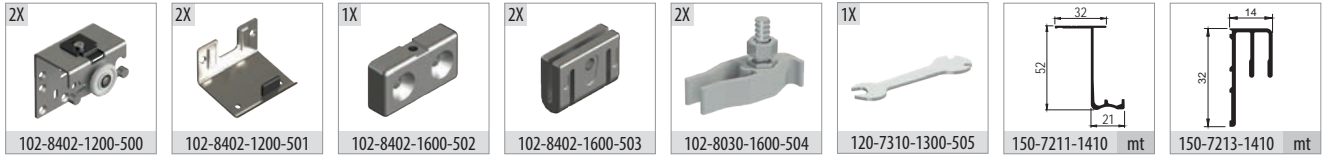

Ray Profilleri / Rail Profiles

6711 Yavaşlatıcı Bağlantı Kiti / Soft Closing Connection Kit

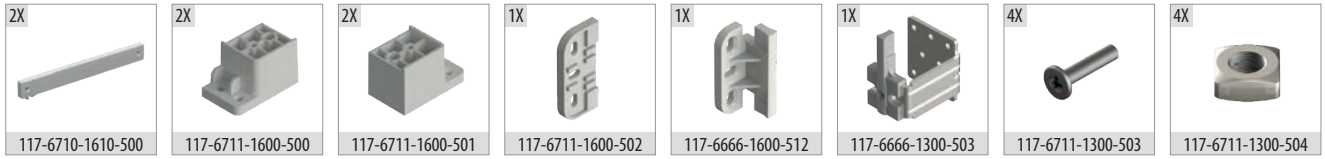

Teknik Detay / Technical Detail

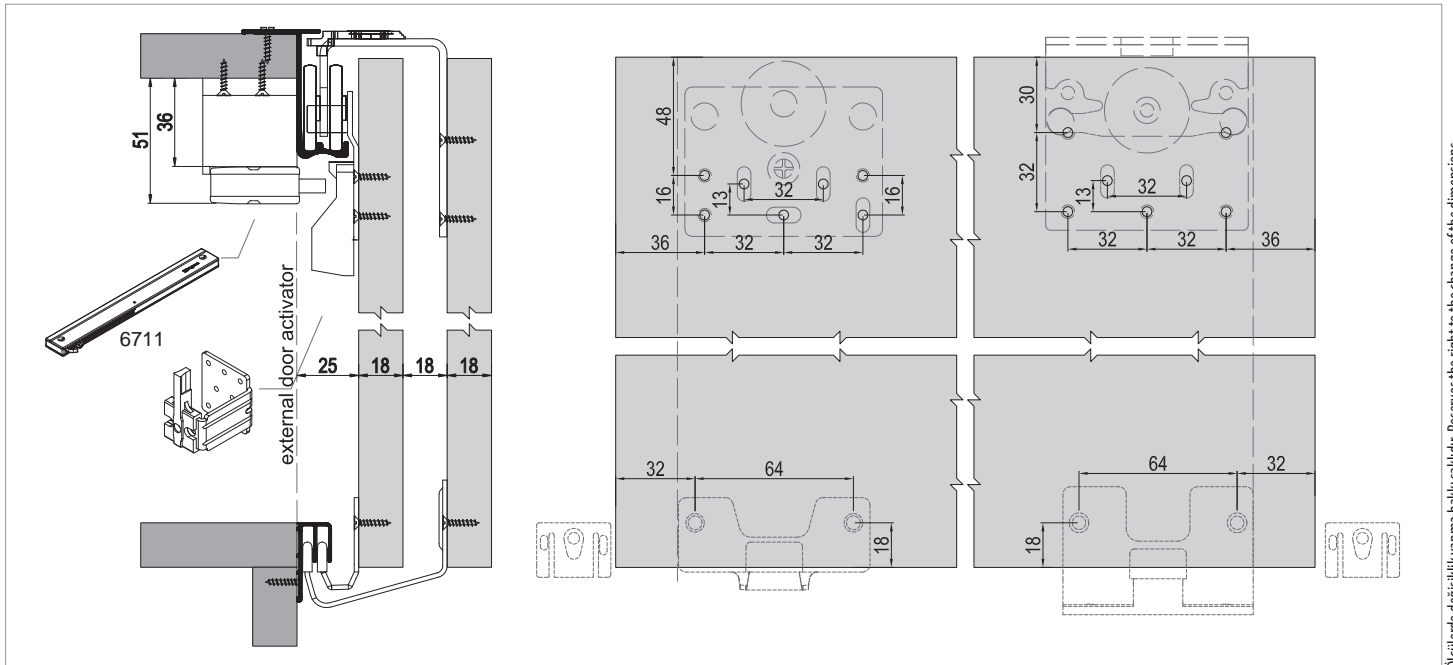

Ölçülerde değişiklik yapma hakkı saklıdır. Reserves the right to the change of the dimensions.

Kod / Code No	Açıklama / Description	Renk / Colour	Birim / Unit			Profil mt. / Profiles mt.	Bağ / Bnd.
102-8400-1300	Sürme Gardirop Sistemi İç Kapak / Sliding Wardrobe System Internal Door	Silver	1 Kapak / 1 Kit	24	768	- - -	-
102-8402-1200	Sürme Gardirop Sistemi Dış Kapak / Sliding Wardrobe System External Door	Silver	1 Kapak / 1 Kit	12	384	- - -	-
117-6711-1610	100 Kg Yavaşlatıcı Sistem / 100 Kg Soft Closers	Gri / Grey	1 Takım / 1 Kit	20	480	- - -	-
150-7211-1410	Alüminyum Üst Ray Profili / Aluminium Top Rail Profile	Eloksal / Mat Anodized	mt.	-	-	- - 3,0	6 ad/pcs
150-7213-1410	Alüminyum Alt Ray Profili / Aluminium Bottom Rail Profile	Eloksal / Mat Anodized	mt.	-	-	- - 3,0	6 ad/pcs

TopSlide 8040

70 KG SÜRME GARDIROP SİSTEMİ • SLIDING WARDROBE SYSTEM

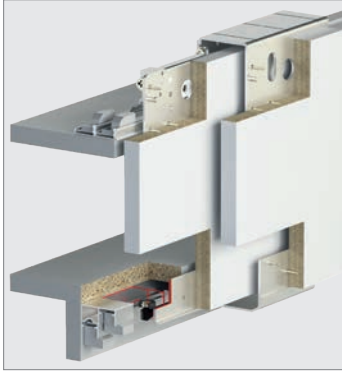

Yavaşlatıcı Alternatifi / Soft Closer Alternative

117-6666-1610 ►► 117-6710-1610 ►►



8040 İç Kapak 1 Takım İçeriği / Internal Door 1 Kit Includes

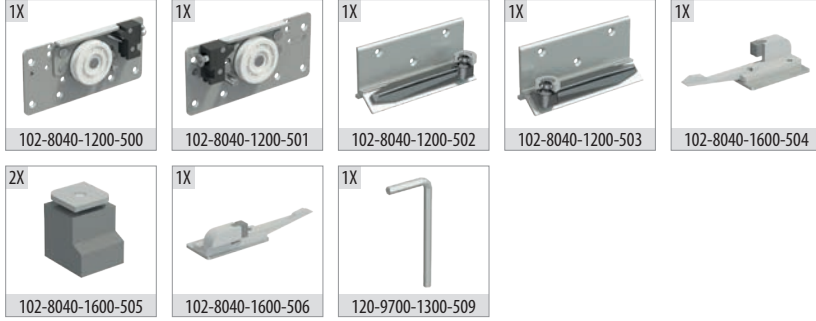

8042 Dış Kapak 1 Takım İçeriği / External Door 1 Kit Includes

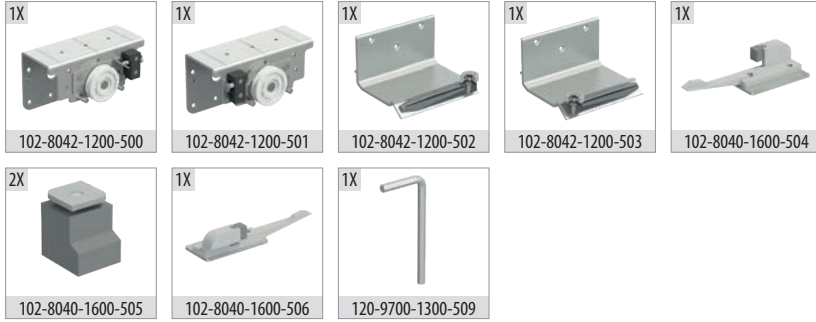

Ray Profilleri / Rail Profiles

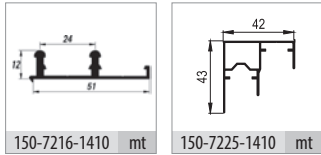

Kulp Profilleri / Handle Profiles

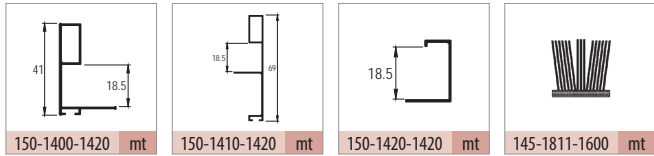

Teknik Detay / Technical Detail

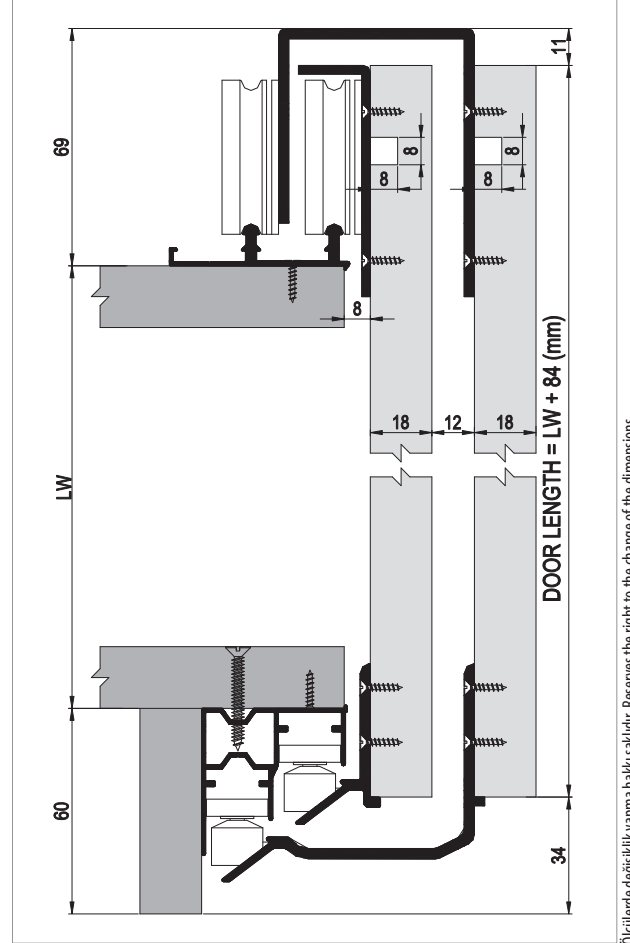

Ölçülerde değişiklik yapma hakkı saklıdır. Reserves the right to the change of the dimensions.

Kod / Code No	Açıklama / Description	Renk / Colour	Birim / Unit			Profil mt. / Profiles mt.			Bağ / Bnd.
102-8040-1200	Sürme Gardirop Sistemi İç Kapak / Sliding Wardrobe System Internal Door	Silver	1 Kapak / 1 Kit	16	384	-	-	-	-
102-8042-1200	Sürme Gardirop Sistemi Dış Kapak / Sliding Wardrobe System External Door	Silver	1 Kapak / 1 Kit	12	288	-	-	-	-
150-7216-1410	Alüminyum Üst Ray Profili / Aluminium Top Rail Profile	Eloksal / Mat Anodized	mt.	-	-	2,0	2,5	3,0	6 ad/pcs
150-7225-1410	Alüminyum Alt Ray Profili / Aluminium Bottom Rail Profile	Eloksal / Mat Anodized	mt.	-	-	2,0	2,5	3,0	6 ad/pcs
150-1400-1420	Alüminyum Kulp Profili / Aluminium Handle Profile	Parlak / Bright	mt.	-	-	-	2,70	-	10 ad/pcs
150-1410-1420	Alüminyum Kulp Profili / Aluminium Handle Profile	Parlak / Bright	mt.	-	-	-	2,70	-	10 ad/pcs
150-1420-1420	Alüminyum Kapama Profili / Aluminium Closure Profile	Parlak / Bright	mt.	-	-	-	-	3,0	10 ad/pcs
145-1811-1600	Kıl Fitol / Ec-Wf Hair Wick	Gri / Grey	mt.	300	7.200	-	-	-	-

TopSlide SRG 190

70 KG SÜRME GARDİROP SİSTEMİ • SLIDING WARDROBE SYSTEM

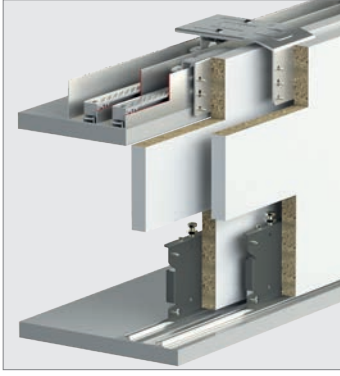

Bilgi / Information

- 1 Kutu İçeriği : 1 iç kapak + 1 dış kapak + 4 ad yavaşlatıcı
- In 1 box : 1 internal door + 1 external door + 4 pcs soft closers



SRG 190 1 Set İçeriği / 1 Set Includes

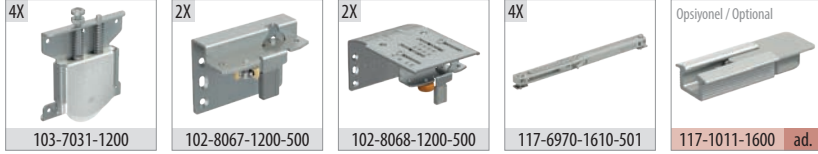

SRG 193 Opsiyonel 3. İç Kapak / Optional 3. Internal Door

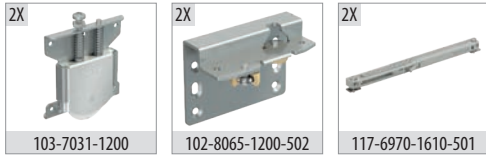

Ray Profilleri / Rail Profiles

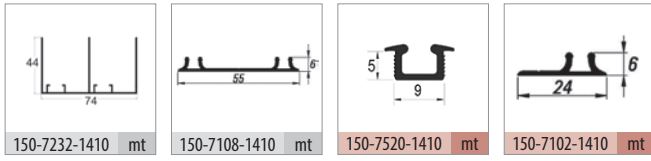

Kulp Profilleri / Handle Profiles

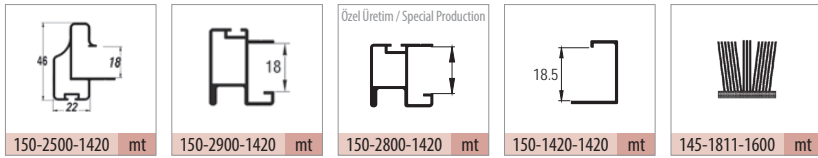

Teknik Detay / Technical Detail

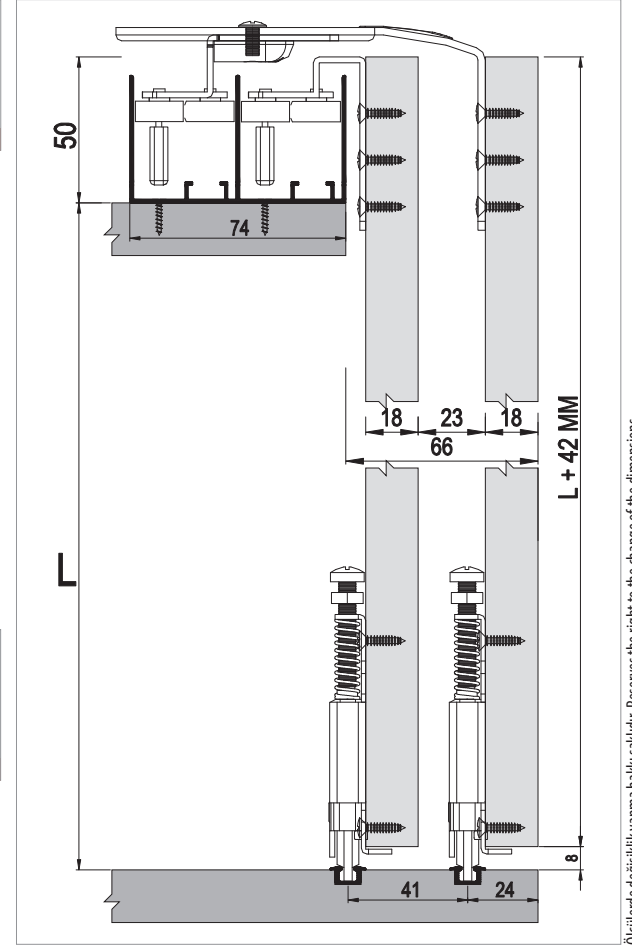

Ölçülerde değişiklik yapma hakkı saklıdır. Reserves the right to the change of the dimensions.

Kod / Code No	Açıklama / Description	Renk / Colour	Birim / Unit			Profil mt. / Profiles mt.	Bağ / Bnd.
102-0190-1200	SRG 190 - Sürme Gardirop Sistemi / SRG 190 - Sliding Wardrobe System	Silver	2 Kapak / 1 Set	12	216	- - -	-
102-0193-1200	SRG 190 C - Sürme Gardirop Sistemi 3. Kapak / Sliding Wardrobe System 3. Door	Silver	1 Kapak / 1 Kit	12	360	- - -	-
145-1811-1600	Kıl Fital / Ec-Wf Hair Wick	Gri / Grey	mt.	300	7.200	- - -	-
150-7232-1410	Alüminyum Üst Ray Profili / Aluminium Top Rail Profile	Eloksal / Mat Anodized	mt.	-	-	2,0 2,5 3,0	6 ad/pcs
150-7108-1410	Alüminyum Alt Ray Profili / Aluminium Bottom Rail Profile	Eloksal / Mat Anodized	mt.	-	-	2,0 2,5 3,0	12 ad/pcs
150-7520-1410	Alüminyum Alt Ray Profili / Aluminium Bottom Rail Profile	Eloksal / Mat Anodized	mt.	-	-	- - 3,0	30 ad/pcs
150-7102-1410	Alüminyum Alt Ray Profili / Aluminium Bottom Rail Profile	Eloksal / Mat Anodized	mt.	-	-	- - 3,0	20 ad/pcs
150-2500-1420	Alüminyum Kulp Profili / Aluminium Handle Profile	Parlak / Bright	mt.	-	-	2,0 - 3,0	6 ad/pcs
150-2900-1420	Alüminyum Kulp Profili / Aluminium Handle Profile	Parlak / Bright	mt.	-	-	2,0 2,5 3,0	6 ad/pcs
150-2800-1420	Alüminyum Kulp Profili / Aluminium Handle Profile	Parlak / Bright	mt.	-	-	- - 3,0	6 ad/pcs
150-1420-1420	Alüminyum Kapama Profili / Aluminium Closure Profile	Parlak / Bright	mt.	-	-	- - 3,0	10 ad/pcs

Multiline 4

50 KG SÜRME KAPAK SİSTEMİ • SLIDING DOOR SYSTEM

Yeni Ürün
New Product



Bilgi / Information

- 1 Kutu İçeriği : 2 Kapak Mekanizma + 4 Ad Yavaşlatıcı
- In 1 box : 2 Door Mechanism + 4 Pcs Soft Closers



Multiline 4 1 Set İçeriği / 1 Set Includes

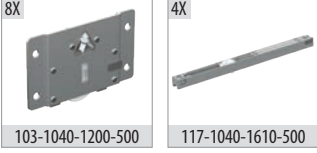

Ray Profilleri / Rail Profiles

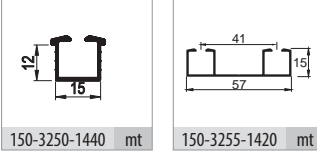

Kulp Profilleri / Handle Profiles

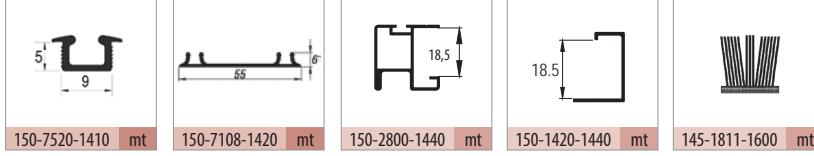

Teknik Detay / Technical Detail

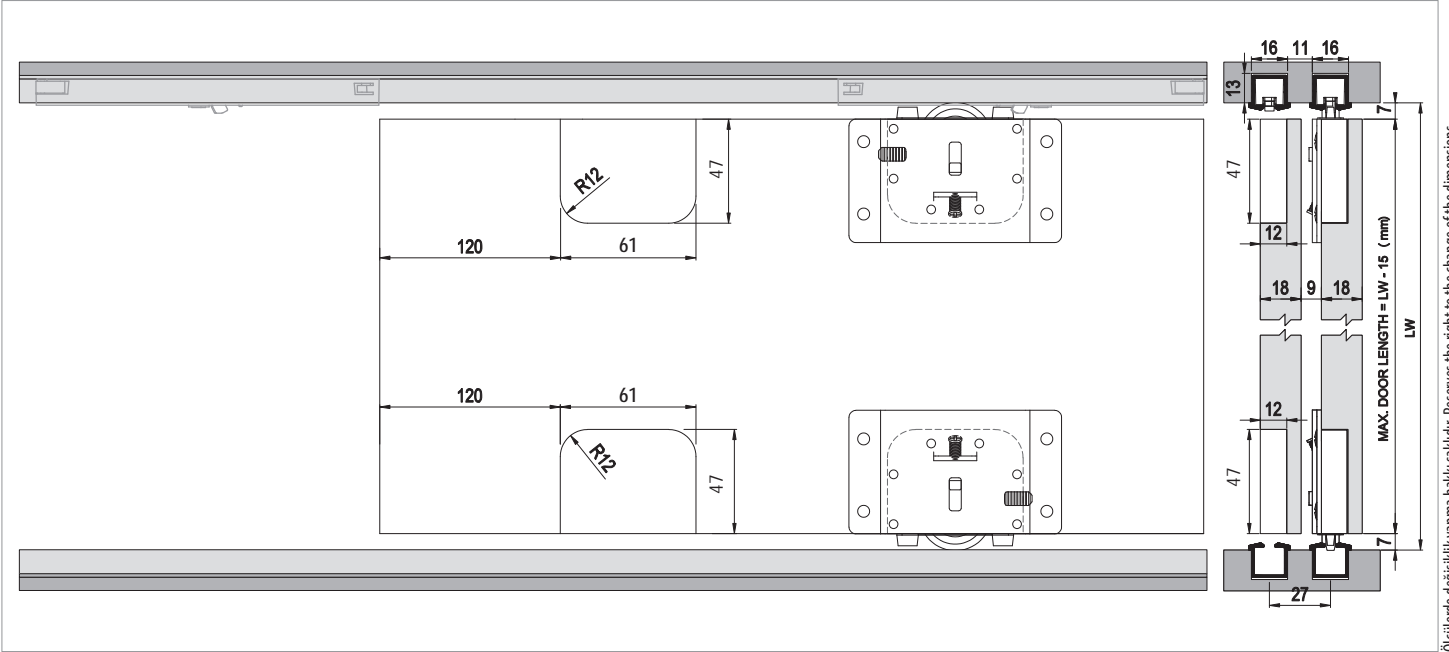

Ölçülerde değişiklik yapma hakkı saklıdır. Reserves the right to the change of the dimensions.

Kod / Code No	Açıklama / Description	Renk / Colour	Birim / Unit			Profil mt. / Profiles mt.	Bağ / Bnd.
103-1040-1200	Multiline 4 - Sürme Gardirop Sistemi / Sliding Wardrobe System	Silver	2 Kapak / 1 Set	12	360	-	-
145-1811-1600	Kıl Fital / Ec-Wf Hair Wick	Gri / Grey	mt.	300	7.200	-	-
150-3250-1440	Alüminyum Alt-Üst Ray Profili / Aluminium Bottom-Top Rail Profile	Bronz Parlak / Bronze Bright	mt.	-	-	-	3,0 4 ad/pcs
150-3255-1420	Alüminyum Üst Ray Profili / Aluminium Top Rail Profile	Parlak / Bright	mt.	-	-	-	3,0 12 ad/pcs
150-7108-1420	Alüminyum Alt Ray Profili / Aluminium Bottom Rail Profile	Parlak / Bright	mt.	-	-	-	3,0 12 ad/pcs
150-7520-1410	Alüminyum Alt Ray Profili / Aluminium Bottom Rail Profile	Eloksal / Mat Anodized	mt.	-	-	-	3,0 30 ad/pcs
150-2800-1440	Alüminyum Kulp Profili / Aluminium Handle Profile	Bronz Parlak / Bronze Bright	mt.	-	-	-	3,0 6 ad/pcs
150-1420-1440	Alüminyum Kapama Profili / Aluminium Closure Profile	Bronz Parlak / Bronze Bright	mt.	-	-	-	3,0 10 ad/pcs

Multiline 8

50 KG SÜRME KAPAK SİSTEMİ • SLIDING DOOR SYSTEM

Yeni Ürün
New Product



Bilgi / Information

- 1 Kutu İçeriği : 2 Kapak Mekanizma + 4 Ad Yavaşlatıcı
- In 1 box : 2 Door Mechanism + 4 Pcs Soft Closers



Multiline 8 1 Set İçeriği / 1 Set Includes

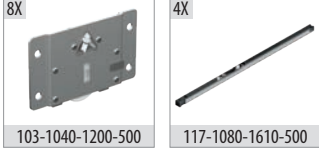

Ray Profilleri / Rail Profiles

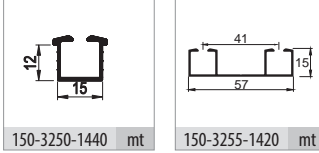

Kulp Profilleri / Handle Profiles

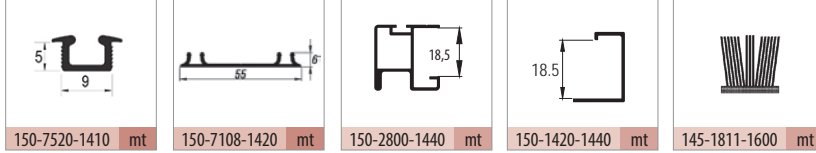

Teknik Detay / Technical Detail

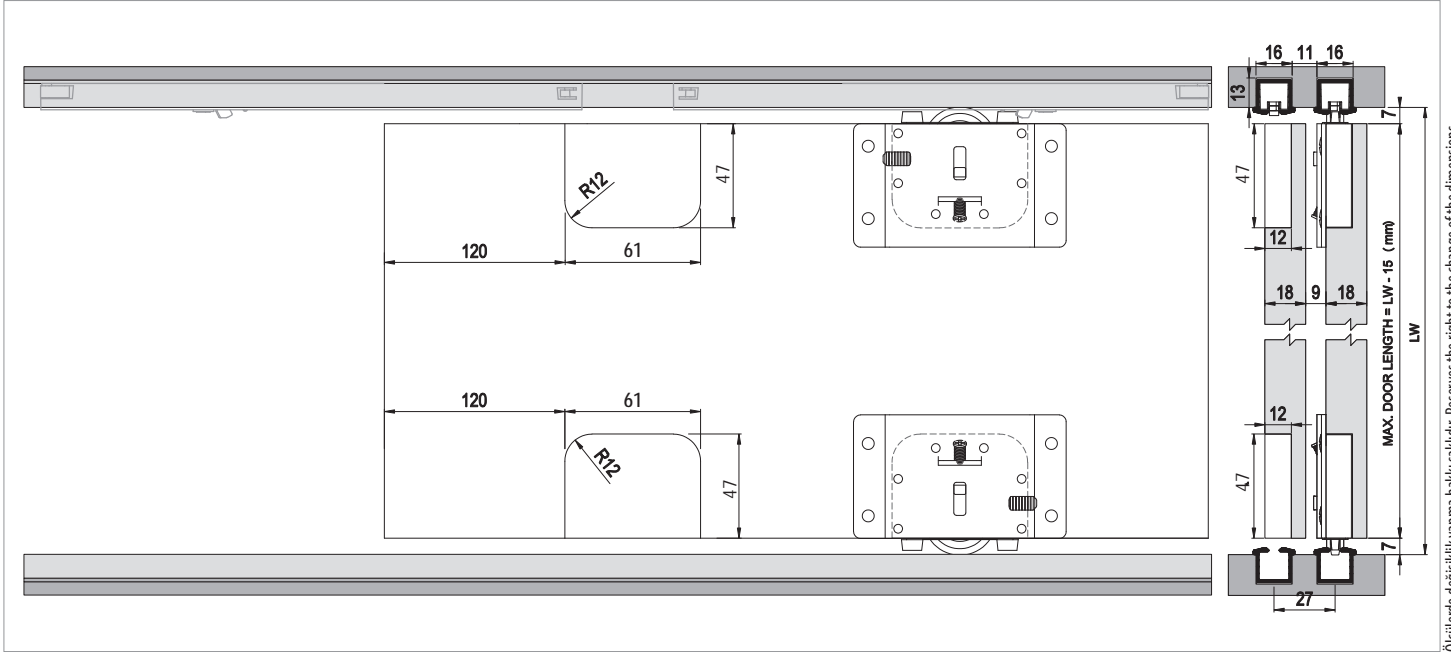

Ölçülerde değişiklik yapma hakkı saklıdır. Reserves the right to the change of the dimensions.

Kod / Code No	Açıklama / Description	Renk / Colour	Birim / Unit			Profil mt. / Profiles mt.	Bağ / Bnd.
103-1080-1200	Multiline 8 - Sürme Gardirop Sistemi / Sliding Wardrobe System	Silver	2 Kapak / 1 Set	12	360	-	-
145-1811-1600	Kıl Fital / Ec-Wf Hair Wick	Gri / Grey	mt.	300	7.200	-	-
150-3250-1440	Alüminyum Alt-Üst Ray Profili / Aluminium Bottom-Top Rail Profile	Bronz Parlak / Bronze Bright	mt.	-	-	3,0	4 ad/pcs
150-3255-1420	Alüminyum Üst Ray Profili / Aluminium Top Rail Profile	Parlak / Bright	mt.	-	-	3,0	12 ad/pcs
150-7108-1420	Alüminyum Alt Ray Profili / Aluminium Bottom Rail Profile	Parlak / Bright	mt.	-	-	3,0	12 ad/pcs
150-7520-1410	Alüminyum Alt Ray Profili / Aluminium Bottom Rail Profile	Eloksal / Mat Anodized	mt.	-	-	3,0	30 ad/pcs
150-2800-1440	Alüminyum Kulp Profili / Aluminium Handle Profile	Bronz Parlak / Bronze Bright	mt.	-	-	3,0	6 ad/pcs
150-1420-1440	Alüminyum Kapama Profili / Aluminium Closure Profile	Bronz Parlak / Bronze Bright	mt.	-	-	3,0	10 ad/pcs

Multiline 7

50 KG SÜRME KAPAK SİSTEMİ • SLIDING DOOR SYSTEM

Yeni Ürün
New Product



Bilgi / Information

- 1 Kutu İçeriği : 2 Kapak Yavaşlatıcılı Mekanizma
- In 1 box : 2 Door Mechanism with Soft Closers

Yavaşlatıcı Alternatifi / Soft Closer Alternative

- Sistem üzerinde entegre yavaşlatıcı mevcuttur.
- The system has integrated soft closer.



Multiline 7 1 Set İçeriği / 1 Set Includes

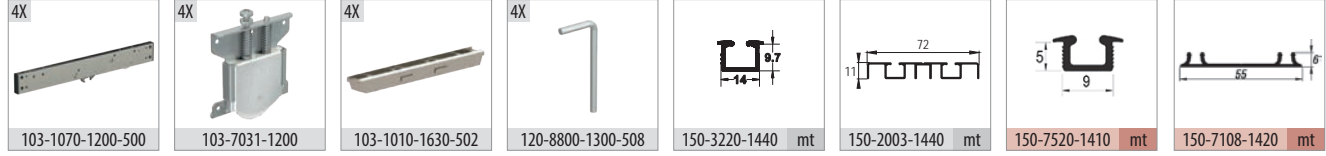

Kulp Profilleri / Handle Profiles

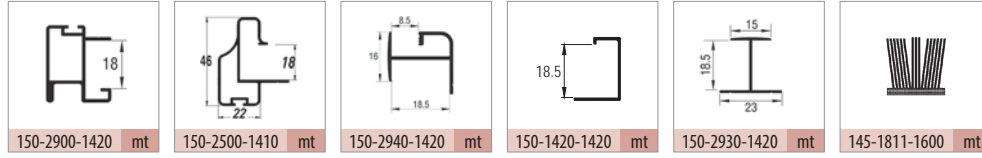

Teknik Detay / Technical Detail

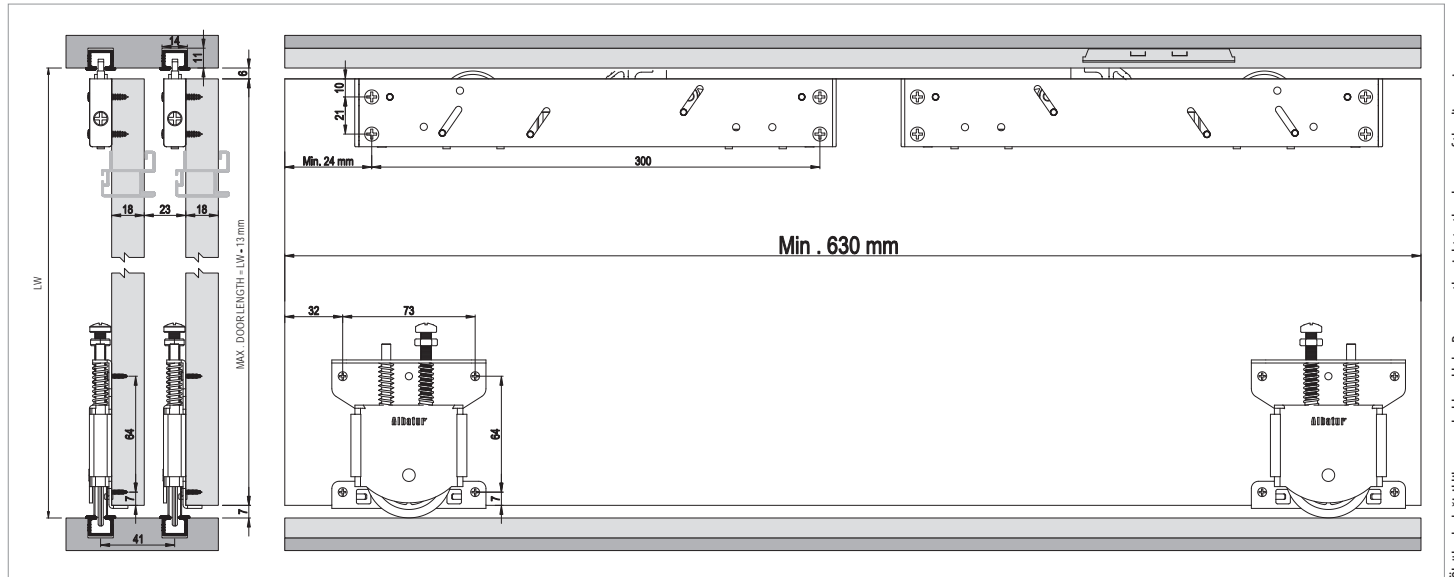

Ölçülerde değişiklik yapma hakkı saklıdır. Reserves the right to the change of the dimensions.

Kod / Code No	Açıklama / Description	Renk / Colour	Birim / Unit			Profil mt. / Profiles mt.	Bağ / Bnd.
103-1070-1200	Multiline 7 Sürme Gardrop Sistemi / Sliding Wardrobe System	Silver	2 Kapak / 1 Set	12	360	- - -	-
145-1811-1600	Kıl Fital / Ec-Wf Hair Wick	Gri / Grey	mt.	300	7.200	- - -	-
150-3220-1440	Alüminyum Alt-Üst Ray Profili / Aluminium Bottom-Top Rail Profile	Bronz Parlak / Bronze Bright	mt.	-	-	- - 3,0	20 ad/pcs
150-2003-1440	Alüminyum Alt-Üst Ray Profili / Aluminium Bottom-Top Rail Profile	Bronz Parlak / Bronze Bright	mt.	-	-	- - 3,0	12 ad/pcs
150-7108-1420	Alüminyum Alt Ray Profili / Aluminium Bottom Rail Profile	Parlak / Bright	mt.	-	-	- - 3,0	12 ad/pcs
150-7520-1410	Alüminyum Alt Ray Profili / Aluminium Bottom Rail Profile	Eloksal / Mat Anodized	mt.	-	-	- - 3,0	30 ad/pcs
150-2900-1420	Alüminyum Kulp Profili / Aluminium Handle Profile	Parlak / Bright	mt.	-	-	2,0 2,5 3,0	6 ad/pcs
150-2500-1410	Alüminyum Kulp Profili / Aluminium Handle Profile	Eloksal / Mat Anodized	mt.	-	-	- - 3,0	6 ad/pcs
150-2940-1420	Alüminyum Orta Kayıt / Aluminium Horizontal Central	Parlak / Bright	mt.	-	-	- - 3,0	10 ad/pcs
150-1420-1420	Alüminyum Kapama Profili / Aluminium Closure Profile	Parlak / Bright	mt.	-	-	- - 3,0	10 ad/pcs
150-2930-1420	Alüminyum Orta Kayıt / Aluminium Horizontal Central	Parlak / Bright	mt.	-	-	- - 3,0	10 ad/pcs

Multiline 9

45 KG SÜRME KAPAK SİSTEMİ • SLIDING DOOR SYSTEM

Yeni Ürün
New Product

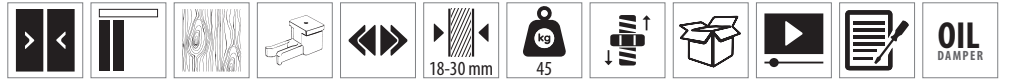

Yavaşlatıcı Alternatifi / Soft Closer Alternative

117-6959-1600 <<>>



103-1090-1300 1 Takım İçeriği / 1 Kit Includes

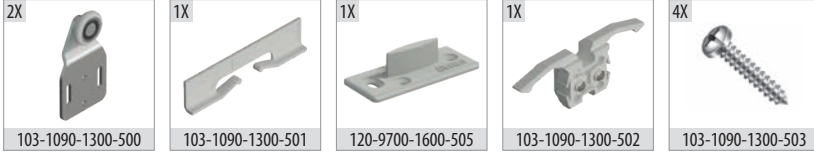

103-1091-1300 1 Takım İçeriği / 1 Kit Includes

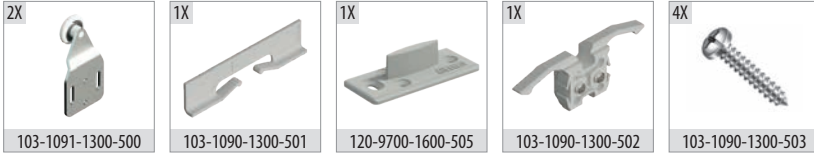

117-6959-1610 1 Takım İçeriği / 1 Kit Includes

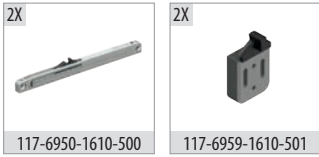

Ray Profilleri / Rail Profiles

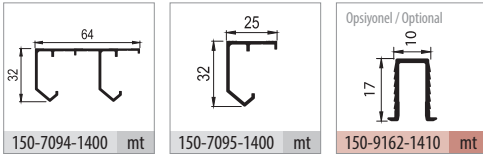

Teknik Detay / Technical Detail

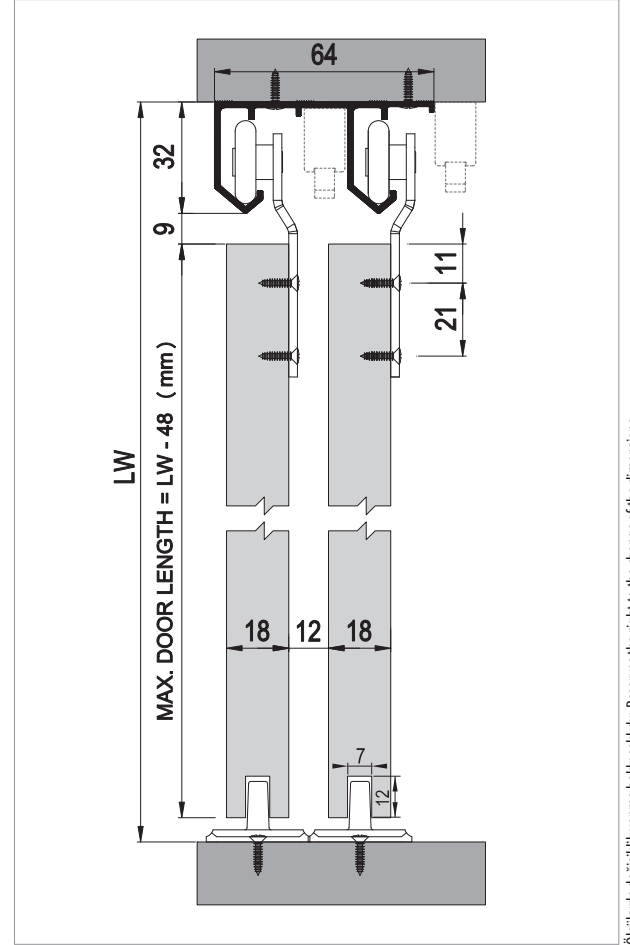

Ölçülerde değişiklik yapma hakkı saklıdır. Reserves the right to the change of the dimensions.

Kod / Code No	Açıklama / Description	Renk / Colour	Birim / Unit			Profil mt. / Profiles mt.	Bağ / Bnd.		
103-1090-1300	Multiline 9 - Sürme Kapak Sistemi / Sliding Door System	Galveniz / Galvanized	1 Kapak / 1 Kit	24	768	-	-	-	
103-1091-1300	Multiline 9 - Sürme Kapak Sistemi / Sliding Door System	Galveniz / Galvanized	1 Kapak / 1 Kit	24	768	-	-	-	
117-6959-1610	50 Kg Yavaşlatıcı Mekanizma / 50 Kg Soft Closer Mechanism	Gri / Grey	1 Takım / 1 Kit	50	1.250	-	-	-	
150-7094-1400	Alüminyum Üst Ray Profili / Aluminium Top Rail Profile	Pres / Uncoated	mt.	-	-	-	-	3,0	6 ad/pcs
150-7095-1400	Alüminyum Üst Ray Profili / Aluminium Top Rail Profile	Pres / Uncoated	mt.	-	-	-	-	3,0	6 ad/pcs
150-9162-1410	Alüminyum Alt Klavuz Profili / Aluminium Bottom Slider Profile	Eloksal / Mat Anodized	mt.	-	-	-	-	3,0	20 ad/pcs

Multiline 10

50 KG SÜRME KAPAK SİSTEMİ • SLIDING DOOR SYSTEM

Yeni Ürün
New Product



Bilgi / Information

- 1 Kutu İçeriği : 2 Kapak Mekanizma + 4 Ad Yavaşlatıcı
- In 1 box : 2 Door Mechanism + 4 Pcs Soft Closers



Multiline 10 1 Set İçeriği / 1 Set Includes

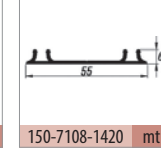
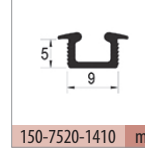
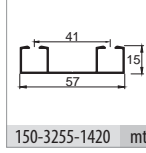
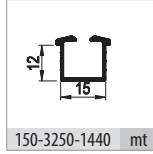
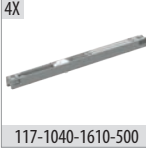
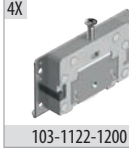
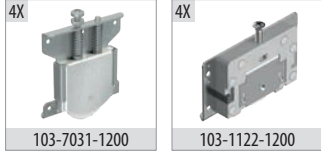

Ray Profilleri / Rail Profiles

Kulp Profilleri / Handle Profiles

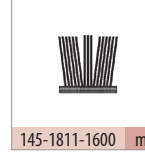
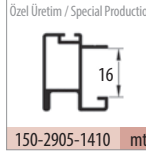
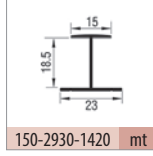
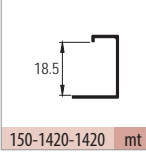
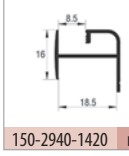
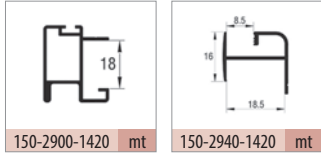

Teknik Detay / Technical Detail

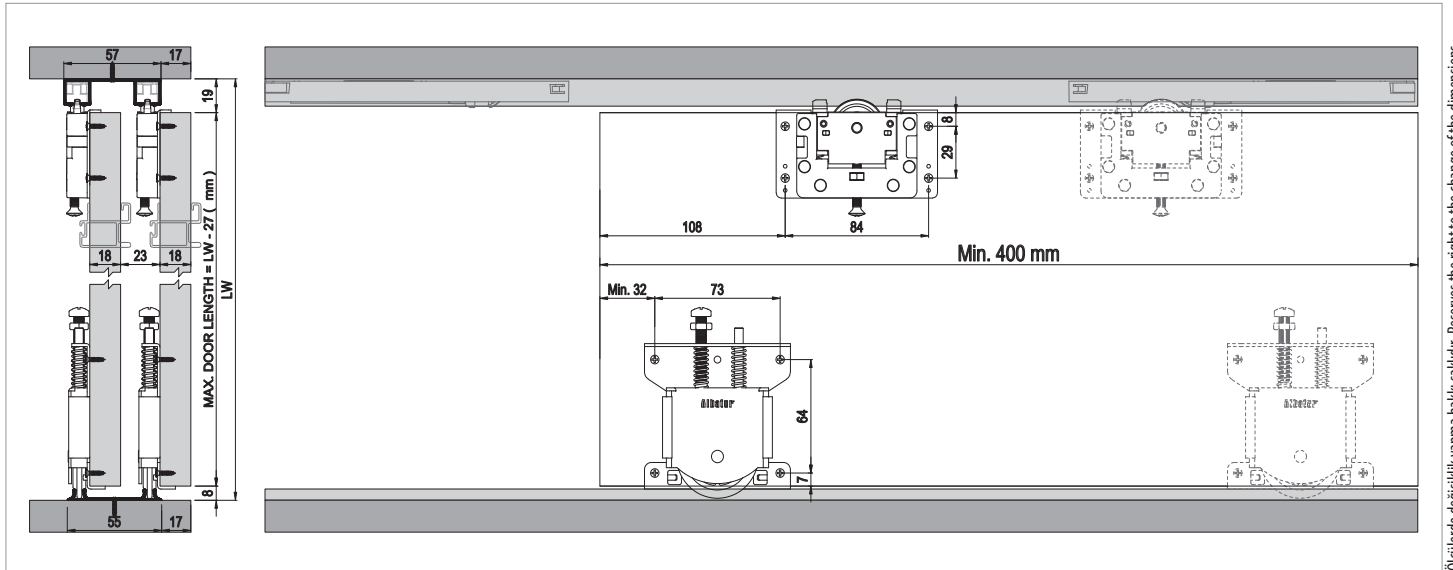

Ölçülerde değişiklik yapma hakkı saklıdır. Reserves the right to the change of the dimensions.

Kod / Code No	Açıklama / Description	Renk / Colour	Birim / Unit			Profil mt. / Profiles mt.			Bağ / Bnd.
103-1100-1200	Multiline 10 - Sürme Gardirop Sistemi / Sliding Wardrobe System	Silver	2 Kapak / 1 Set	12	360	-	-	-	-
145-1811-1600	Kıl Fital / Ec-Wf Hair Wick	Gri / Grey	mt.	300	7.200	-	-	-	-
150-3250-1440	Alüminyum Alt-Üst Ray Profili / Aluminium Bottom-Top Rail Profile	Bronz Parlak / Bronze Bright	mt.	-	-	-	-	3,0	4 ad/pcs
150-3255-1420	Alüminyum Üst Ray Profili / Aluminium Top Rail Profile	Parlak / Bright	mt.	-	-	-	-	3,0	12 ad/pcs
150-7108-1420	Alüminyum Alt Ray Profili / Aluminium Bottom Rail Profile	Parlak / Bright	mt.	-	-	-	-	3,0	12 ad/pcs
150-7520-1410	Alüminyum Alt Ray Profili / Aluminium Bottom Rail Profile	Eloksal / Mat Anodized	mt.	-	-	-	-	3,0	30 ad/pcs
150-2900-1420	Alüminyum Kulp Profili / Aluminium Handle Profile	Parlak / Bright	mt.	-	-	2,0	2,5	3,0	6 ad/pcs
150-2940-1420	Alüminyum Orta Kayıt / Aluminium Horizontal Central	Parlak / Bright	mt.	-	-	-	-	3,0	10 ad/pcs
150-1420-1420	Alüminyum Kapama Profili / Aluminium Closure Profile	Parlak / Bright	mt.	-	-	-	-	3,0	10 ad/pcs
150-2930-1420	Alüminyum Orta Kayıt / Aluminium Horizontal Central	Parlak / Bright	mt.	-	-	-	-	3,0	10 ad/pcs
150-2905-1410	Alüminyum Kulp Profili / Aluminium Handle Profile	Eloksal / Mat Anodized	mt.	-	-	-	-	3,0	6 ad/pcs

Multiline 11

50 KG SÜRME KAPAK SİSTEMİ • SLIDING DOOR SYSTEM

Yeni Ürün
New Product

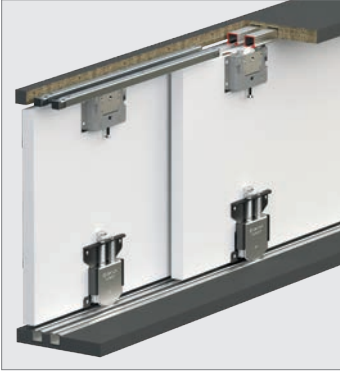

Bilgi / Information

- 1 Kutu İçeriği : 2 Kapak Mekanizma + 4 Ad Yavaşlatıcı
- In 1 box : 2 Door Mechanism + 4 Pcs Soft Closers



Multiline 11 1 Set İçeriği / 1 Set Includes

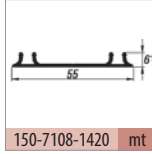
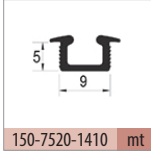
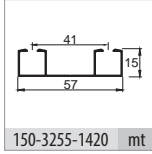
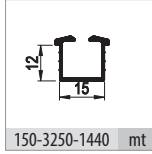
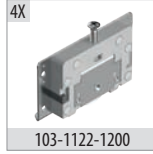
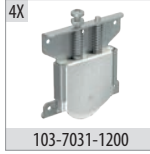

Kulp Profilleri / Handle Profiles

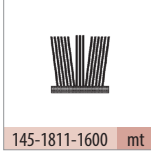
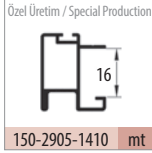
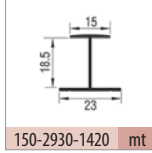
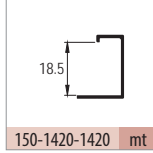
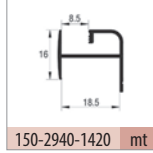
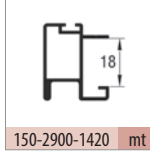

Teknik Detay / Technical Detail

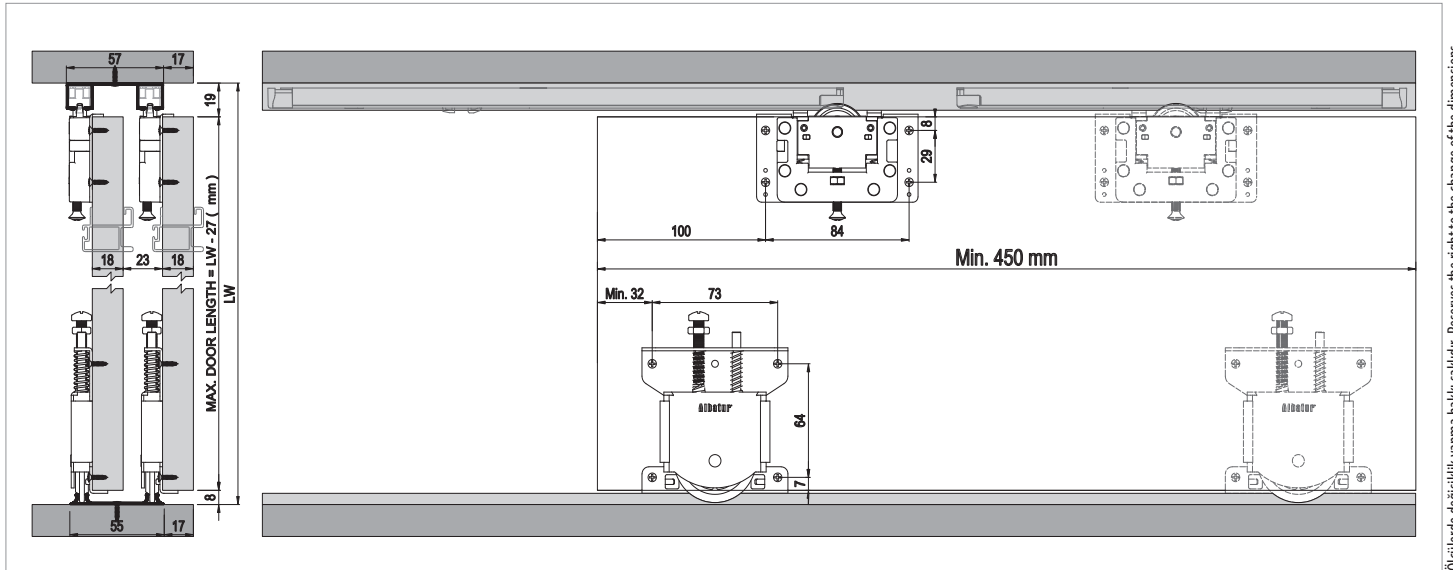

Ölçülerde değişiklik yapma hakkı saklıdır. Reserves the right to the change of the dimensions.

Kod / Code No	Açıklama / Description	Renk / Colour	Birim / Unit			Profil mt. / Profiles mt.	Bağ / Bnd.
103-1110-1200	Multiline 11 - Sürme Gardirop Sistemi / Sliding Wardrobe System	Silver	2 Kapak / 1 Set	12	360	- - -	-
145-1811-1600	Kıl Fital / Ec-Wf Hair Wick	Gri / Grey	mt.	300	7.200	- - -	-
150-3250-1440	Alüminyum Alt-Üst Ray Profili / Aluminium Bottom-Top Rail Profile	Bronz Parlak / Bronze Bright	mt.	-	-	- - 3,0	4 ad/pcs
150-3255-1420	Alüminyum Üst Ray Profili / Aluminium Top Rail Profile	Parlak / Bright	mt.	-	-	- - 3,0	12 ad/pcs
150-7108-1420	Alüminyum Alt Ray Profili / Aluminium Bottom Rail Profile	Parlak / Bright	mt.	-	-	- - 3,0	12 ad/pcs
150-7520-1410	Alüminyum Alt Ray Profili / Aluminium Bottom Rail Profile	Eloksal / Mat Anodized	mt.	-	-	- - 3,0	30 ad/pcs
150-2900-1420	Alüminyum Kulp Profili / Aluminium Handle Profile	Parlak / Bright	mt.	-	-	2,0 2,5 3,0	6 ad/pcs
150-2940-1420	Alüminyum Orta Kayıt / Aluminium Horizontal Central	Parlak / Bright	mt.	-	-	- - 3,0	10 ad/pcs
150-1420-1420	Alüminyum Kapama Profili / Aluminium Closure Profile	Parlak / Bright	mt.	-	-	- - 3,0	10 ad/pcs
150-2930-1420	Alüminyum Orta Kayıt / Aluminium Horizontal Central	Parlak / Bright	mt.	-	-	- - 3,0	10 ad/pcs
150-2905-1410	Alüminyum Kulp Profili / Aluminium Handle Profile	Eloksal / Mat Anodized	mt.	-	-	- - 3,0	6 ad/pcs

Multiline 12

50 KG SÜRME KAPAK SİSTEMİ • SLIDING DOOR SYSTEM

Yeni Ürün
New Product



Bilgi / Information

- 1 Kutu İçeriği : 2 Kapak Mekanizma + 4 Ad Yavaşlatıcı
- In 1 box : 2 Door Mechanism + 4 Pcs Soft Closers



Multiline 12 1 Set İçeriği / 1 Set Includes

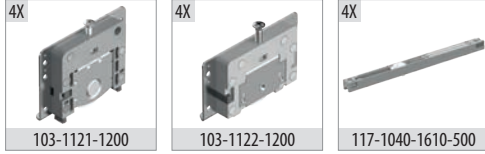

Ray Profilleri / Rail Profiles

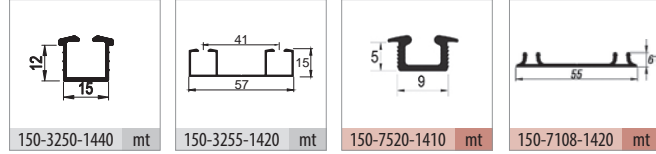

Kulp Profilleri / Handle Profiles

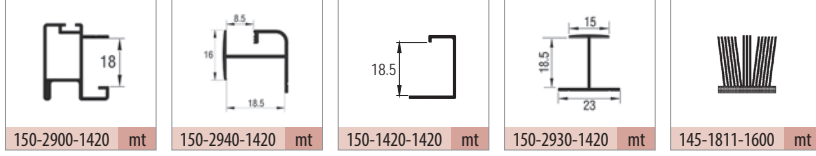

Teknik Detay / Technical Detail

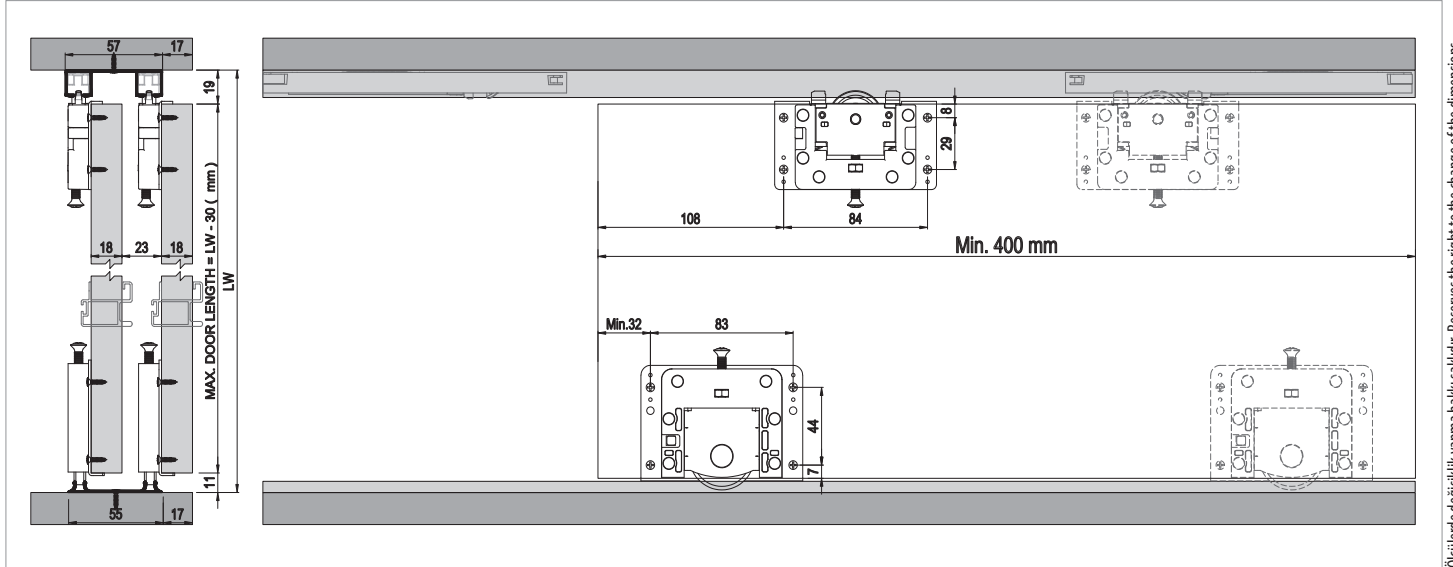

Ölçülerde değişiklik yapma hakkı saklıdır. Reserves the right to the change of the dimensions.

Kod / Code No	Açıklama / Description	Renk / Colour	Birim / Unit			Profil mt. / Profiles mt.			Bağ / Bnd.
103-1120-1200	Multiline 12 - Sürme Gardrop Sistemi / Sliding Wardrobe System	Silver	2 Kapak / 1 Set	12	360	-	-	-	-
145-1811-1600	Kıl Fital / Ec-Wf Hair Wick	Gri / Grey	mt.	300	7.200	-	-	-	-
150-3250-1440	Alüminyum Alt-Üst Ray Profili / Aluminium Bottom-Top Rail Profile	Bronz Parlak / Bronze Bright	mt.	-	-	-	-	3,0	4 ad/pcs
150-3255-1420	Alüminyum Üst Ray Profili / Aluminium Top Rail Profile	Parlak / Bright	mt.	-	-	-	-	3,0	12 ad/pcs
150-7108-1420	Alüminyum Alt Ray Profili / Aluminium Bottom Rail Profile	Parlak / Bright	mt.	-	-	-	-	3,0	12 ad/pcs
150-7520-1410	Alüminyum Alt Ray Profili / Aluminium Bottom Rail Profile	Eloksal / Mat Anodized	mt.	-	-	-	-	3,0	30 ad/pcs
150-2900-1420	Alüminyum Kulp Profili / Aluminium Handle Profile	Parlak / Bright	mt.	-	-	2,0	2,5	3,0	6 ad/pcs
150-2940-1420	Alüminyum Orta Kayıt / Aluminium Horizontal Central	Parlak / Bright	mt.	-	-	-	-	3,0	10 ad/pcs
150-1420-1420	Alüminyum Kapama Profili / Aluminium Closure Profile	Parlak / Bright	mt.	-	-	-	-	3,0	10 ad/pcs
150-2930-1420	Alüminyum Orta Kayıt / Aluminium Horizontal Central	Parlak / Bright	mt.	-	-	-	-	3,0	10 ad/pcs

Multiline 13

50 KG SÜRME KAPAK SİSTEMİ • SLIDING DOOR SYSTEM

Yeni Ürün
New Product



Bilgi / Information

- 1 Kutu İçeriği : 2 Kapak Mekanizma + 4 Ad Yavaşlatıcı
- In 1 box : 2 Door Mechanism + 4 Pcs Soft Closers



Multiline 13 1 Set İçeriği / 1 Set Includes

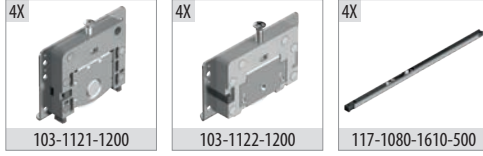

Ray Profilleri / Rail Profiles

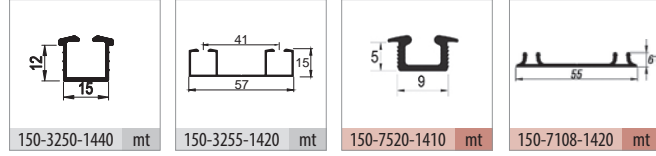

Kulp Profilleri / Handle Profiles

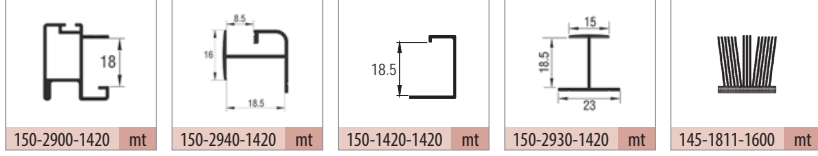

Teknik Detay / Technical Detail

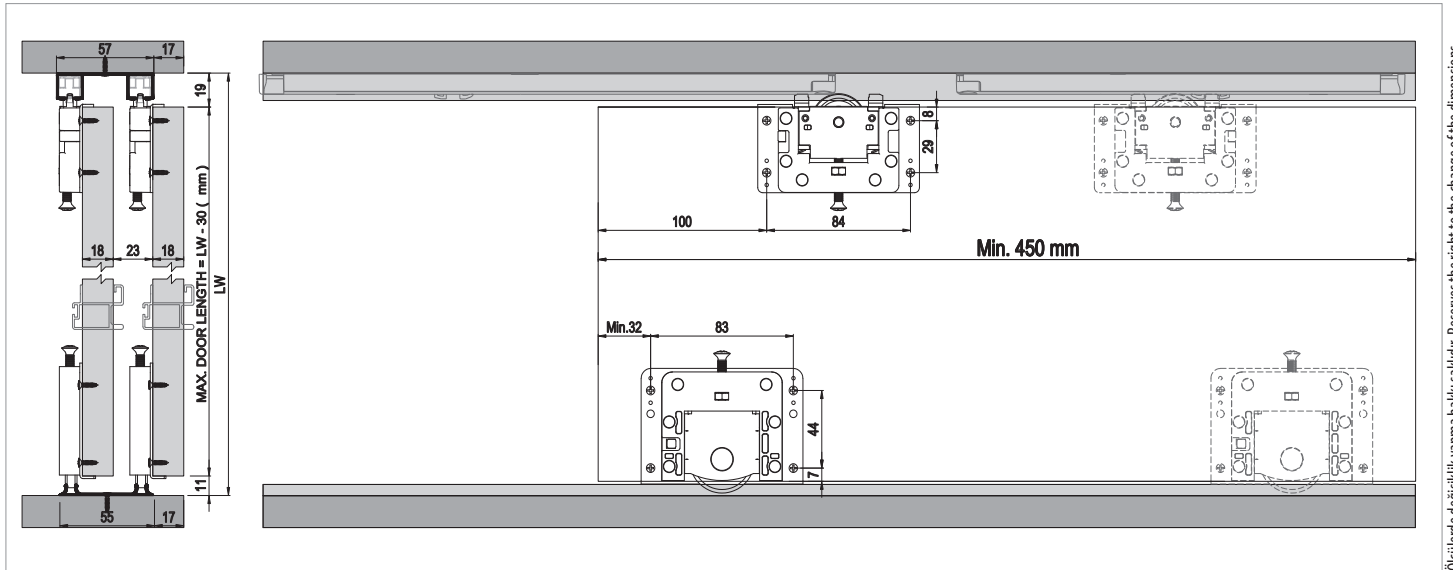

Ölçülerde değişiklik yapma hakkı saklıdır. Reserves the right to the change of the dimensions.

Kod / Code No	Açıklama / Description	Renk / Colour	Birim / Unit			Profil mt. / Profiles mt.	Bağ / Bnd.
103-1130-1200	Multiline 13 - Sürme Gardrop Sistemi / Sliding Wardrobe System	Silver	2 Kapak / 1 Set	12	360	-	-
145-1811-1600	Kıl Fital / Ec-Wf Hair Wick	Gri / Grey	mt.	300	7.200	-	-
150-3250-1440	Alüminyum Alt-Üst Ray Profili / Aluminium Bottom-Top Rail Profile	Bronz Parlak / Bronze Bright	mt.	-	-	-	3,0
150-3255-1420	Alüminyum Üst Ray Profili / Aluminium Top Rail Profile	Parlak / Bright	mt.	-	-	-	3,0
150-7108-1420	Alüminyum Alt Ray Profili / Aluminium Bottom Rail Profile	Parlak / Bright	mt.	-	-	-	3,0
150-7520-1410	Alüminyum Alt Ray Profili / Aluminium Bottom Rail Profile	Eloksal / Mat Anodized	mt.	-	-	-	3,0
150-2900-1420	Alüminyum Kulp Profili / Aluminium Handle Profile	Parlak / Bright	mt.	-	-	2,0	2,5
150-2940-1420	Alüminyum Orta Kayıt / Aluminium Horizontal Central	Parlak / Bright	mt.	-	-	-	3,0
150-1420-1420	Alüminyum Kapama Profili / Aluminium Closure Profile	Parlak / Bright	mt.	-	-	-	3,0
150-2930-1420	Alüminyum Orta Kayıt / Aluminium Horizontal Central	Parlak / Bright	mt.	-	-	-	3,0

Multiline 14

15 KG SÜRME KAPAK SİSTEMİ • SLIDING DOOR SYSTEM

Yeni Ürün
New Product

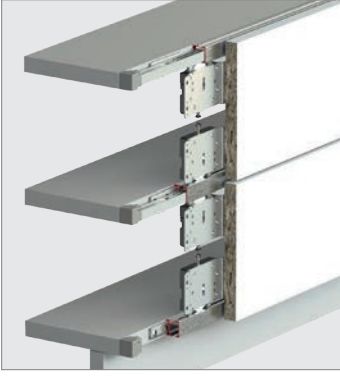

Bilgi / Information

- 1 Kutu İçeriği : 1 Kapak Mekanizma + 2 Ad Yavaşlatıcı
- In 1 box : 1 Door Mechanism + 2 Pcs Soft Closers



Multiline 14 1 Takım İçeriği / 1 Kit Includes

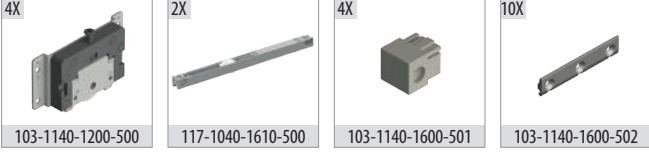

Ray Profilleri / Rail Profiles

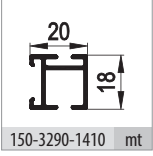

Teknik Detay / Technical Detail

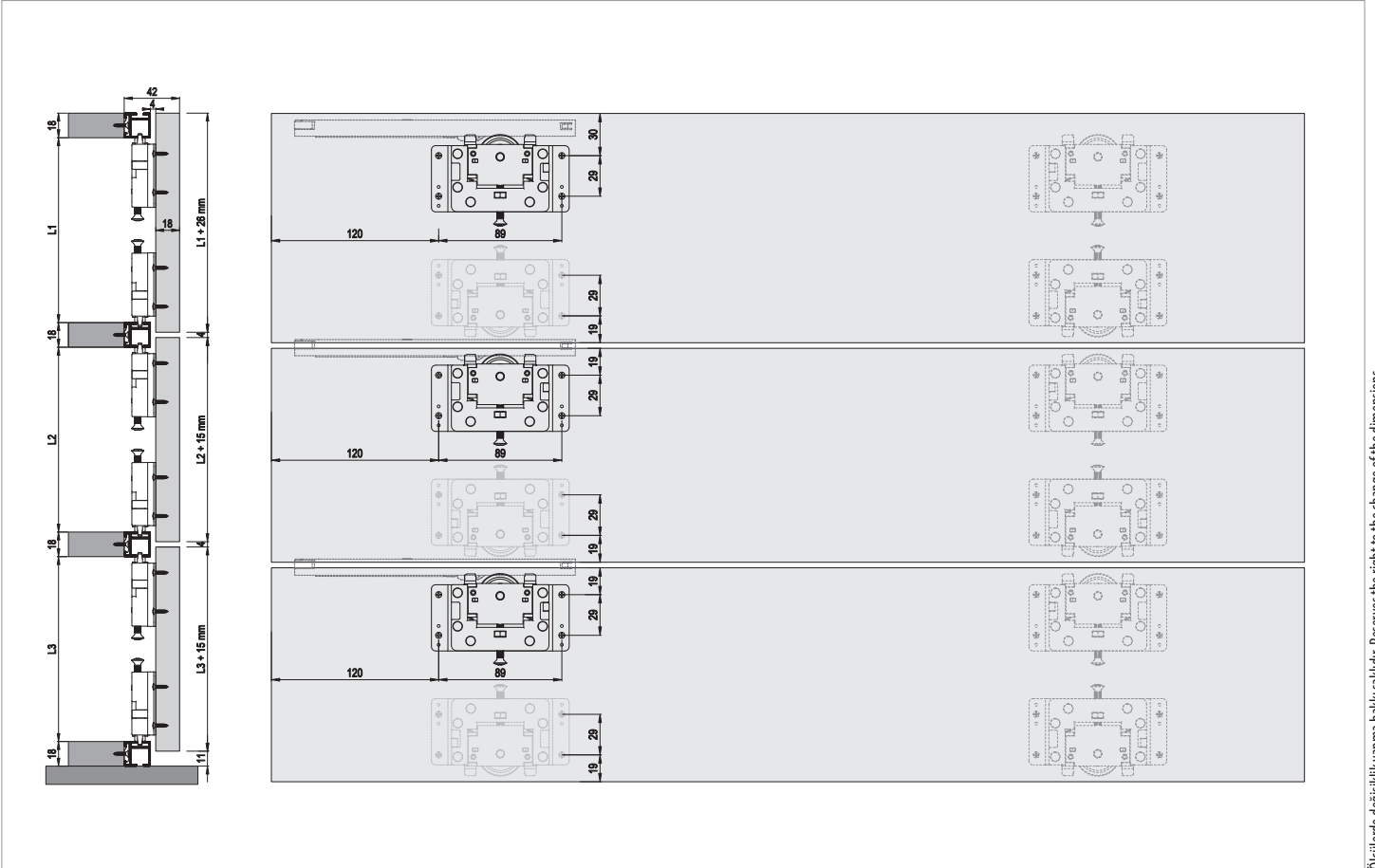

Ölçülerde değişiklik yapma hakkı saklıdır. Reserves the right to the change of the dimensions.

Kod / Code No	Açıklama / Description	Renk / Colour	Birim / Unit			Profil mt. / Profiles mt.	Bağ / Bnd.
103-1140-1200	Multiline 14 - Sürme Gardırop Sistemi / Sliding Wardrobe System	Silver	1 Kapak / 1 Kit	12	360	- - -	-
150-3290-1410	Alüminyum Alt-Üst Ray Profili / Aluminium Bottom-Top Rail Profile	Eloksal / Mat Anodized	mt.	-	-	- - 3,0	6 ad/pcs

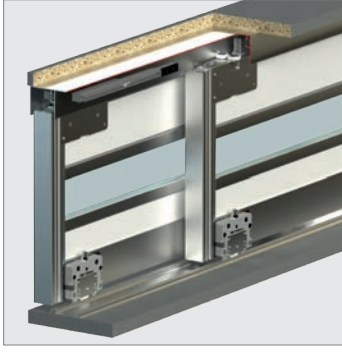

Bilgi / Information

- 1 Kutu İçeriği : 2 Kapak Mekanizma + 4 Ad Yavaşlatıcı
- In 1 box : 2 Door Mechanism + 4 Pcs Soft Closers

- 3 Kapaklı Dolap Uygulaması
- 3 Door Wardrobe Application

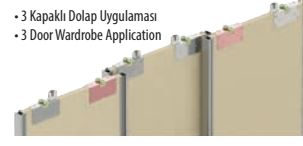

103-1150-1200 1 Set İçeriği / 1 Set Includes

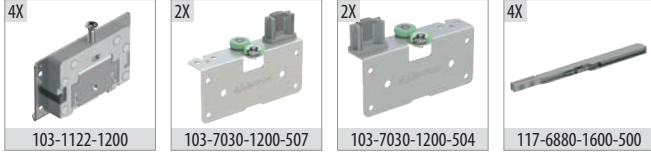

103-1151-1200 Opsiyonel 3. İç Kapak / Optional 3. Internal Door

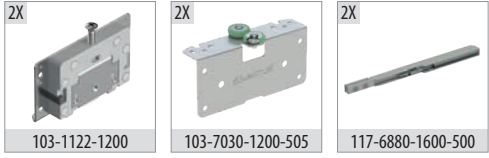

Ray Profilleri / Rail Profiles

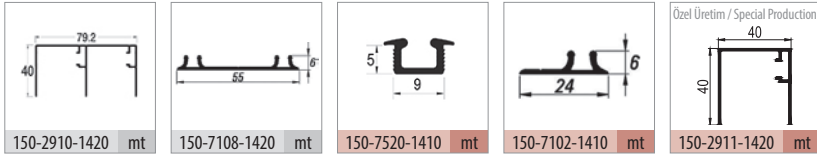

Kulp Profilleri / Handle Profiles

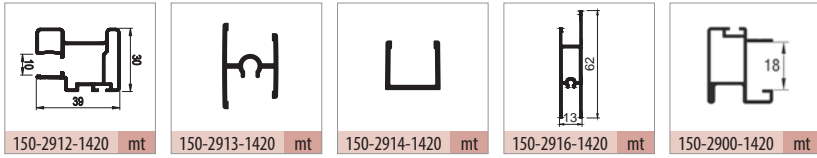

Opsiyonel Aksesuar / Optional Accessories

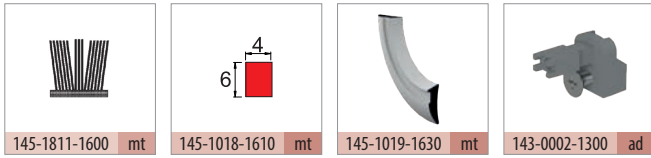

Teknik Detay / Technical Detail

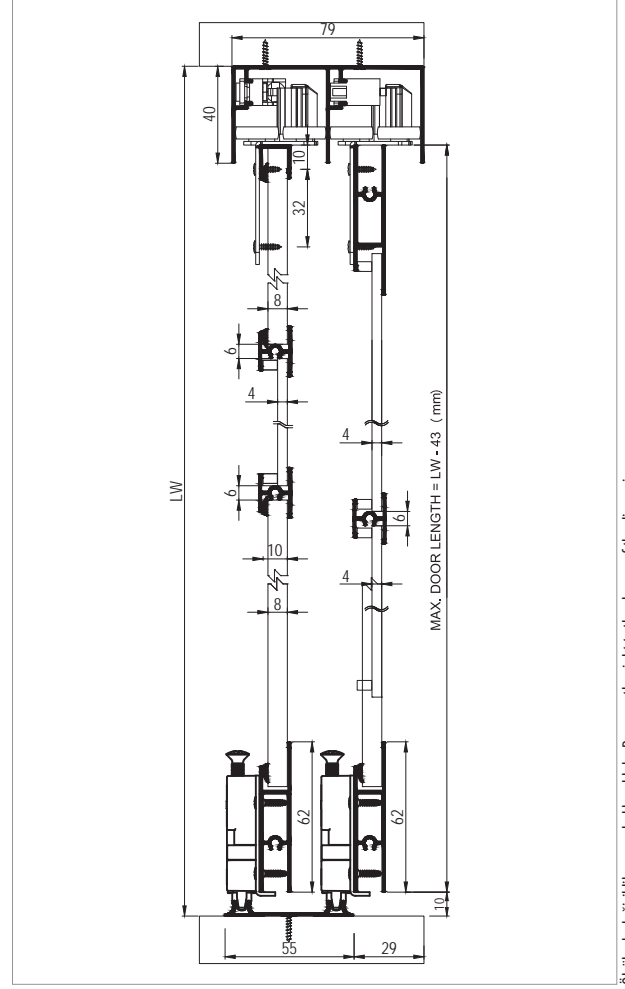

Ölçülerde değişiklik yapma hakkı saklıdır. Reserves the right to the change of the dimensions.

Kod / Code No	Açıklama / Description	Renk / Colour	Birim / Unit			Profil mt. / Profiles mt.	Bağ / Bnd.
103-1150-1200	Multiline 15 - Sürme Kapak Sistemi / Sliding Door System	Silver	2 Kapak / 1 Set	12	360	- - -	-
103-1151-1200	Multiline 15 - Sürme Kapak Sistemi 3. Kapak / Sliding Door System 3. Door	Silver	1 Kapak / 1 Kit	8	400	- - -	-
143-0002-1300	Bağlantı Kiti / Connection Kit	Silver	1 Adet / 1 Pcs	-	-	- - -	-
145-1018-1610	Cam Adaptör Fitolü / Glass Adapter Wick	Şeffaf / Transparan	mt.	100	3.600	- - -	-
145-1019-1630	8 mm Panel Adaptör Fitolü / 8 mm Panel Adapter Wick	Siyah / Black	mt.	100	3.600	- - -	-
145-1811-1600	Kıl Fitolü / Ec-Wf Hair Wick	Gri / Grey	mt.	300	7.200	- - -	-
150-2910-1420	Alüminyum Üst Ray Profili / Aluminium Top Rail Profile	Parlak / Bright	mt.	-	-	2,0 2,5 3,0	6 ad/pcs
150-7108-1420	Alüminyum Alt Ray Profili / Aluminium Bottom Rail Profile	Parlak / Bright	mt.	-	-	2,0 2,5 3,0	12 ad/pcs
150-2912-1420	Alüminyum Kulp Profili / Aluminium Handle Profile	Parlak / Bright	mt.	-	-	- - 3,0	4 ad/pcs
150-2913-1420	Alüminyum Orta Kayıt / Aluminium Horizontal Central	Parlak / Bright	mt.	-	-	- - 3,0	10 ad/pcs
150-2914-1420	Alüminyum Kapama Profili / Aluminium Closure Profile	Parlak / Bright	mt.	-	-	- - 3,0	24 ad/pcs
150-2916-1420	Alüminyum Çerçeve Profili / Aluminium Frame Profile	Parlak / Bright	mt.	-	-	- - 3,0	4 ad/pcs

Multiline SRG 100

60 KG SÜRME KAPAK SİSTEMİ • SLIDING DOOR SYSTEM

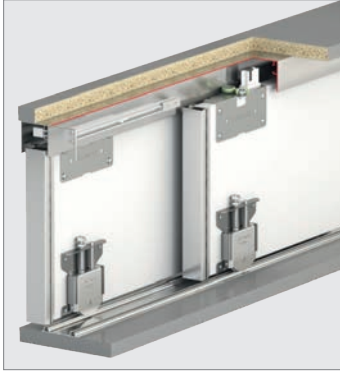

Bilgi / Information

- 1 Kutu İçeriği : 2 Kapak Mekanizma + 4 Ad Yavaşlatıcı
- In 1 box : 2 Door Mechanism + 4 Pcs Soft Closers

- 3 Kapaklı Dolap Uygulaması
- 3 Door Wardrobe Application



SRG 100 1 Set İçeriği / 1 Set Includes

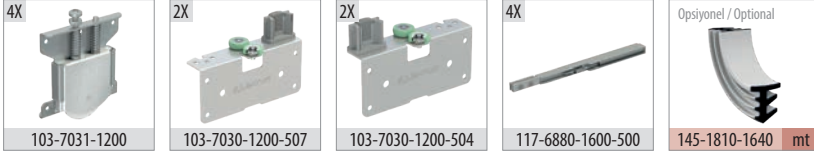

SRG 103 Opsiyonel 3. İç Kapak / Optional 3. Internal Door

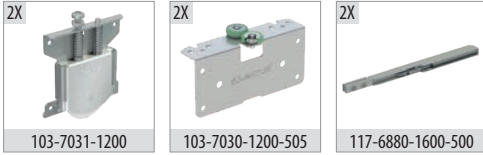

Ray Profilleri / Rail Profiles

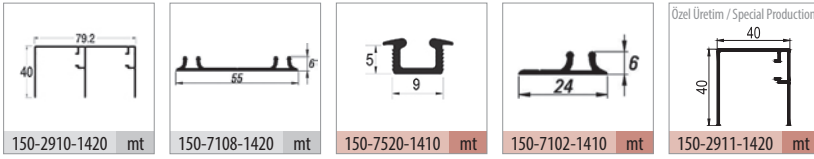

Kulp Profilleri / Handle Profiles

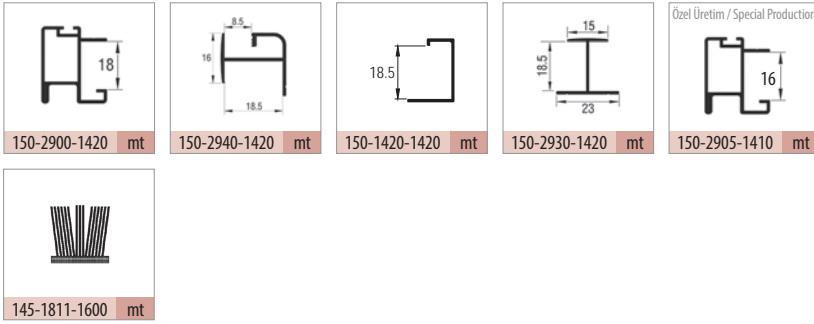

Teknik Detay / Technical Detail

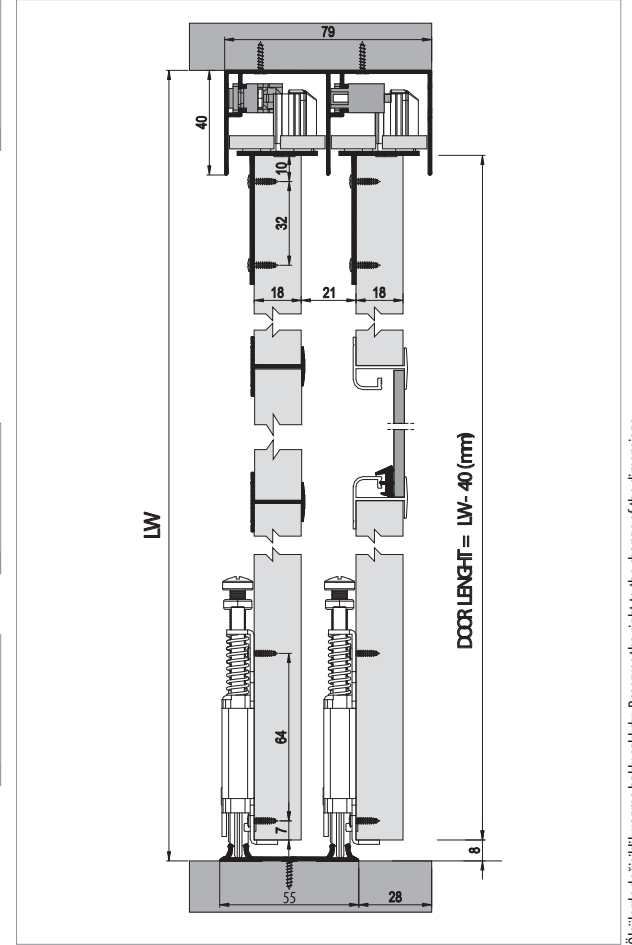

Ölçülerde değişiklik yapma hakkı saklıdır. Reserves the right to the change of the dimensions.

Kod / Code No	Açıklama / Description	Renk / Colour	Birim / Unit			Profil mt. / Profiles mt.	Bağ / Bnd.
103-0100-1200	SRG 100 - Sürme Kapak Sistemi / Sliding Door System	Silver	2 Kapak / 1 Set	12	360	- - -	-
103-0103-1200	SRG 100 C - Sürme Kapak Sistemi 3. Kapak / Sliding Wardrobe System 3. Door	Silver	1 Kapak / 1 Kit	8	400	- - -	-
145-1810-1640	Cam Fitolü / Glass Wick	Şeffaf / Transparan	mt.	100	3.600	- - -	-
150-2910-1420	Alüminyum Üst Ray Profili / Aluminium Top Rail Profile	Parlak / Bright	mt.	-	-	2,0 2,5 3,0	6 ad/pcs
150-7108-1420	Alüminyum Alt Ray Profili / Aluminium Bottom Rail Profile	Parlak / Bright	mt.	-	-	2,0 2,5 3,0	12 ad/pcs
150-2900-1420	Alüminyum Kulp Profili / Aluminium Handle Profile	Parlak / Bright	mt.	-	-	2,0 2,5 3,0	6 ad/pcs
150-2940-1420	Alüminyum Orta Kayıt / Aluminium Horizontal Central	Parlak / Bright	mt.	-	-	- - 3,0	10 ad/pcs
150-1420-1420	Alüminyum Kapama Profili / Aluminium Closure Profile	Parlak / Bright	mt.	-	-	- - 3,0	10 ad/pcs
150-2930-1420	Alüminyum Orta Kayıt / Aluminium Horizontal Central	Parlak / Bright	mt.	-	-	- - 3,0	10 ad/pcs

Multiline SRG 300

70 KG SÜRME KAPAK SİSTEMİ • SLIDING DOOR SYSTEM

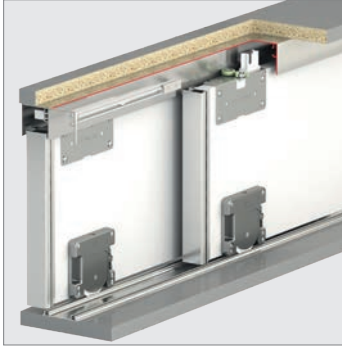

Bilgi / Information

- 1 Kutu İçeriği : 2 Kapak Mekanizma + 4 Ad Yavaşlatıcı
- In 1 box : 2 Door Mechanism + 4 Pcs Soft Closers



SRG 300 1 Set İçeriği / 1 Set Includes

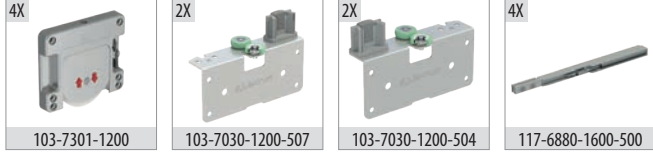

SRG 303 Opsiyonel 3. İç Kapak / Optional 3. Internal Door

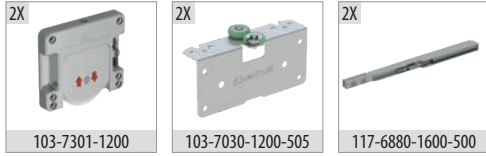

Ray Profilleri / Rail Profiles

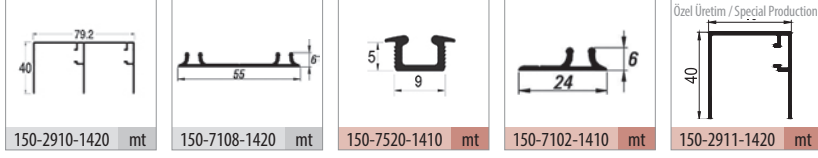

Kulp Profilleri / Handle Profiles

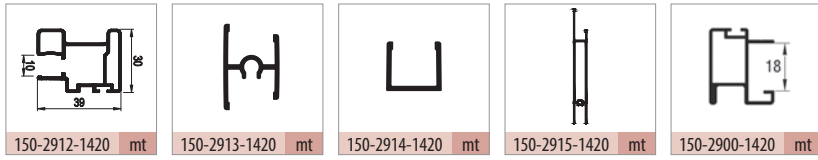

Opsiyonel Aksesuar / Optional Accessories

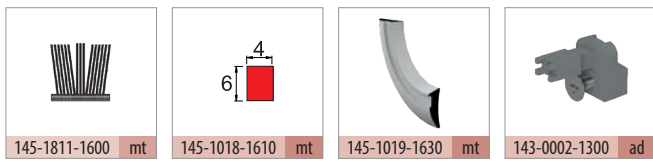

Teknik Detay / Technical Detail

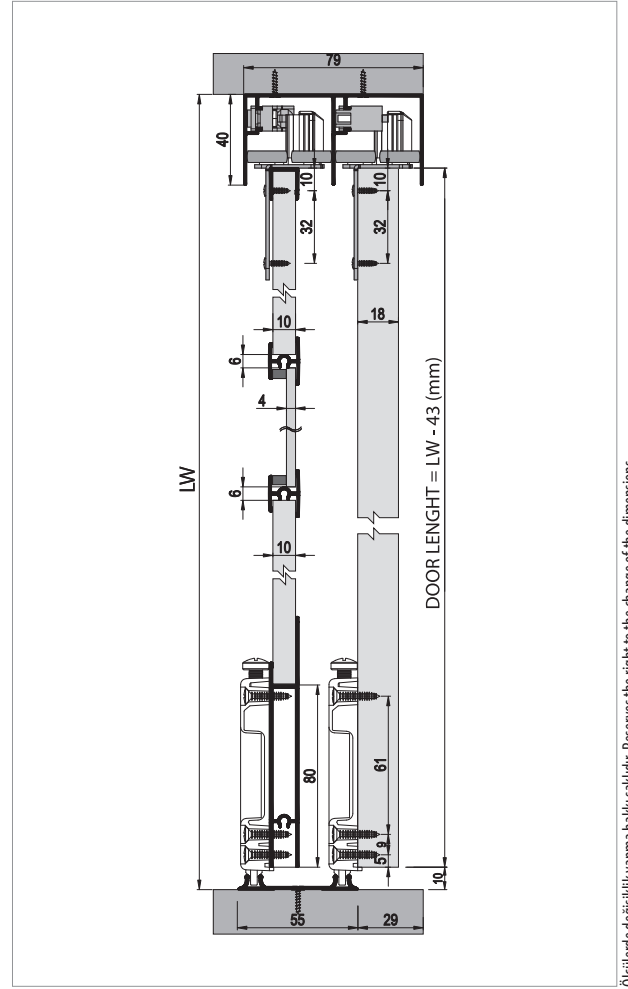

Ölçülerde değişiklik yapma hakkı saklıdır. Reserves the right to the change of the dimensions.

Kod / Code No	Açıklama / Description	Renk / Colour	Birim / Unit			Profil mt. / Profiles mt.	Bağ / Bnd.
103-0300-1200	SRG 300 - Sürme Kapak Sistemi / Sliding Door System	Silver	2 Kapak / 1 Set	12	360	- - -	-
103-0303-1200	SRG 300 C - Sürme Kapak Sistemi 3. Kapak / Sliding Door System 3. Door	Silver	1 Kapak / 1 Kit	8	400	- - -	-
143-0002-1300	Bağlantı Kiti / Connection Kit	Silver	1 Adet / 1 Pcs	-	-	- - -	-
145-1018-1610	Cam Adaptör Fitolü / Glass Adapter Wick	Şeffaf / Transparan	mt.	100	3.600	- - -	-
145-1019-1630	8 mm Panel Adaptör Fitolü / 8 mm Panel Adapter Wick	Siyah / Black	mt.	100	3.600	- - -	-
145-1811-1600	Kıl Fitolü / Ec-Wf Hair Wick	Gri / Grey	mt.	300	7.200	- - -	-
150-2910-1420	Alüminyum Üst Ray Profili / Aluminium Top Rail Profile	Parlak / Bright	mt.	-	-	2,0 2,5 3,0	6 ad/pcs
150-7108-1420	Alüminyum Alt Ray Profili / Aluminium Bottom Rail Profile	Parlak / Bright	mt.	-	-	2,0 2,5 3,0	12 ad/pcs
150-2912-1420	Alüminyum Kulp Profili / Aluminium Handle Profile	Parlak / Bright	mt.	-	-	2,0 - 3,0	4 ad/pcs
150-2913-1420	Alüminyum Orta Kayıt / Aluminium Horizontal Central	Parlak / Bright	mt.	-	-	- 3,0	10 ad/pcs
150-2914-1420	Alüminyum Kapama Profili / Aluminium Closure Profile	Parlak / Bright	mt.	-	-	- 3,0	24 ad/pcs
150-2915-1420	Alüminyum Çerçeve Profili / Aluminium Frame Profile	Parlak / Bright	mt.	-	-	- 3,0	4 ad/pcs

Multiline SRG 110

70 KG SÜRME KAPAK SİSTEMİ • SLIDING DOOR SYSTEM

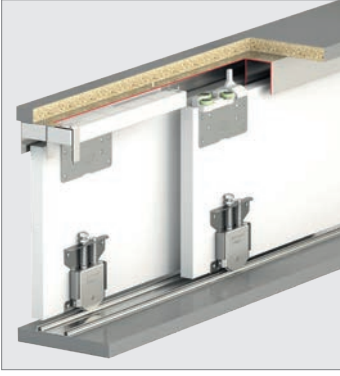

Bilgi / Information

- 1 Kutu İçeriği : 2 Kapak Mekanizma + 4 Ad Yavaşlatıcı
- In 1 box : 2 Door Mechanism + 4 Pcs Soft Closers

- 3 Kapaklı Dolap Uygulaması
- 3 Door Wardrobe Application

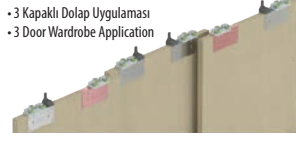

SRG 110 1 Set İçeriği / 1 Set Includes

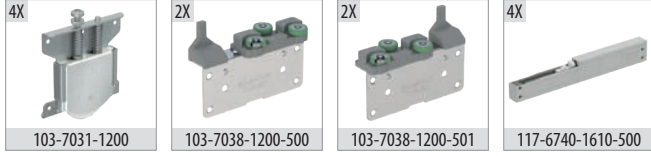

Ray Profilleri / Rail Profiles

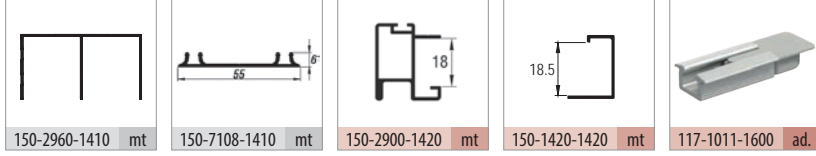

Kulp Profilleri / Handle Profiles



Teknik Detay / Technical Detail

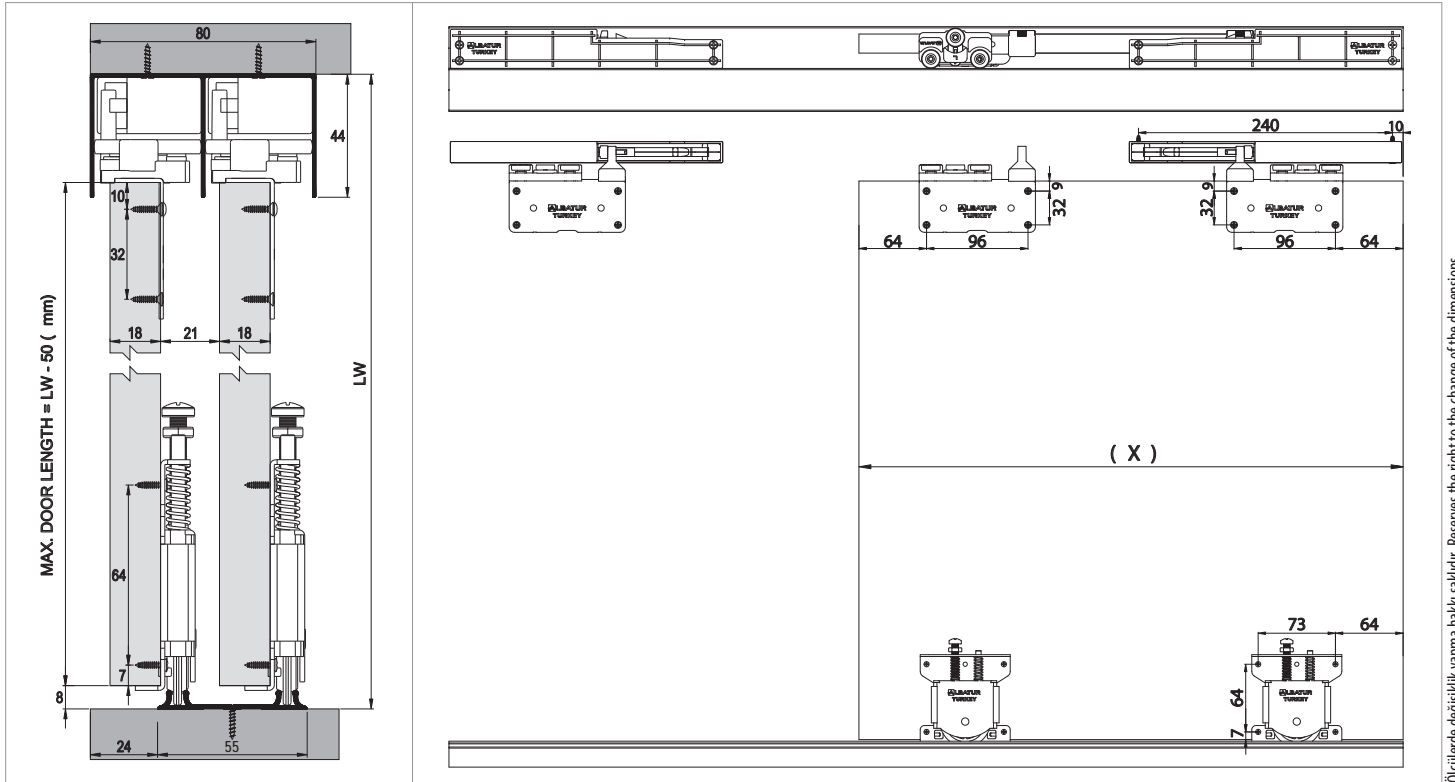

Ölçülerde değişiklik yapma hakkı saklıdır. Reserves the right to the change of the dimensions.

Kod / Code No	Açıklama / Description	Renk / Colour	Birim / Unit			Profil mt. / Profiles mt.	Bağ / Bnd.
103-0110-1200	SRG 110 - Sürme Kapak Sistemi / Sliding Door System	Silver	2 Kapak / 1 Set	12	216	- - -	-
117-1011-1600	Plastik Ray Tapası / Plastic Stopper	Gri / Grey	1 Adet / 1 Pcs	1.000	120.000	- - -	-
150-2960-1410	Alüminyum Üst Ray Profili / Aluminium Top Rail Profile	Eloksal / Mat Anodized	mt.	-	-	2,0 2,5 3,0	6 ad/pcs
150-7108-1410	Alüminyum Alt Ray Profili / Aluminium Bottom Rail Profile	Eloksal / Mat Anodized	mt.	-	-	2,0 2,5 3,0	12 ad/pcs
150-2900-1420	Alüminyum Kulp Profili / Aluminium Handle Profile	Parlak / Bright	mt.	-	-	2,0 2,5 3,0	6 ad/pcs
150-1420-1420	Alüminyum Kapama Profili / Aluminium Closure Profile	Parlak / Bright	mt.	-	-	- - 3,0	10 ad/pcs



albaturas.com

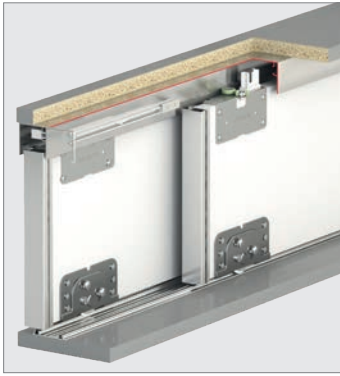

Bilgi / Information

- 1 Kutu İçeriği : 2 Kapak Mekanizma + 4 Ad Yavaşlatıcı
- In 1 box : 2 Door Mechanism + 4 Pcs Soft Closers

- 3 Kapaklı Dolap Uygulaması
- 3 Door Wardrobe Application



SRG 210 1 Set İçeriği / 1 Set Includes

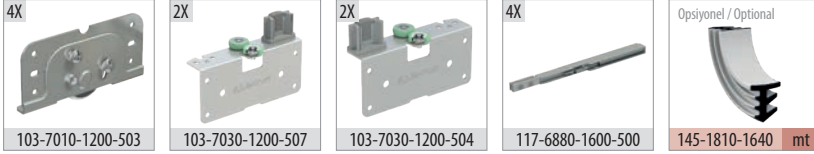

SRG 213 Opsiyonel 3. İç Kapak / Optional 3. Internal Door

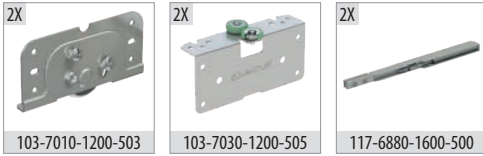

Ray Profilleri / Rail Profiles

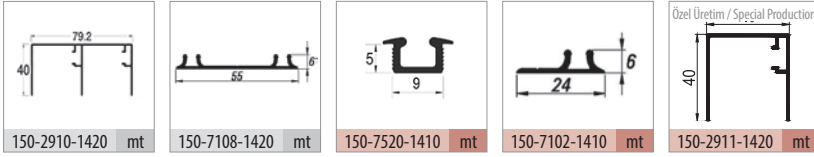

Kulp Profilleri / Handle Profiles

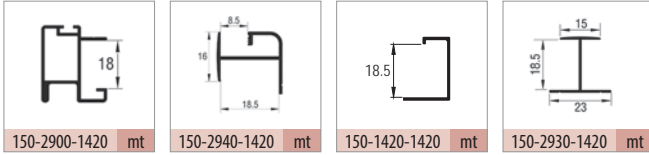

Opsiyonel Aksesuar / Optional Accessories

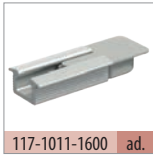

Teknik Detay / Technical Detail

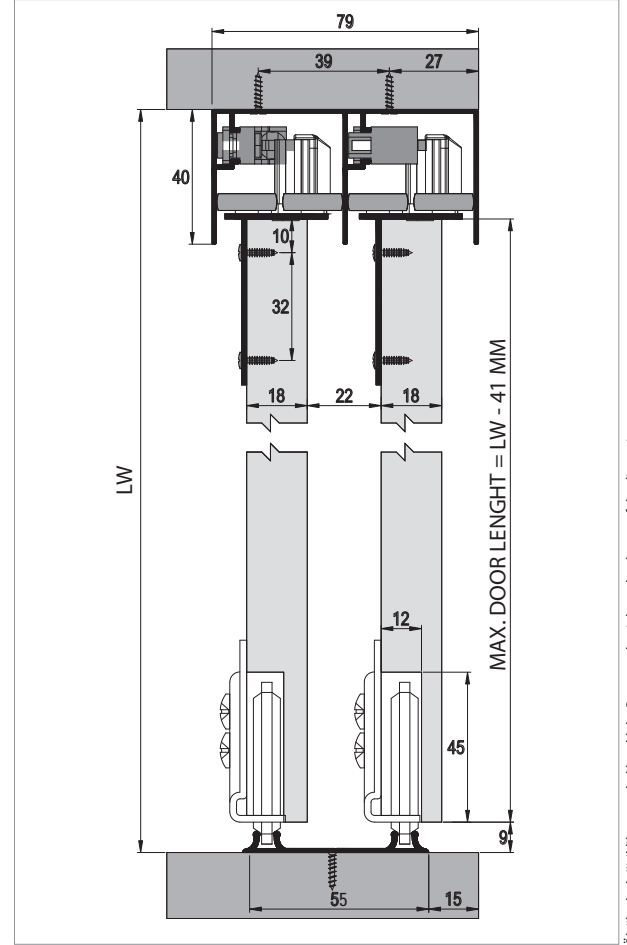

Ölçülerde değişiklik yapma hakkı saklıdır. Reserves the right to the change of the dimensions.

Kod / Code No	Açıklama / Description	Renk / Colour	Birim / Unit			Profil mt. / Profiles mt.	Bağ / Bnd.
103-0210-1200	SRG 210 - Sürme Kapak Sistemi / Sliding Door System	Silver	2 Kapak / 1 Set	12	360	- - -	-
103-0213-1200	SRG 210 C - Sürme Kapak Sistemi 3. Kapak / Sliding Door System 3. Door	Silver	1 Kapak / 1 Kit	12	360	- - -	-
145-1810-1640	Cam Fitolu / Glass Wick	Şeffaf / Transparan	mt.	100	3.600	- - -	-
150-2910-1420	Alüminyum Üst Ray Profili / Aluminium Top Rail Profile	Parlak / Bright	mt.	-	-	2,0 2,5 3,0	6 ad/pcs
150-7108-1420	Alüminyum Alt Ray Profili / Aluminium Bottom Rail Profile	Parlak / Bright	mt.	-	-	2,0 2,5 3,0	12 ad/pcs
150-2900-1420	Alüminyum Kulp Profili / Aluminium Handle Profile	Parlak / Bright	mt.	-	-	2,0 2,5 3,0	6 ad/pcs
150-2940-1420	Alüminyum Orta Kayıt / Aluminium Horizontal Central	Parlak / Bright	mt.	-	-	- - 3,0	10 ad/pcs
150-1420-1420	Alüminyum Kapama Profili / Aluminium Closure Profile	Parlak / Bright	mt.	-	-	- - 3,0	10 ad/pcs
150-2930-1420	Alüminyum Orta Kayıt / Aluminium Horizontal Central	Parlak / Bright	mt.	-	-	- - 3,0	10 ad/pcs

Multiline SRG 130

60 KG SÜRME KAPAK SİSTEMİ • SLIDING DOOR SYSTEM

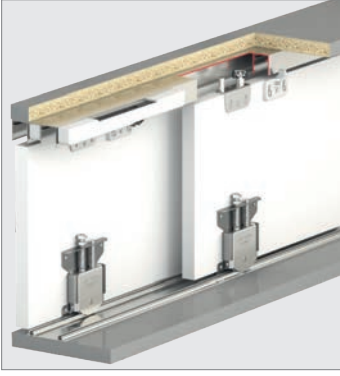

Bilgi / Information

- 1 Kutu İçeriği : 2 Kapak Mekanizma + 4 Ad Yavaşlatıcı
- In 1 box : 2 Door Mechanism + 4 Pcs Soft Closers



SRG 130 1 Set İçeriği / 1 Set Includes

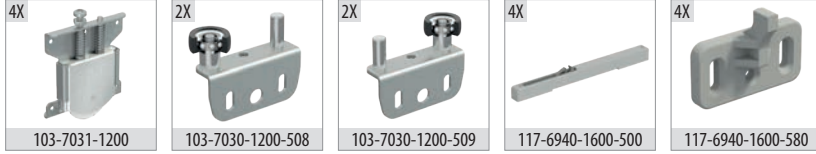

Ray Profilleri / Rail Profiles

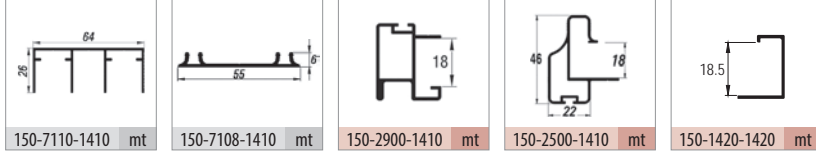

Kulp Profilleri / Handle Profiles

Teknik Detay / Technical Detail

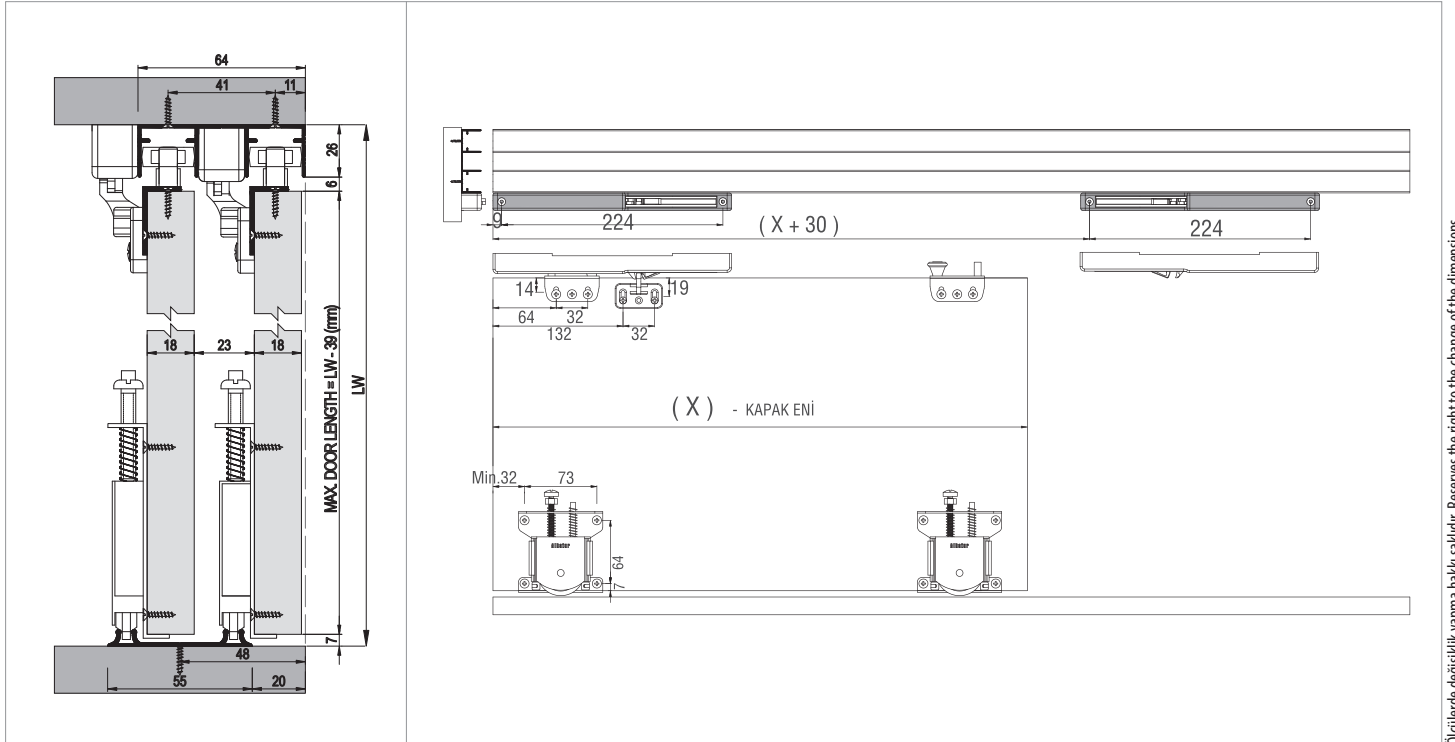

Ölçülerde değişiklik yapma hakkı saklıdır. Reserves the right to the change of the dimensions.

Kod / Code No	Açıklama / Description	Renk / Colour	Birim / Unit			Profil mt. / Profiles mt.			Bağ / Bnd.
103-0130-1200	SRG 130 - Sürme Kapak Sistemi / Sliding Door System	Silver	2 Kapak / 1 Set	12	360	-	-	-	-
150-7110-1410	Alüminyum Üst Ray Profili / Aluminium Top Rail Profile	Eloksal / Mat Anodized	mt.	-	-	2,0	2,5	3,0	6 ad/pcs
150-7108-1410	Alüminyum Alt Ray Profili / Aluminium Bottom Rail Profile	Eloksal / Mat Anodized	mt.	-	-	2,0	2,5	3,0	12 ad/pcs
150-2900-1410	Alüminyum Kulp Profili / Aluminium Handle Profile	Eloksal / Mat Anodized	mt.	-	-	2,0	-	3,0	6 ad/pcs
150-2500-1410	Alüminyum Kulp Profili / Aluminium Handle Profile	Eloksal / Mat Anodized	mt.	-	-	2,0	-	3,0	6 ad/pcs
150-1420-1420	Alüminyum Kapama Profili / Aluminium Closure Profile	Parlak / Bright	mt.	-	-	-	-	3,0	10 ad/pcs

Multiline SRG 125

70 KG SÜRME KAPAK SİSTEMİ • SLIDING DOOR SYSTEM

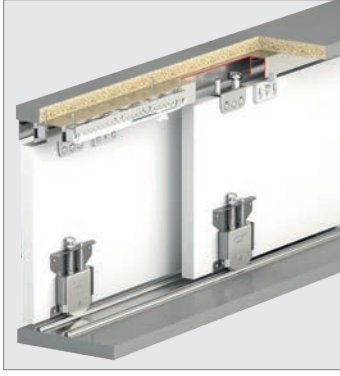

Bilgi / Information

- 1 Kutu İçeriği : 2 Kapak Mekanizma + 4 Ad Yavaşlatıcı
- In 1 box : 2 Door Mechanism + 4 Pcs Soft Closers



SRG 125 1 Set İçeriği / 1 Set Includes

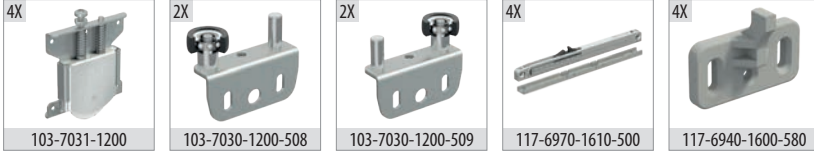

Ray Profilleri / Rail Profiles

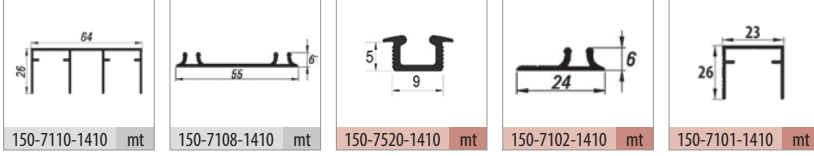

Kulp Profilleri / Handle Profiles

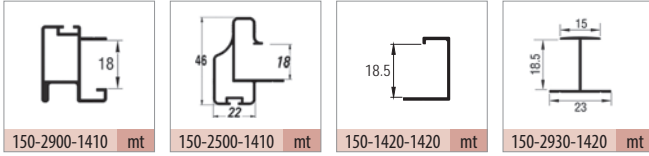

Opsiyonel Aksesuar / Optional Accessories



Teknik Detay / Technical Detail

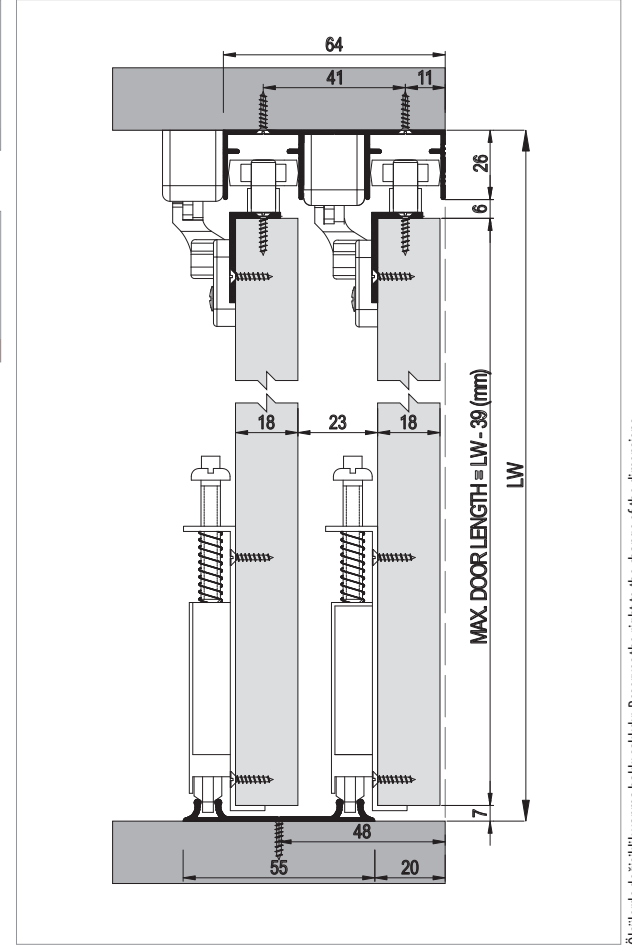

Ölçülerde değişiklik yapma hakkı saklıdır. Reserves the right to the change of the dimensions.

Kod / Code No	Açıklama / Description	Renk / Colour	Birim / Unit			Profil mt. / Profiles mt.			Bağ / Bnd.
103-0125-1200	SRG 125 - Sürme Kapak Sistemi / Sliding Door System	Silver	2 Kapak / 1 Set	12	360	-	-	-	-
117-1011-1600	Plastik Ray Tapası / Plastic Stopper	Gri / Grey	1 Adet / 1 Pcs	1.000	120.000	-	-	-	-
150-7110-1410	Alüminyum Üst Ray Profili / Aluminium Top Rail Profile	Eloksal / Mat Anodized	mt.	-	-	2,0	2,5	3,0	6 ad/pcs
150-7108-1410	Alüminyum Alt Ray Profili / Aluminium Bottom Rail Profile	Eloksal / Mat Anodized	mt.	-	-	2,0	2,5	3,0	12 ad/pcs
150-7520-1410	Alüminyum Alt Ray Profili / Aluminium Bottom Rail Profile	Eloksal / Mat Anodized	mt.	-	-	-	-	3,0	30 ad/pcs
150-7102-1410	Alüminyum Alt Ray Profili / Aluminium Bottom Rail Profile	Eloksal / Mat Anodized	mt.	-	-	-	-	3,0	20 ad/pcs
150-7101-1410	Alüminyum Üst Ray Profili / Aluminium Top Rail Profile	Eloksal / Mat Anodized	mt.	-	-	-	-	3,0	12 ad/pcs
150-2900-1410	Alüminyum Kulp Profili / Aluminium Handle Profile	Eloksal / Mat Anodized	mt.	-	-	2,0	-	3,0	6 ad/pcs
150-2500-1410	Alüminyum Kulp Profili / Aluminium Handle Profile	Eloksal / Mat Anodized	mt.	-	-	2,0	-	3,0	6 ad/pcs
150-1420-1420	Alüminyum Kapama Profili / Aluminium Closure Profile	Parlak / Bright	mt.	-	-	-	-	3,0	10 ad/pcs
150-2930-1420	Alüminyum Orta Kayıt / Aluminium Horizontal Central	Parlak / Bright	mt.	-	-	-	-	3,0	10 ad/pcs

Multiline SRG 135

60 KG SÜRME KAPAK SİSTEMİ • SLIDING DOOR SYSTEM

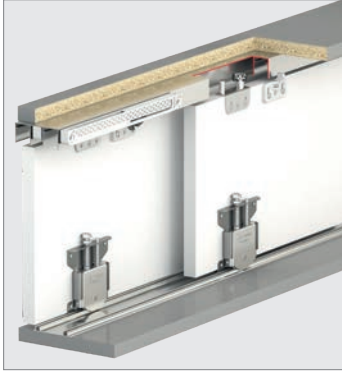

Bilgi / Information

- 1 Kutu İçeriği : 2 Kapak Mekanizma + 4 Ad Yavaşlatıcı
- In 1 box : 2 Door Mechanism + 4 Pcs Soft Closers



SRG 135 1 Set İçeriği / 1 Set Includes

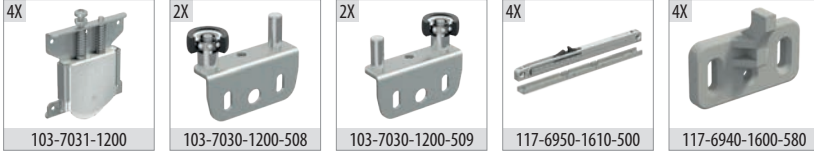

Ray Profilleri / Rail Profiles

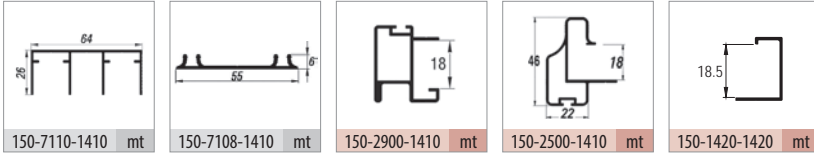

Kulp Profilleri / Handle Profiles

Teknik Detay / Technical Detail

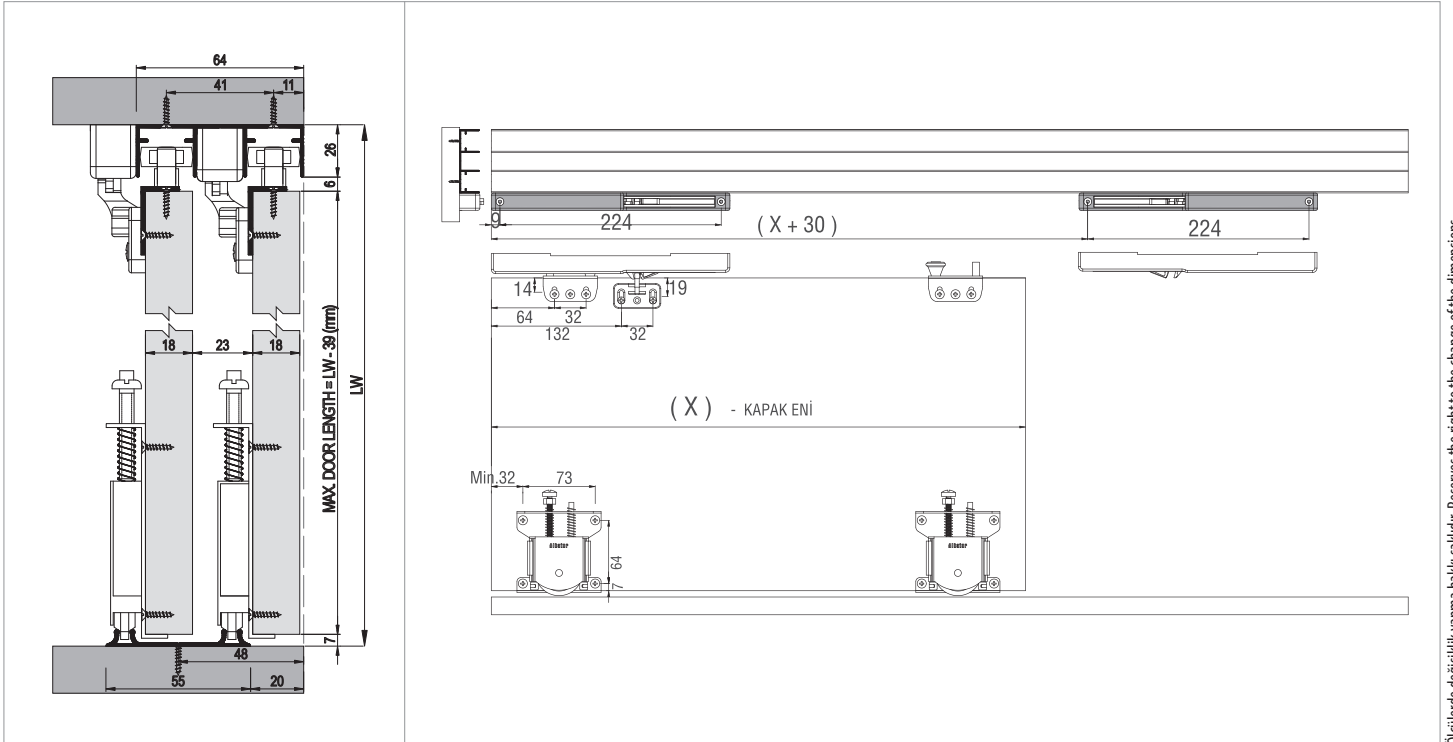

Ölçülerde değişiklik yapma hakkı saklıdır. Reserves, the right to the change of the dimensions.

Kod / Code No	Açıklama / Description	Renk / Colour	Birim / Unit			Profil mt. / Profiles mt.			Bağ / Bnd.
103-0135-1200	SRG 135 - Sürme Kapak Sistemi / Sliding Door System	Silver	2 Kapak / 1 Set	12	360	-	-	-	-
150-7110-1410	Alüminyum Üst Ray Profili / Aluminium Top Rail Profile	Eloksal / Mat Anodized	mt.	-	-	2,0	2,5	3,0	6 ad/pcs
150-7108-1410	Alüminyum Alt Ray Profili / Aluminium Bottom Rail Profile	Eloksal / Mat Anodized	mt.	-	-	2,0	2,5	3,0	12 ad/pcs
150-2900-1410	Alüminyum Kulp Profili / Aluminium Handle Profile	Eloksal / Mat Anodized	mt.	-	-	2,0	-	3,0	6 ad/pcs
150-2500-1410	Alüminyum Kulp Profili / Aluminium Handle Profile	Eloksal / Mat Anodized	mt.	-	-	2,0	-	3,0	6 ad/pcs
150-1420-1420	Alüminyum Kapama Profili / Aluminium Closure Profile	Parlak / Bright	mt.	-	-	-	-	3,0	10 ad/pcs

Multiline 7030

75 KG SÜRME KAPAK SİSTEMİ • SLIDING DOOR SYSTEM



Bilgi / Information

- 1 Kutu İçeriği : 2 Kapak Mekanizma
- In 1 box : 2 Door Mechanism

Yavaşlatıcı Alternatifi / Soft Closer Alternative

- 117-6942-1610 <<>> 117-6950-1610 <<>> 117-6970-1610 <<>>
- 117-6940-1600 <<>> 117-6666-1610 >> 117-6710-1610 >>



7030 1 Takım İçeriği / 1 Kit Includes

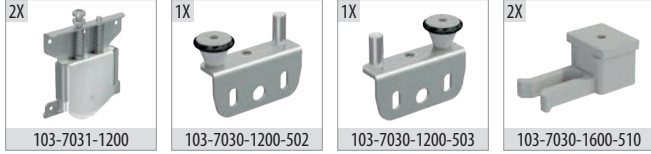

Ray Profilleri / Rail Profiles

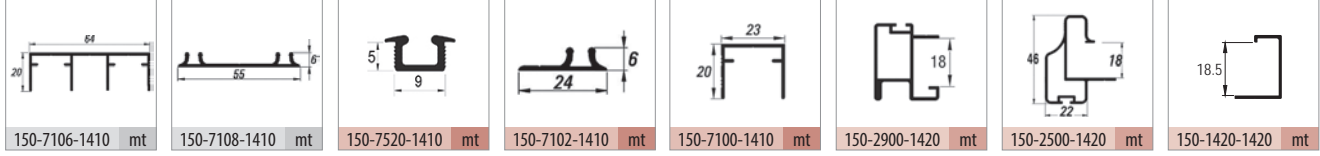

Kulp Profilleri / Handle Profiles

Teknik Detay / Technical Detail

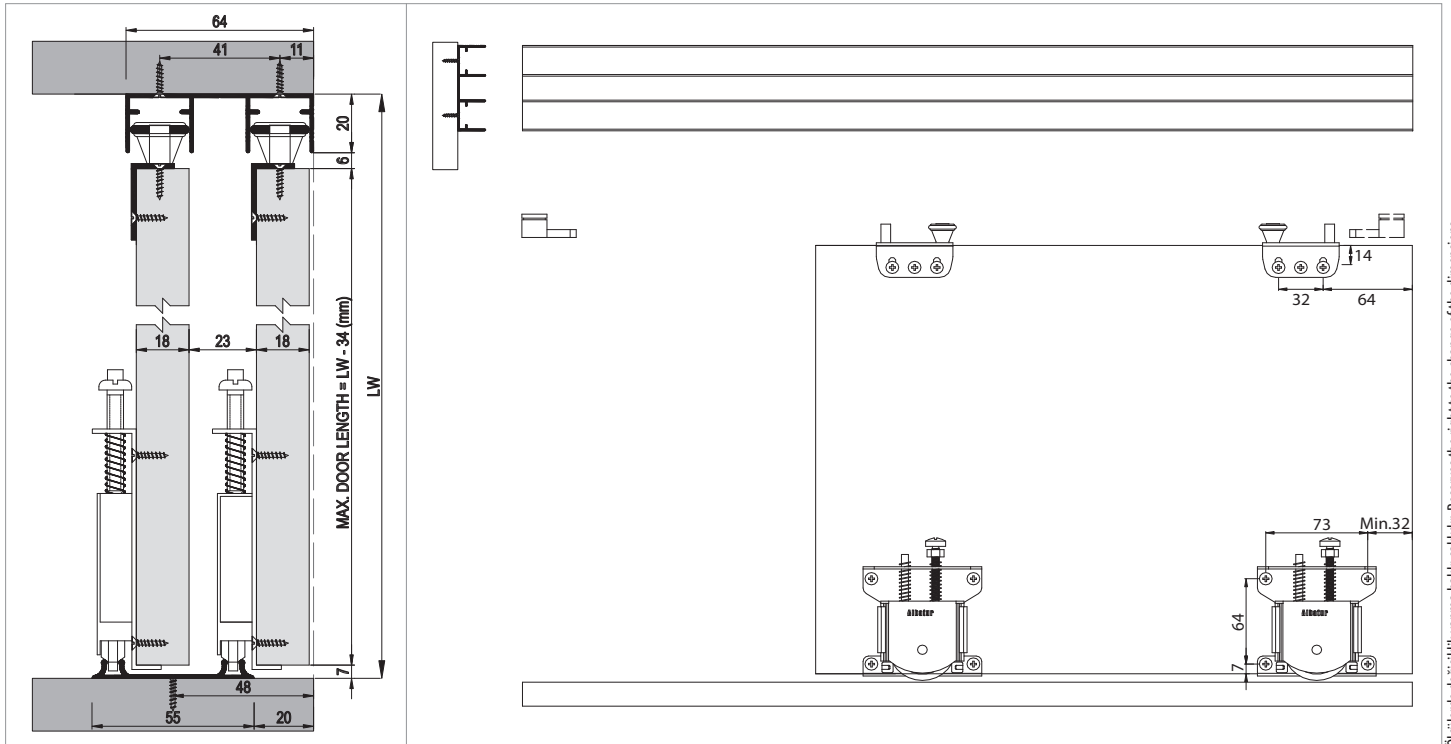

Ölçülerde değişiklik yapma hakkı saklıdır. Reserves the right to the change of the dimensions.

Kod / Code No	Açıklama / Description	Renk / Colour	Birim / Unit			Profil mt. / Profiles mt.			Bağ / Bnd.
103-7030-1200	7030 - Sürme Kapak Sistemi / Sliding Door System	Silver	1 Kapak / 1 Kit	32	1.024	-	-	-	-
150-7106-1410	Alüminyum Üst Ray Profili / Aluminium Top Rail Profile	Eloksal / Mat Anodized	mt.	-	-	2,0	2,5	3,0	6 ad/pcs
150-7108-1410	Alüminyum Alt Ray Profili / Aluminium Bottom Rail Profile	Eloksal / Mat Anodized	mt.	-	-	2,0	2,5	3,0	12 ad/pcs
150-2900-1420	Alüminyum Kulp Profili / Aluminium Handle Profile	Parlak / Bright	mt.	-	-	2,0	2,5	3,0	6 ad/pcs
150-2500-1420	Alüminyum Kulp Profili / Aluminium Handle Profile	Parlak / Bright	mt.	-	-	2,0	-	3,0	6 ad/pcs
150-1420-1420	Alüminyum Kapama Profili / Aluminium Closure Profile	Parlak / Bright	mt.	-	-	-	-	3,0	10 ad/pcs



Yavaşlatıcı Alternatifi / Soft Closer Alternative

117-6666-1610 ►► 117-6710-1610 ►►



7031

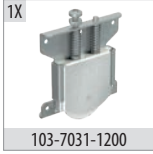

Ray Profilleri / Rail Profiles

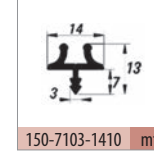
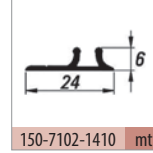
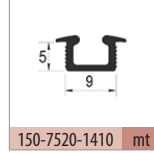
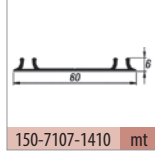
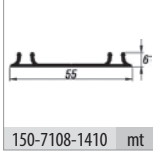

Kulp Profilleri / Handle Profiles

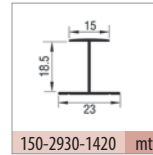
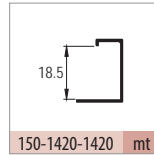
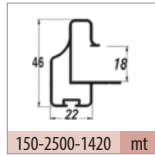
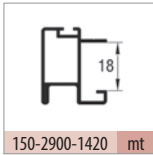

Opsiyonel Aksesuar / Optional Accessories

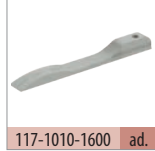

Teknik Detay / Technical Detail

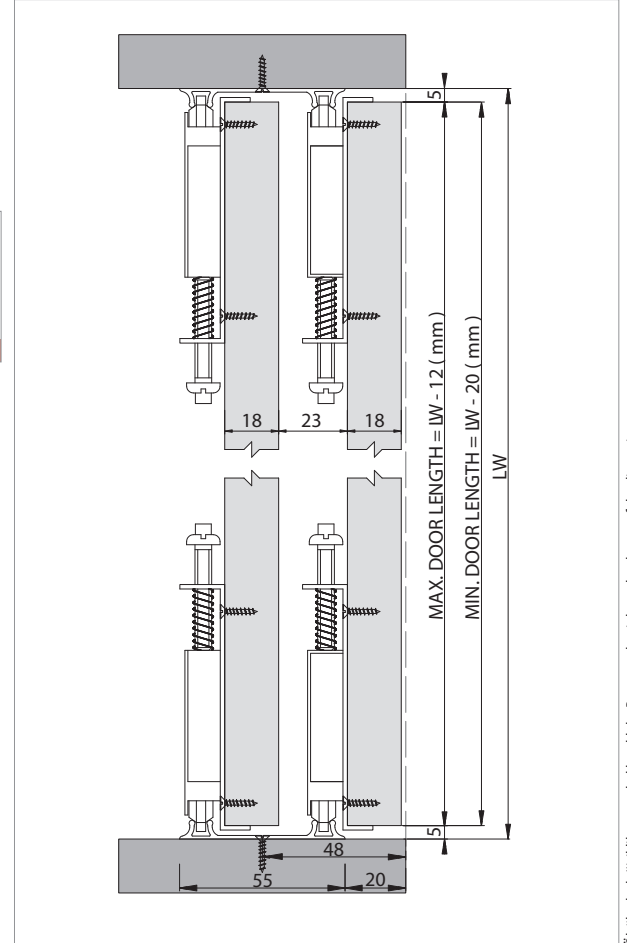

Ölçülerde değişiklik yapma hakkı saklıdır. Reserves the right to the change of the dimensions.

Kod / Code No	Açıklama / Description	Renk / Colour	Birim / Unit			Profil mt. / Profiles mt.			Bağ / Bnd.
103-7031-1200	Sürme Kapak Sistemi / Sliding Door System	Silver	1 Adet / 1 Pcs	96	3.072	-	-	-	-
117-1010-1600	Plastik Stoper / Plastic Stopper	Gri / Grey	1 Adet / 1 Pcs	1.056	126.000	-	-	-	-
117-1011-1600	Plastik Ray Tapası / Plastic Stopper	Gri / Grey	1 Adet / 1 Pcs	1.000	120.000	-	-	-	-
150-7108-1410	Alüminyum Alt-Üst Ray / Aluminium Bottom-Top Rail	Eloksal / Mat Anodized	mt.	-	-	2,0	2,5	3,0	12 ad/pcs
150-7107-1410	Alüminyum Alt-Üst Ray / Aluminium Bottom-Top Rail	Eloksal / Mat Anodized	mt.	-	-	2,0	2,5	3,0	12 ad/pcs
150-7520-1410	Alüminyum Alt-Üst Ray / Aluminium Bottom-Top Rail	Eloksal / Mat Anodized	mt.	-	-	-	-	3,0	30 ad/pcs
150-7102-1410	Alüminyum Alt-Üst Ray / Aluminium Bottom-Top Rail	Eloksal / Mat Anodized	mt.	-	-	-	-	3,0	20 ad/pcs
150-7103-1410	Alüminyum Alt-Üst Ray / Aluminium Bottom-Top Rail	Eloksal / Mat Anodized	mt.	-	-	-	-	3,0	30 ad/pcs
150-2900-1420	Alüminyum Kulp Profili / Aluminium Handle Profile	Parlak / Bright	mt.	-	-	2,0	2,5	3,0	6 ad/pcs
150-2500-1420	Alüminyum Kulp Profili / Aluminium Handle Profile	Parlak / Bright	mt.	-	-	2,0	-	3,0	6 ad/pcs
150-1420-1420	Alüminyum Kapama Profili / Aluminium Closure Profile	Parlak / Bright	mt.	-	-	-	-	3,0	10 ad/pcs
150-2930-1420	Alüminyum Orta Kayıt / Aluminium Horizontal Central	Parlak / Bright	mt.	-	-	-	-	3,0	10 ad/pcs



Bilgi / Information

- 1 Kutu İçeriği : 2 Kapak Mekanizma
- In 1 box : 2 Door Mechanism

Yavaşlatıcı Alternatifi / Soft Closer Alternative

- 117-6950-1610 <<>> 117-6970-1610 <<>> 117-6810-1600 <<>>
- 117-6940-1600 <<>> 117-6666-1610 >> 117-6710-1610 >>



7032 1 Takım İçeriği / 1 Kit Includes

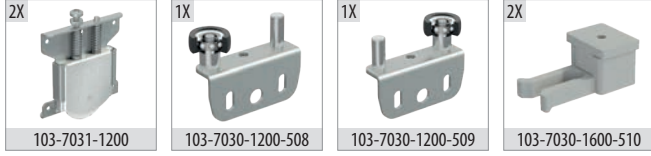

Ray Profilleri / Rail Profiles

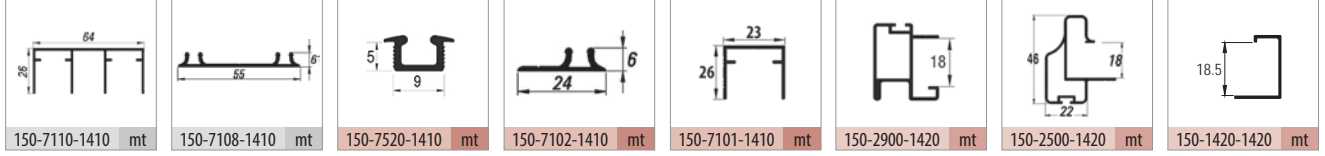

Kulp Profilleri / Handle Profiles

Teknik Detay / Technical Detail

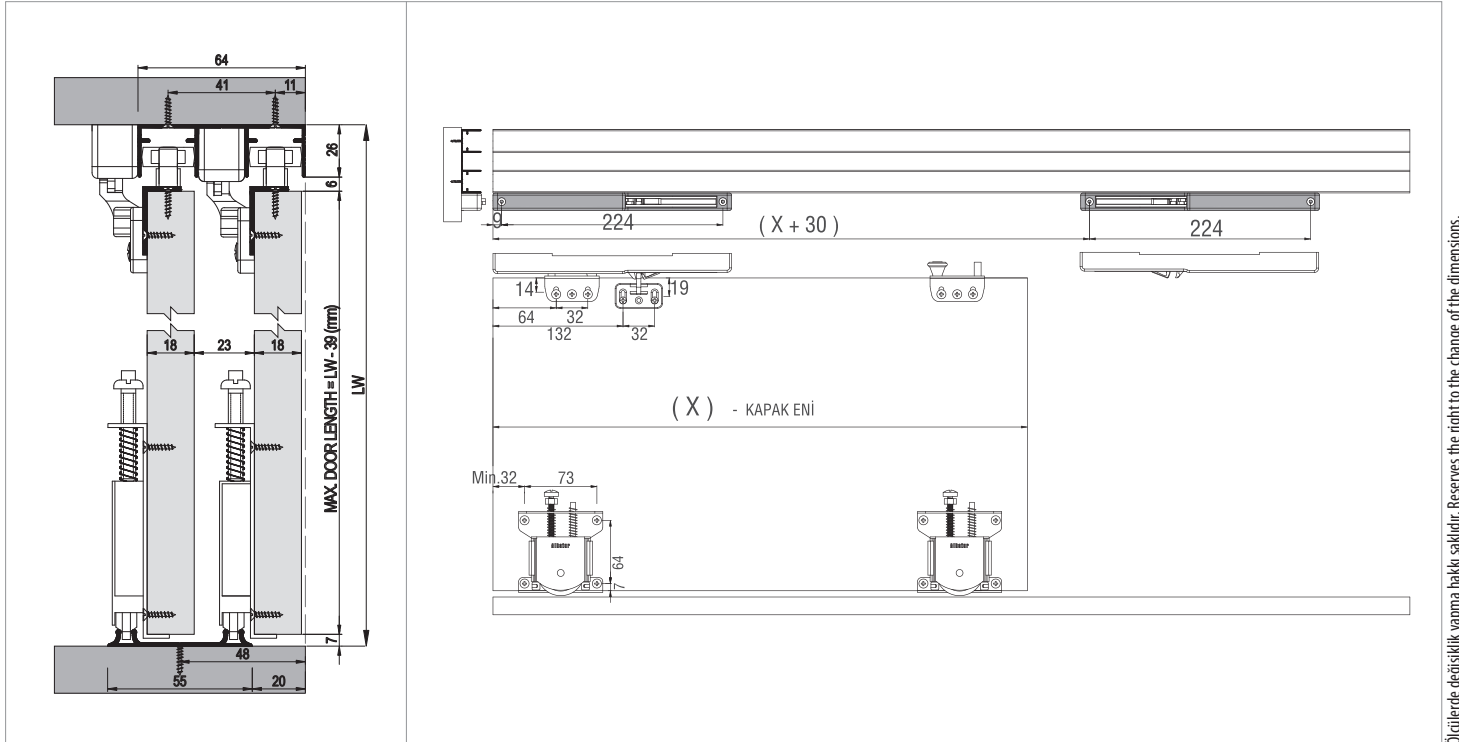

Ölçülerde değişiklik yapma hakkı saklıdır. Reserves the right to the change of the dimensions.

Kod / Code No	Açıklama / Description	Renk / Colour	Birim / Unit			Profil mt. / Profiles mt.	Bağ / Bnd.
103-7032-1200	7030 SFT -75 Kg Sürme Kapak Sistemi / 75 Kg Sliding Door System	Silver	1 Kapak / 1 Kit	32	1.024	- - -	-
150-7110-1410	Alüminyum Üst Ray Profili / Aluminium Top Rail Profile	Eloksal / Mat Anodized	mt.	-	-	2,0 2,5 3,0	6 ad/pcs
150-7108-1410	Alüminyum Alt Ray Profili / Aluminium Bottom Rail Profile	Eloksal / Mat Anodized	mt.	-	-	2,0 2,5 3,0	12 ad/pcs
150-2900-1420	Alüminyum Kulp Profili / Aluminium Handle Profile	Parlak / Bright	mt.	-	-	2,0 2,5 3,0	6 ad/pcs
150-2500-1420	Alüminyum Kulp Profili / Aluminium Handle Profile	Parlak / Bright	mt.	-	-	2,0 - 3,0	6 ad/pcs
150-1420-1420	Alüminyum Kapama Profili / Aluminium Closure Profile	Parlak / Bright	mt.	-	-	- - 3,0	10 ad/pcs

Multiline 7010

80 KG SÜRME KAPAK SİSTEMİ • SLIDING DOOR SYSTEM

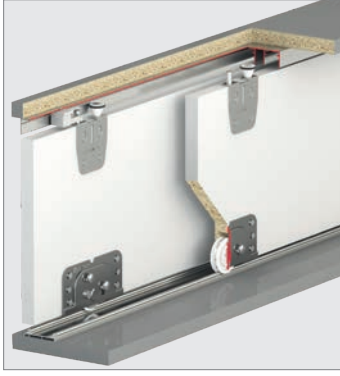

Bilgi / Information

- 1 Kutu İçeriği : 2 Kapak Mekanizma
- In 1 box : 2 Door Mechanism



Yavaşlatıcı Alternatifi / Soft Closer Alternative

- 117-6950-1610 <<>>
- 117-6970-1610 <<>>
- 117-6942-1610 <<>>
- 117-6940-1600 <<>>
- 117-6666-1610 >>
- 117-6710-1610 >>

7010 1 Takım İçeriği / 1 Kit Includes

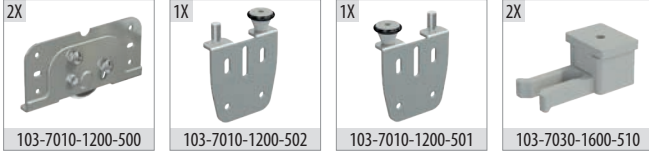

Ray Profilleri / Rail Profiles

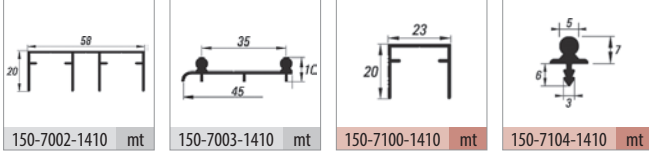

Kulp Profilleri / Handle Profiles

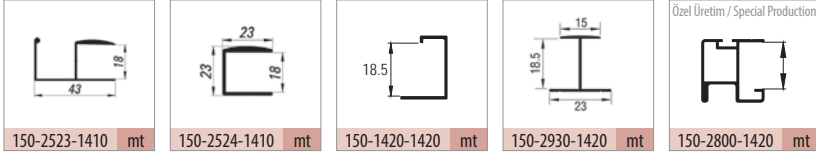

Uygulama / Application



Teknik Detay / Technical Detail

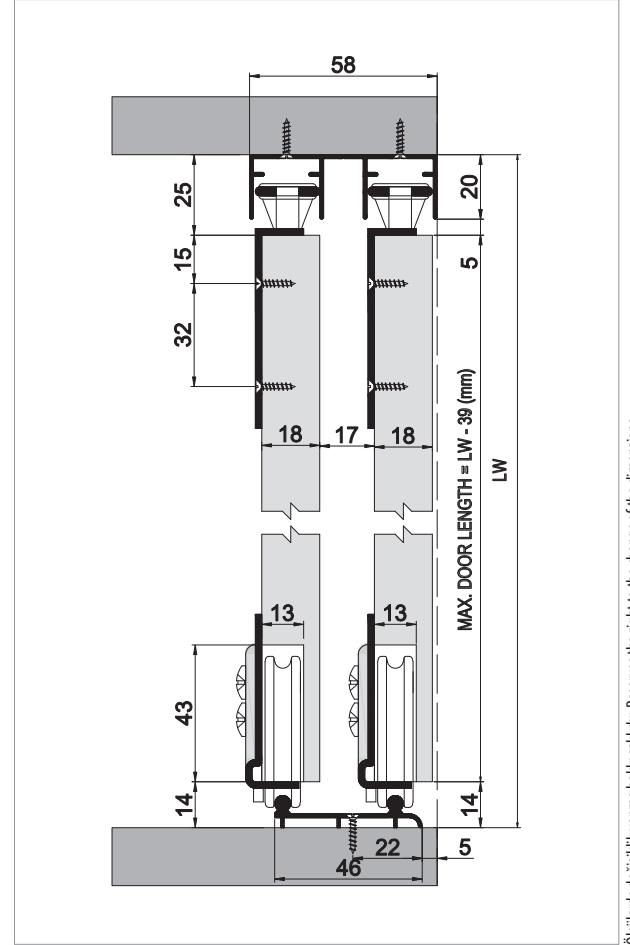

Kod / Code No	Açıklama / Description	Renk / Colour	Birim / Unit			Profil mt. / Profiles mt.			Bağ / Bnd.
103-7010-1200	80 Kg Sürme Kapak Sistemi / 80 Kg Sliding Door System	Silver	1 Kapak / 1 Kit	32	1.024	-	-	-	-
150-7002-1410	Alüminyum Üst Ray Profili / Aluminium Top Rail Profile	Eloksal / Mat Anodized	mt.	-	-	2,0		3,0	10 ad/pcs
150-7003-1410	Alüminyum Alt Ray Profili / Aluminium Bottom Rail Profile	Eloksal / Mat Anodized	mt.	-	-	2,0		3,0	10 ad/pcs
150-7100-1410	Alüminyum Üst Ray Profili / Aluminium Top Rail Profile	Eloksal / Mat Anodized	mt.	-	-	2,0	2,5	3,0	12 ad/pcs
150-7104-1410	Alüminyum Alt Ray Profili / Aluminium Bottom Rail Profile	Eloksal / Mat Anodized	mt.	-	-	2,0	-	3,0	50 ad/pcs
150-2523-1410	Alüminyum Kulp Profili / Aluminium Handle Profile	Eloksal / Mat Anodized	mt.	-	-	-	2,5	3,0	10 ad/pcs
150-2524-1410	Alüminyum Kapama Profili / Aluminium Closure Profile	Eloksal / Mat Anodized	mt.	-	-	-	2,5	3,0	10 ad/pcs
150-1420-1420	Alüminyum Kapama Profili / Aluminium Closure Profile	Parlak / Bright	mt.	-	-	-	-	3,0	10 ad/pcs
150-2930-1420	Alüminyum Orta Kayıt / Aluminium Horizontal Central	Parlak / Bright	mt.	-	-	-	-	3,0	10 ad/pcs
150-2800-1420	Alüminyum Kulp Profili / Aluminium Handle Profile	Parlak / Bright	mt.	-	-	-	-	3,0	6 ad/pcs

Multiline 6400

45 KG SÜRME KAPAK SİSTEMİ • SLIDING DOOR SYSTEM

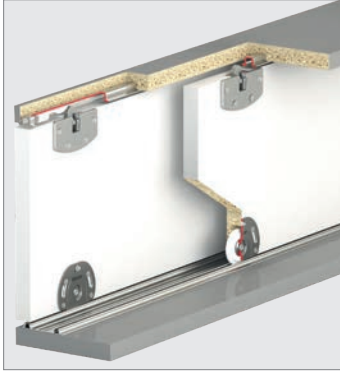

Bilgi / Information

- 1 Kutu İçeriği : 4 Kapak Mekanizma
- In 1 box : 4 Door Mechanism



Yavaşlatıcı Alternatifi / Soft Closer Alternative

117-6942-1610 ► 117-6666-1610 ► 117-6710-1610 ►

6400 1 Takım İçeriği / 1 Kit Includes

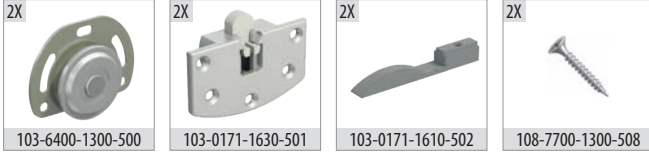

Ray Profilleri / Rail Profiles

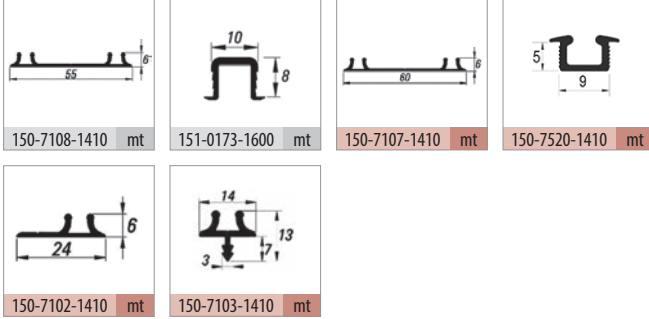

Kulp Profilleri / Handle Profiles

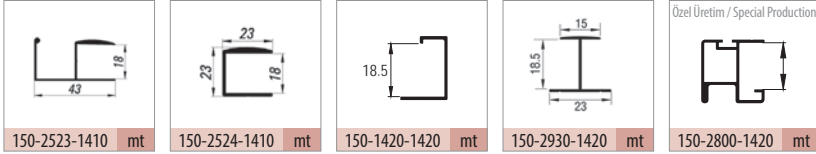

Opsiyonel Aksesuar / Optional Accessories



Teknik Detay / Technical Detail

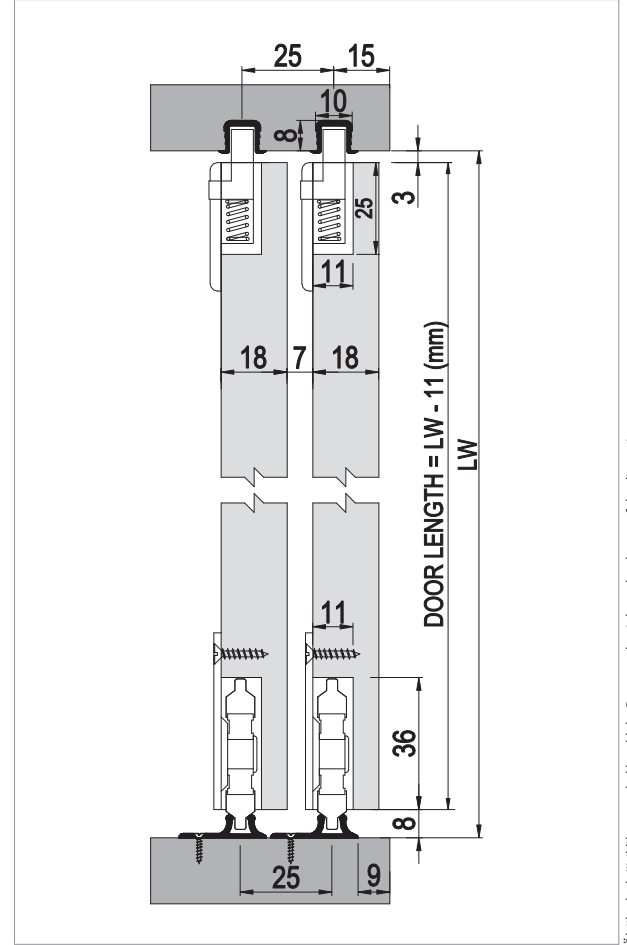

Ölçülerde değişiklik yapma hakkı saklıdır. Reserves the right to the change of the dimensions.

Kod / Code No	Açıklama / Description	Renk / Colour	Birim / Unit			Profil mt. / Profiles mt.			Bağ / Bnd.
103-6400-1300	45 Kg Sürme Kapak Sistemi / 45 Kg Sliding Door System	Galveniz / Galvanized	1 Kapak / 1 Kit	96	2.304	-	-	-	-
150-7108-1410	Alüminyum Alt Ray Profili / Aluminium Bottom Rail Profile	Eloksal / Mat Anodized	mt.	-	-	2,0	2,5	3,0	12 ad/pcs
151-0173-1600	PVC Üst Ray Profili / PVC Top Rail Profile	Gri / Grey	mt.	-	-	-	-	3,0	50 ad/pcs
150-7107-1410	Alüminyum Alt Ray Profili / Aluminium Bottom Rail Profile	Eloksal / Mat Anodized	mt.	-	-	2,0	-	3,0	12 ad/pcs
150-7520-1410	Alüminyum Alt Ray Profili / Aluminium Bottom Rail Profile	Eloksal / Mat Anodized	mt.	-	-	-	-	3,0	30 ad/pcs
150-7102-1410	Alüminyum Alt Ray Profili / Aluminium Bottom Rail Profile	Eloksal / Mat Anodized	mt.	-	-	-	-	3,0	20 ad/pcs
150-7103-1410	Alüminyum Alt Ray Profili / Aluminium Bottom Rail Profile	Eloksal / Mat Anodized	mt.	-	-	-	-	3,0	30 ad/pcs
150-2523-1410	Alüminyum Kulp Profili / Aluminium Handle Profile	Eloksal / Mat Anodized	mt.	-	-	-	2,5	3,0	10 ad/pcs
150-2524-1410	Alüminyum Kapama Profili / Aluminium Closure Profile	Eloksal / Mat Anodized	mt.	-	-	-	2,5	3,0	10 ad/pcs
150-1420-1420	Alüminyum Kapama Profili / Aluminium Closure Profile	Parlak / Bright	mt.	-	-	-	-	3,0	10 ad/pcs
150-2930-1420	Alüminyum Orta Kayıt / Aluminium Horizontal Central	Parlak / Bright	mt.	-	-	-	-	3,0	10 ad/pcs

Multiline 7045

45 KG HAFİF SÜRME KAPAK SİSTEMİ • SLIDING LIGHT DUTY DOOR SYSTEM



■ Yavaşlatıcı Alternatifi / Soft Closer Alternative

117-6942-1610 ► 117-6666-1610 ► 117-6710-1610 ►



■ 7045 1 Takım İçeriği / 1 Kit Includes

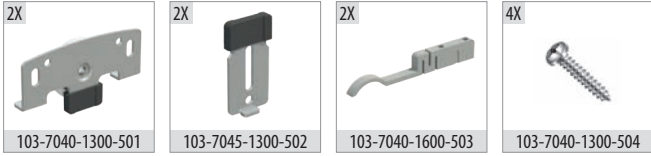

■ Ray Profilleri / Rail Profiles

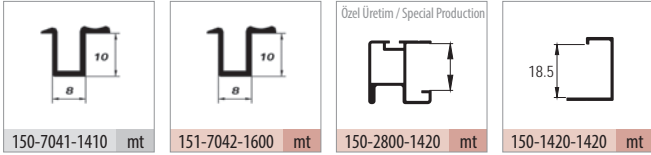

■ Kulp Profilleri / Handle Profiles

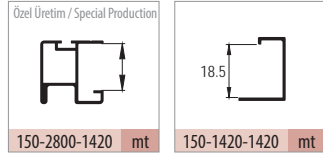

■ Teknik Detay / Technical Detail

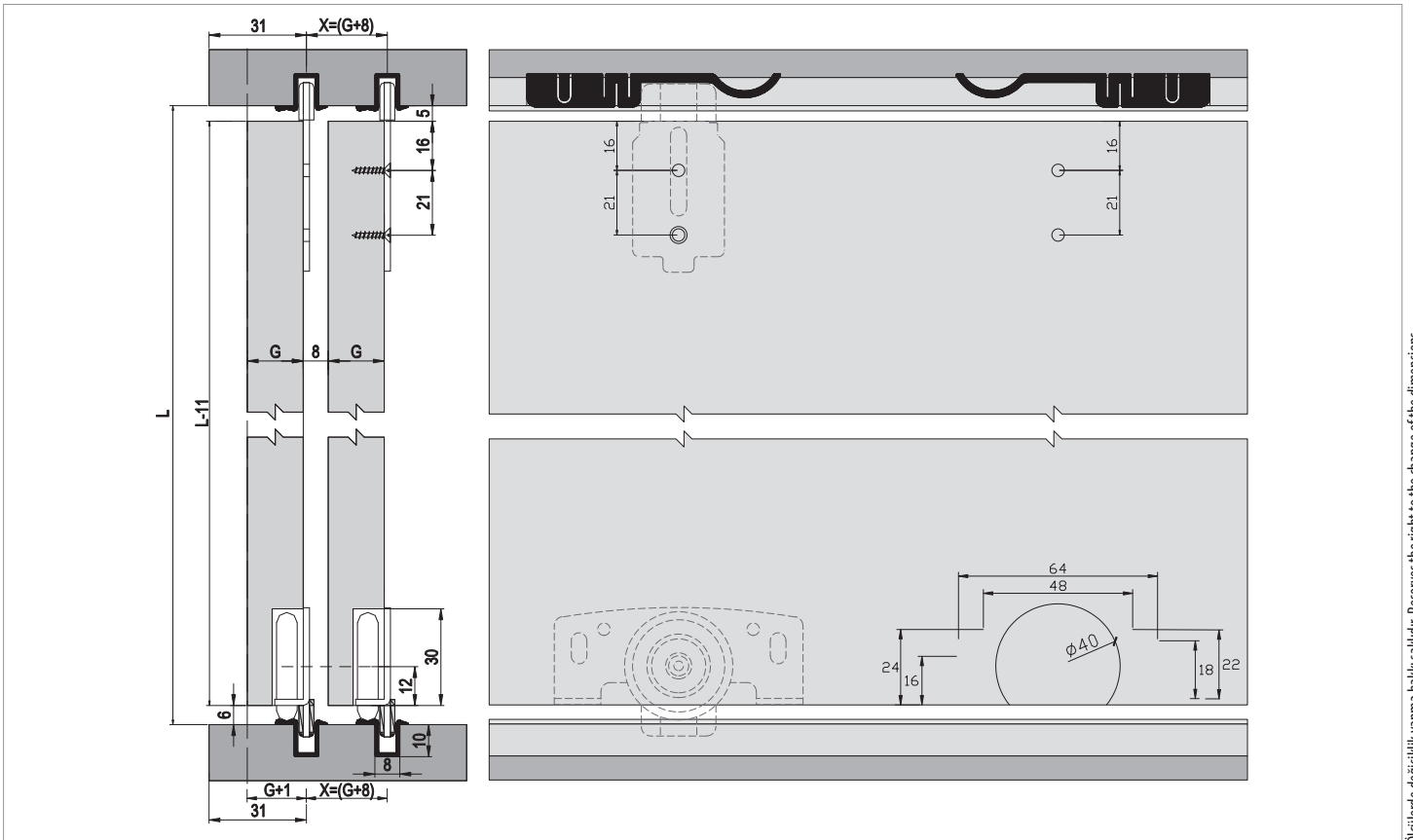

Ölçülerde değişiklik yapma hakkı saklıdır. Reserves the right to the change of the dimensions.

Kod / Code No	Açıklama / Description	Renk / Colour	Birim / Unit			Profil mt. / Profiles mt.	Bağ / Bnd.
103-7045-1300	45 Kg Sürme Kapak Sistemi / 45 Kg Sliding Door System	Galvaniz / Galvanized	1 Kapak / 1 Kit	100	1.800	- - -	-
150-7041-1410	Alüminyum Alt - Üst Ray Profili / Aluminium Top - Bottom Rail Profile	Eloksal / Mat Anodized	mt.	-	-	- - 3,0	50 ad/pcs
151-7042-1600	PVC Alt - Üst Ray Profili / PVC Top - Bottom Rail Profile	Gri / Grey	mt.	-	-	- - 3,0	50 ad/pcs
150-2800-1420	Alüminyum Kulp Profili / Aluminium Handle Profile	Parlak / Bright	mt.	-	-	- - 3,0	6 ad/pcs
150-1420-1420	Alüminyum Kapama Profili / Aluminium Closure Profile	Parlak / Bright	mt.	-	-	- - 3,0	10 ad/pcs

Multiline 6000

40 KG SÜRME KAPAK SİSTEMİ - SLIDING DOOR SYSTEM

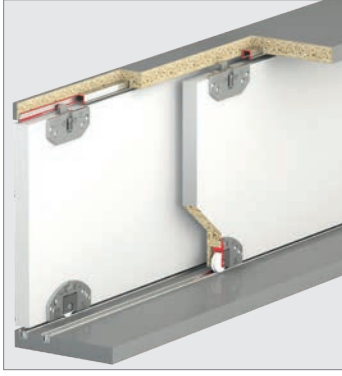

Bilgi / Information

- 1 Kutu İçeriği : 2 Kapak Mekanizma
- In 1 box : 2 Door Mechanism

Yavaşlatıcı Alternatifi / Soft Closer Alternative

117-6666-1610 ▶▶ 117-6710-1610 ▶▶



6000 1 Takım İçeriği / 1 Kit Includes

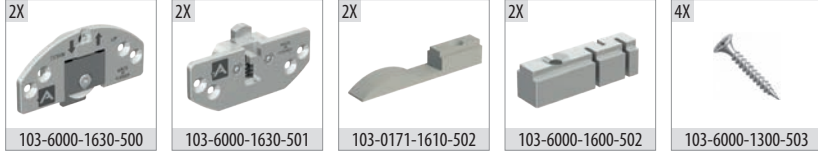

Ray Profilleri / Rail Profiles

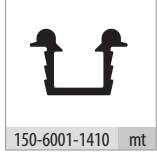

Kulp Profilleri / Handle Profiles

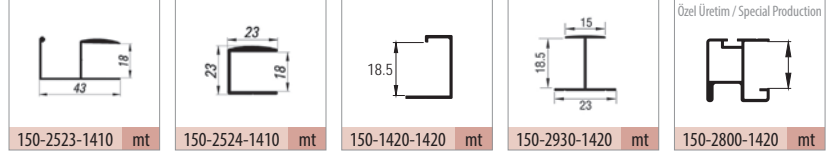

Teknik Detay / Technical Detail

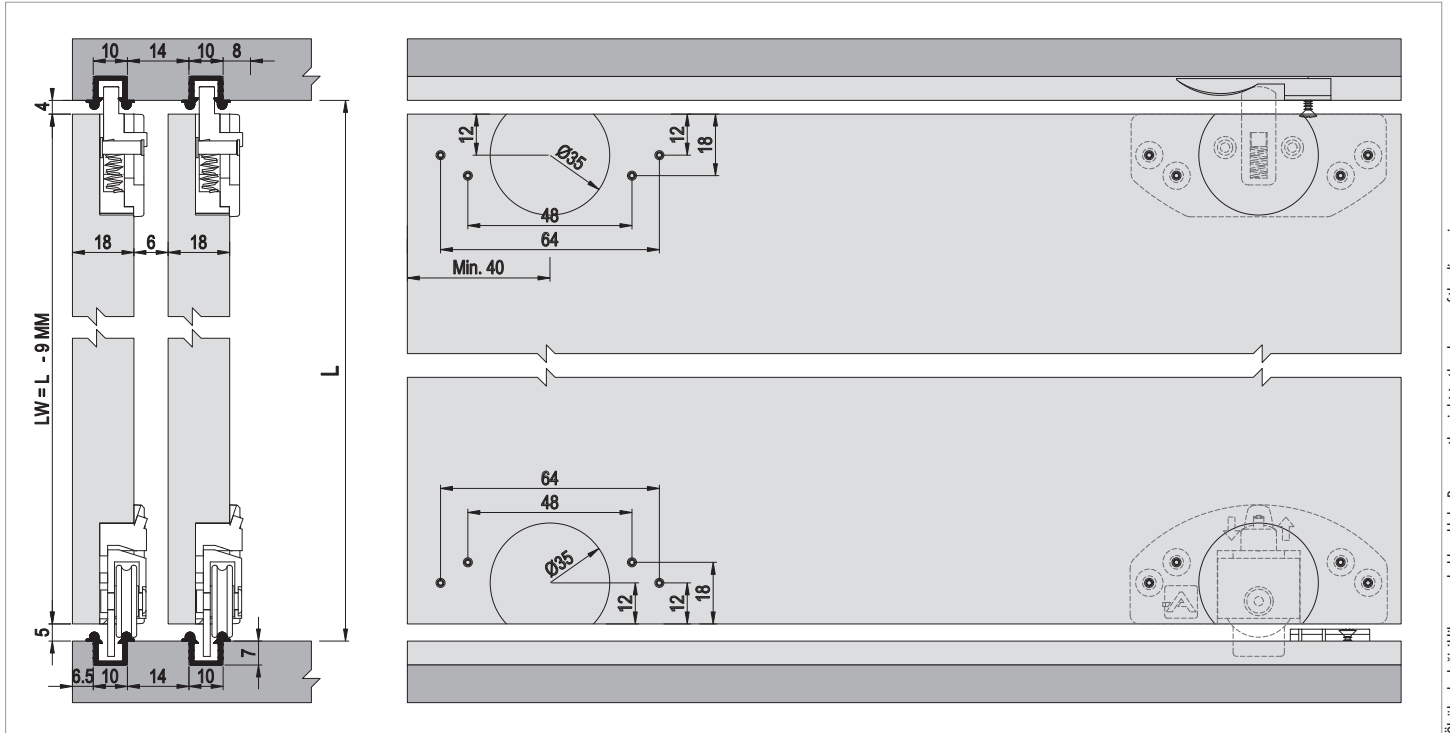

Ölçülerde değişiklik yapma hakkı saklıdır. Reserves the right to the change of the dimensions.

Kod / Code No	Açıklama / Description	Renk / Colour	Birim / Unit			Profil mt. / Profiles mt.			Bağ / Bnd.
103-6000-1630	40 Kg Sürme Kapak Sistemi / 40 Kg Sliding Door System	Siyah / Black	1 Kapak / 1 Kit	48	1.536	-	-	-	-
150-6001-1410	Alüminyum Ray Profili / Aluminium Rail Profile	Eloksal / Mat Anodized	mt.	-	-	-	-	3,0	30 ad/pcs
150-2523-1410	Alüminyum Kulp Profili / Aluminium Handle Profile	Eloksal / Mat Anodized	mt.	-	-	-	2,5	3,0	10 ad/pcs
150-2524-1410	Alüminyum Kapama Profili / Aluminium Closure Profile	Eloksal / Mat Anodized	mt.	-	-	-	2,5	3,0	10 ad/pcs
150-1420-1420	Alüminyum Kapama Profili / Aluminium Closure Profile	Parlak / Bright	mt.	-	-	-	-	3,0	10 ad/pcs
150-2930-1420	Alüminyum Orta Kayıt / Aluminium Horizontal Central	Parlak / Bright	mt.	-	-	-	-	3,0	10 ad/pcs

Multiline 5

20 KG SÜRME KAPAK SİSTEMİ • SLIDING DOOR SYSTEM

Yeni Ürün
New Product



■ Yavaşlatıcı Alternatifi / Soft Closer Alternative

- Sistem üzerinde entegre yavaşlatıcı mevcuttur.
- The system has integrated soft closer.



■ Multiline 5 1 Takım İçeriği / 1 Kit Includes

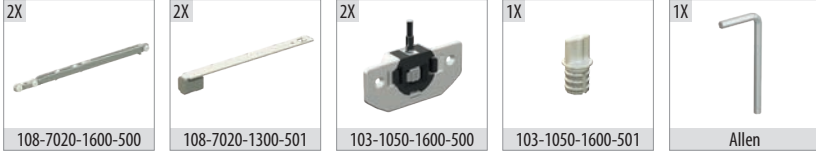

■ Ray Profilleri / Rail Profiles

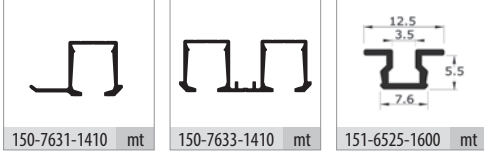

■ Teknik Detay / Technical Detail

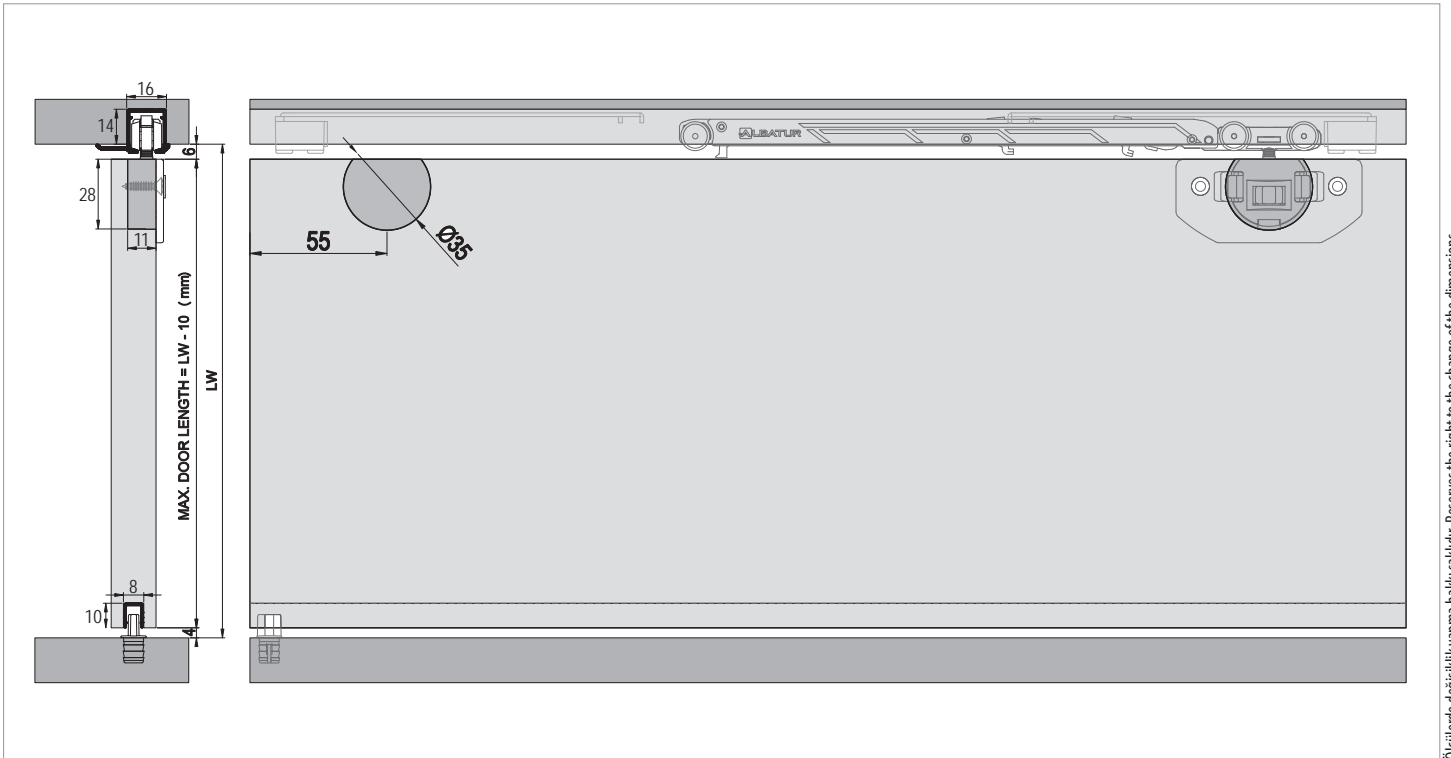

Kod / Code No	Açıklama / Description	Renk / Colour	Birim / Unit			Profil mt. / Profiles mt.	Bağ / Bnd.
103-1050-1600	Multiline 5 - Sürme Gardirop Sistemi / Sliding Wardrobe System	Gri / Grey	1 Kapak / 1 Kit	12	360	- - -	-
150-7631-1410	Alüminyum Üst Ray Profili / Aluminium Top Rail Profile	Eloksal / Mat Anodized	mt.	-	-	- - 3,0	10 ad/pcs
150-7633-1410	Alüminyum Üst Ray Profili / Aluminium Top Rail Profile	Eloksal / Mat Anodized	mt.	-	-	- - 3,0	10 ad/pcs
151-6525-1600	PVC Ray Profili / PVC Rail Profile	Gri / Grey	mt.	-	-	- - 3,0	30 ad/pcs

Multiline 0171

30 KG SÜRME KAPAK SİSTEMİ • SLIDING DOOR SYSTEM

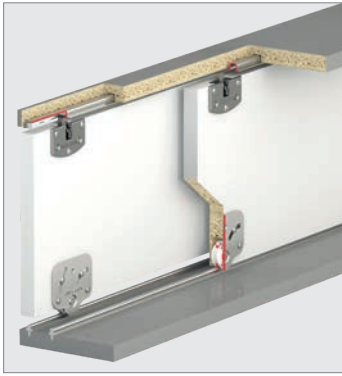

Bilgi / Information

- 1 Kutu İçeriği : 2 Kapak Mekanizma
- In 1 box : 2 Door Mechanism



Yavaşlatıcı Alternatifi / Soft Closer Alternative

117-6942-1610 ▶▶▶ 117-6666-1610 ▶▶▶ 117-6710-1610 ▶▶▶

0171 1 Takım İçeriği / 1 Kit Includes

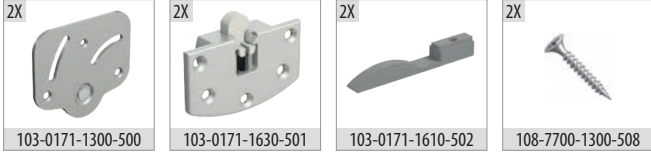

Ray Profilleri / Rail Profiles

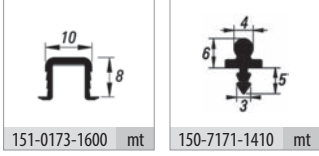

Kulp Profilleri / Handle Profiles

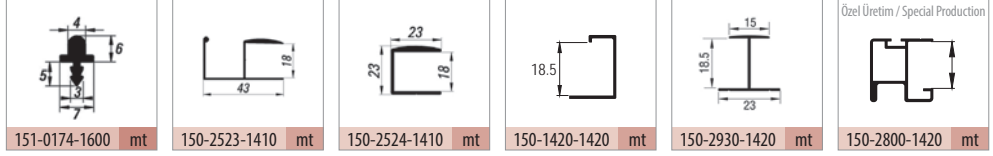

Teknik Detay / Technical Detail

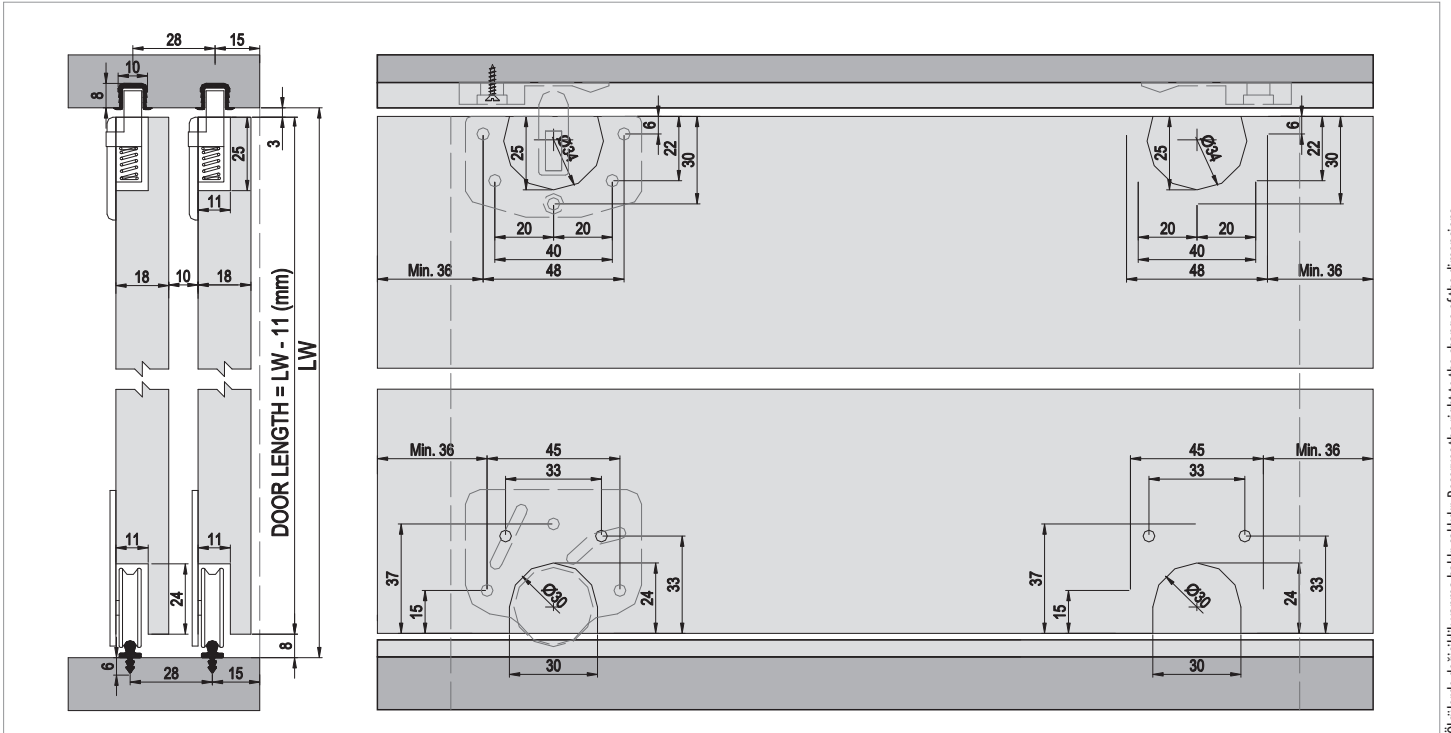

Ölçülerde değişiklik yapma hakkı saklıdır. Reserves the right to the change of the dimensions.

Kod / Code No	Açıklama / Description	Renk / Colour	Birim / Unit			Profil mt. / Profiles mt.	Bağ / Bnd.
103-0171-1300	30 Kg Sürme Kapak Sistemi / 30 Kg Sliding Door System	Galvaniz / Galvanized	1 Kapak / 1 Kit	100	3.200	-	-
151-0173-1600	PVC Ray Profili / PVC Rail Profile	Gri / Grey	mt.	-	-	-	3,0 50 ad/pcs
151-0174-1600	PVC Ray Profili / PVC Rail Profile	Gri / Grey	mt.	-	-	-	3,0 50 ad/pcs
150-7171-1410	Alüminyum Ray Profili / Aluminium Rail Profile	Eloksal / Mat Anodized	mt.	-	-	-	3,0 50 ad/pcs
150-2523-1410	Alüminyum Kulp Profili / Aluminium Handle Profile	Eloksal / Mat Anodized	mt.	-	-	2,5	3,0 10 ad/pcs
150-2524-1410	Alüminyum Kapama Profili / Aluminium Closure Profile	Eloksal / Mat Anodized	mt.	-	-	2,5	3,0 10 ad/pcs
150-1420-1420	Alüminyum Kapama Profili / Aluminium Closure Profile	Parlak / Bright	mt.	-	-	-	3,0 10 ad/pcs
150-2930-1420	Alüminyum Orta Kayıt / Aluminium Horizontal Central	Parlak / Bright	mt.	-	-	-	3,0 10 ad/pcs

WingSlide 7420

40 KG KATLANIR SÜRME GARDIROP SİSTEMİ • SLIDING SYSTEM FOR FOLDING DOORS



Bilgi / Information

- Maksimum kapak yüksekliği 240 cm önerilir.
- Maksimum 40 kg / 1 kapak
- Maksimum kapak eni 60 cm önerilir.
- Max. height of 240 cm
- Maximum 40 kg / 1 door
- Maximum width 60 cm



Yavaşlatıcı Alternatifi / Soft Closer Alternative

- Katlanır kapak sistemlerinde yavaşlatıcı için, yavaşlatıcı menteşe tercih edebilirsiniz.
- For foldable door systems with soft closing, you can prefer soft closing hinge.

7420 1 Takım İçeriği / 1 Kit Includes

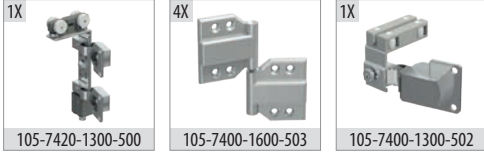

Ray Profilleri / Rail Profiles

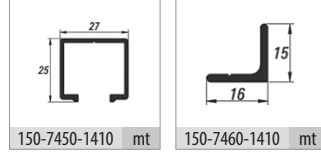

Opsiyonel / Optional



Teknik Detay / Technical Detail

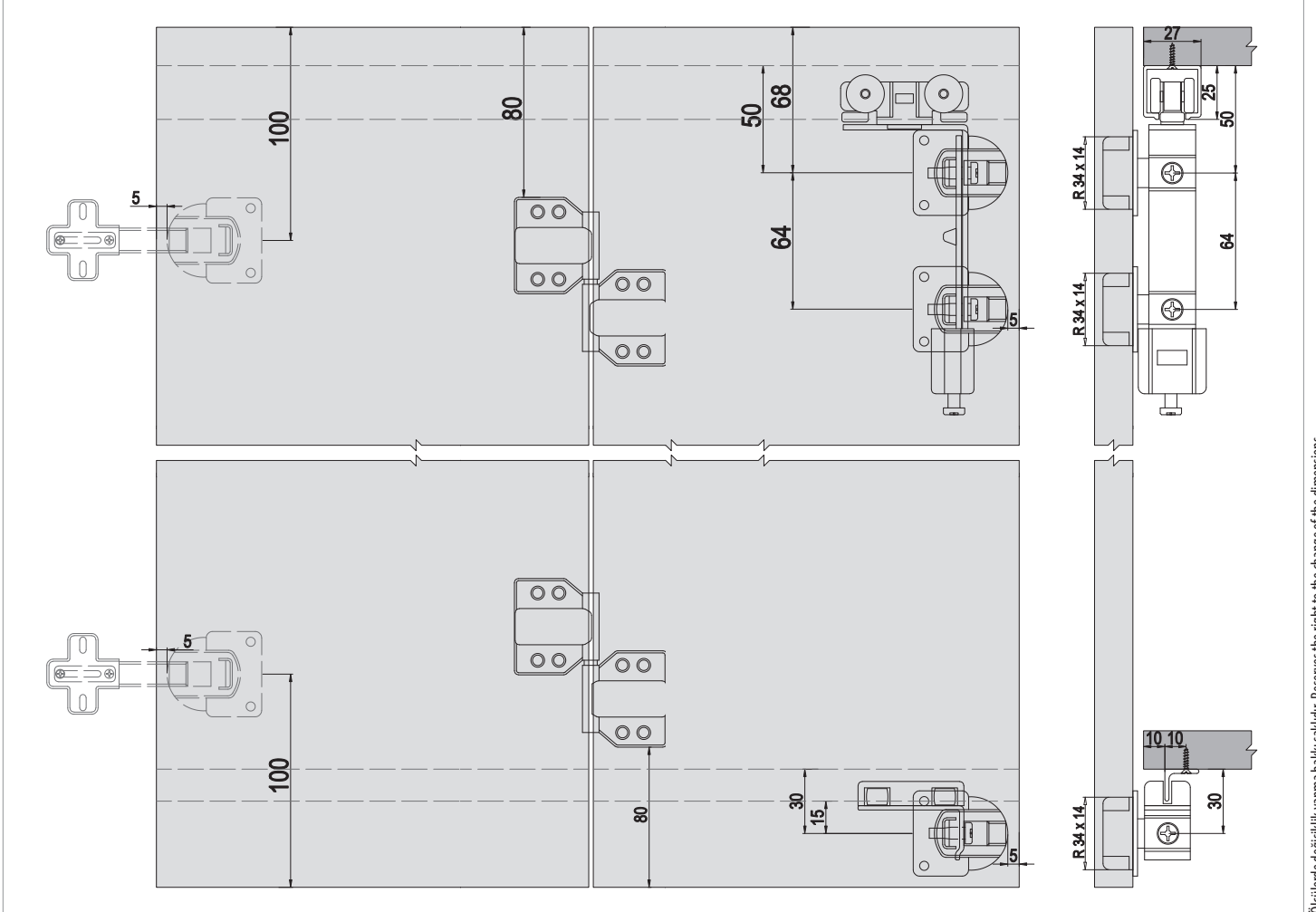

Ölçülerde değişiklik yapma hakkı saklıdır. Reserves the right to the change of the dimensions.

Kod / Code No	Açıklama / Description	Renk / Colour	Birim / Unit			Profil mt. / Profiles mt.	Bağ / Bnd.
105-7420-1300	40 Kg Katlanır Gardirop Sistem / 40 Kg Folding Wardrobe System	Galvaniz / Galvanized	1 Kapak / 1 Kit	24	576	-	-
105-7423-1300	Katlanır Kapak Sac Menteşe / Folding Door Sheet Iron Hinge	Galvaniz / Galvanized	1 Adet / 1 Pcs	250	-	-	-
105-7425-1300	Katlanır Kapak Zamak Menteşe / Folding Door Zinc Hinge	Galvaniz / Galvanized	1 Adet / 1 Pcs	240	-	-	-
105-7426-1700	Kulp Montaj Aparatı / Handle Assembly Kit	Gri / Grey	1 Adet / 1 Pcs	480	-	-	-
150-7450-1410	Alüminyum Üst Ray Profili / Aluminium Top Rail Profile	Eloksal / Mat Anodized	mt.	-	-	2,0	3,0
150-7460-1410	Alüminyum Alt Ray Profili / Aluminium Bottom Rail Profile	Eloksal / Mat Anodized	mt.	-	-	2,0	3,0

WingSlide 7440

40 KG KATLANIR SÜRME GARDIROP SİSTEMİ • SLIDING SYSTEM FOR FOLDING DOORS



Bilgi / Information

- Maksimum kapak yüksekliği 240 cm önerilir.
- Maksimum 40 kg / 1 kapak
- Maksimum kapak eni 60 cm önerilir.
- 2 m'nin üzerindeki kapaklarda ilave menteşe kullanılmalıdır.
- Max. height of 240 cm
- Maximum 40 kg / 1 door
- Maximum width 60 cm
- Should be used additional hinges over 2 mt doors

Yavaşlatıcı Alternatifi / Soft Closer Alternative

- Katlanır kapak sistemlerinde yavaşlatıcı için, yavaşlatıcı menteşe tercih edebilirsiniz.
- For foldable door systems with soft closing, you can prefer soft closing hinge.



7440 1 Takım İçeriği / 1 Kit Includes

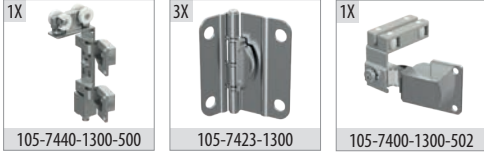

Ray Profilleri / Rail Profiles

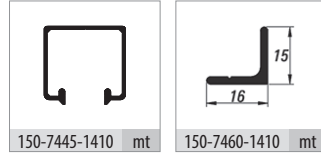

Opsiyonel / Optional



Teknik Detay / Technical Detail

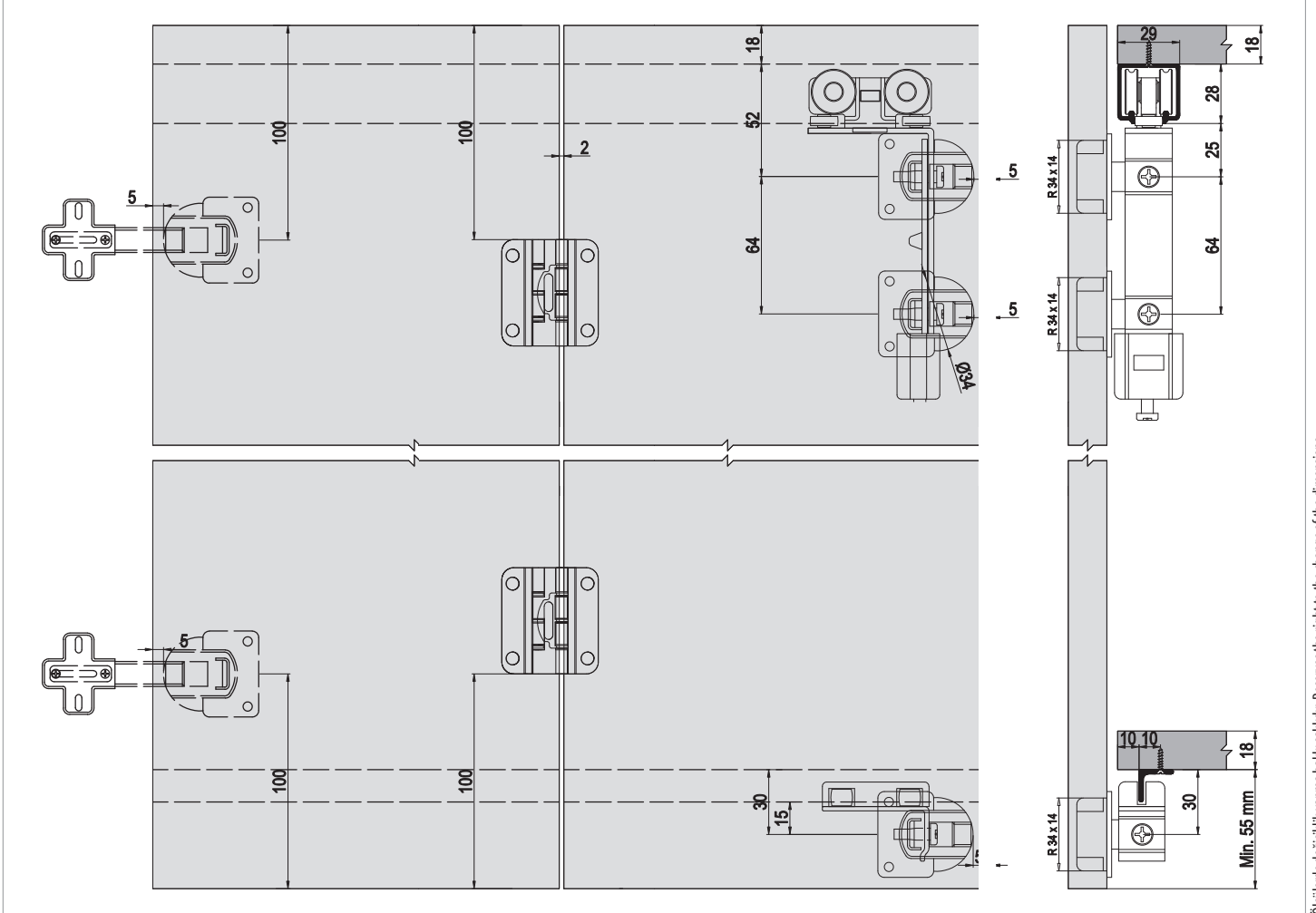

Ölçülerde değişiklik yapma hakkı saklıdır. Reserves the right to the change of the dimensions.

Kod / Code No	Açıklama / Description	Renk / Colour	Birim / Unit			Profil mt. / Profiles mt.	Bağ / Bnd.
105-7440-1300	40 Kg Katlanır Gardirop Sistem / 40 Kg Folding Wardrobe System	Galvaniz / Galvanized	1 Kapak / 1 Kit	24	576	-	-
105-7423-1300	Katlanır Kapak Sac Menteşe / Folding Door Sheet Iron Hinge	Galvaniz / Galvanized	1 Adet / 1 Pcs	250	-	-	-
105-7425-1300	Katlanır Kapak Zamak Menteşe / Folding Door Zinc Hinge	Galvaniz / Galvanized	1 Adet / 1 Pcs	240	-	-	-
105-7426-1700	Kulp Montaj Aparatı / Handle Assembly Kit	Gri / Grey	1 Adet / 1 Pcs	480	-	-	-
150-7445-1410	Alüminyum Üst Ray Profili / Aluminium Top Rail Profile	Eloksal / Mat Anodized	mt.	-	-	2,0	3,0
150-7460-1410	Alüminyum Alt Ray Profili / Aluminium Bottom Rail Profile	Eloksal / Mat Anodized	mt.	-	-	2,0	3,0



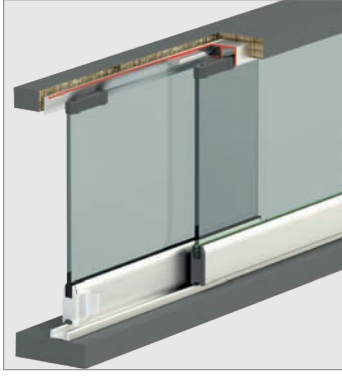

Bilgi / Information

- 4 mm uygulama için 145.1015.1640 fitil kullanılmalıdır.
- For 4 mm applications should be use 145.1015.1640 wick.



7702 1 Takım İçeriği - Kutuda 2 takım / 1 Kit Includes - 2 Set in a Box

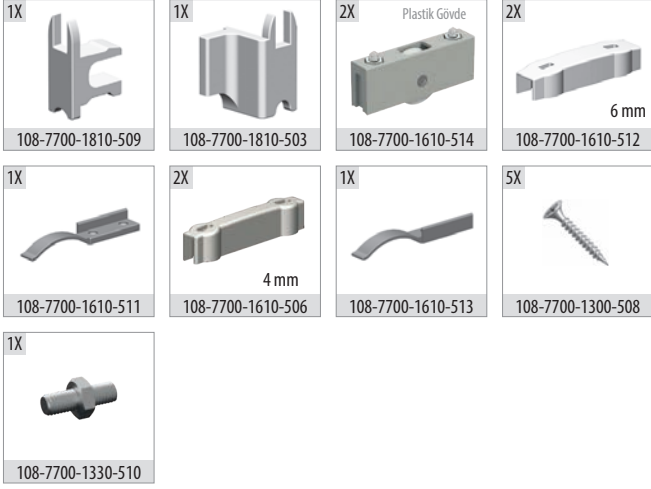

Ray Profilleri / Rail Profiles

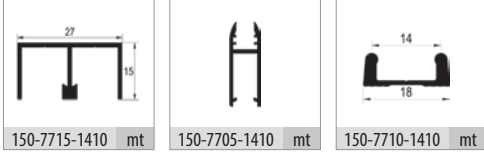

Opsiyonel Aksesuar / Optional Accessories



Teknik Detay / Technical Detail

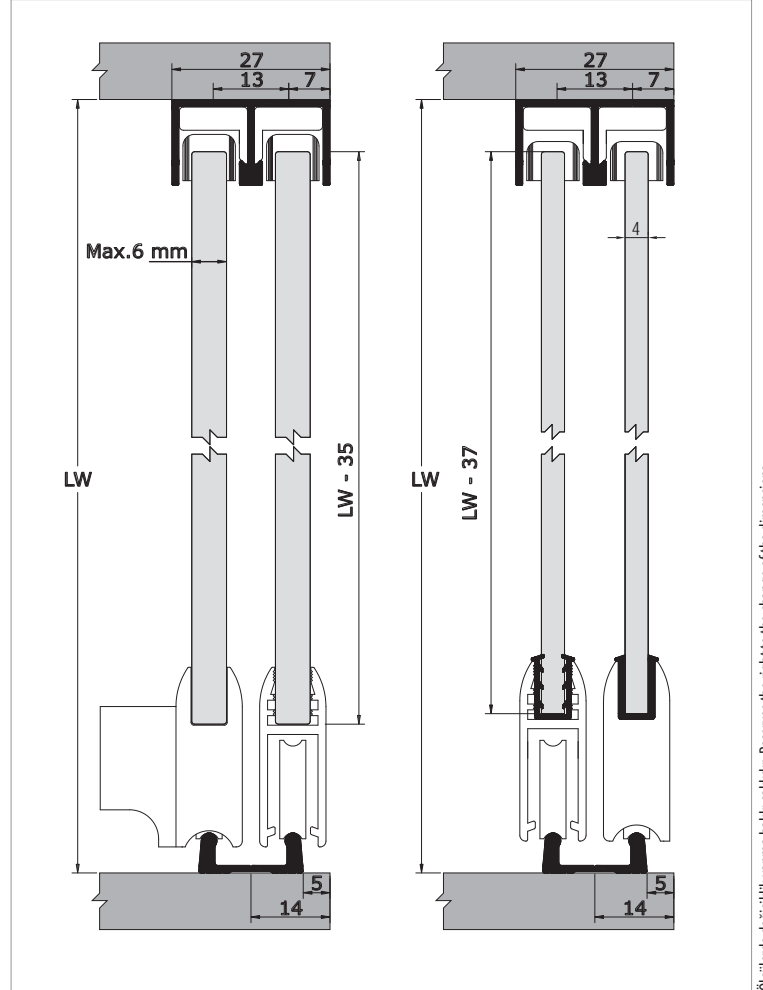

Ölçülerde değişiklik yapma hakkı saklıdır. Reserves the right to the change of the dimensions.

Kod / Code No	Açıklama / Description	Renk / Colour	Birim / Unit			Profil mt. / Profiles mt.	Bağ / Bnd.
108-7702-1600	Glassline 7702 - 25 Kg Sürme Cam Kapak Sistemi / 25 Kg Sliding Glass Door System	Gri / Grey	1 Kapak / 1 Kit	30	1.920	- - -	-
145-1015-1640	4 mm Cam Fitili / 4 mm Glass Wick	Şeffaf / Transparan	mt.	100	3.600	- - -	-
150-7715-1410	Alüminyum Üst Ray Profili / Aluminium Top Rail Profile	Eloksal / Mat Anodized	mt.	-	-	2,0 - 3,0	10 ad/pcs
150-7705-1410	Alüminyum Cam Tutucu / Aluminium Frame	Eloksal / Mat Anodized	mt.	-	-	2,0 - 3,0	10 ad/pcs
150-7710-1410	Alüminyum Alt Ray Profili / Aluminium Bottom Rail Profile	Eloksal / Mat Anodized	mt.	-	-	2,0 - 3,0	10 ad/pcs

Glassline 2

20 KG SÜRME YAVAŞLATICILI CAM KAPAK SİSTEMİ • SOFT CLOSING SLIDING GLASS DOOR SYSTEM

Yeni Ürün
New Product

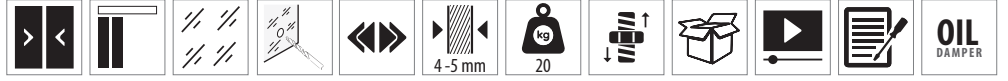
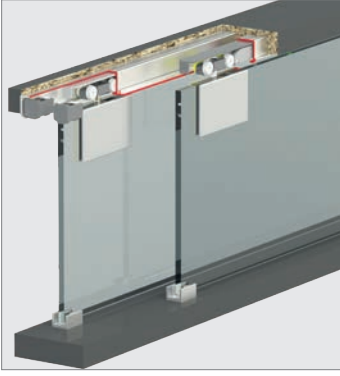

Yavaşlatıcı Alternatifi / Soft Closer Alternative

- Sistem üzerinde entegre yavaşlatıcı mevcuttur.
- The system has integrated soft closer.



Glassline 2 1 Takım İçeriği / 1 Kit Includes

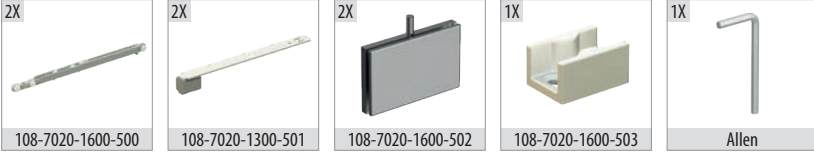

Ray Profilleri / Rail Profiles

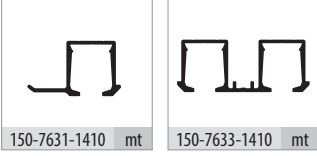

Teknik Detay / Technical Detail

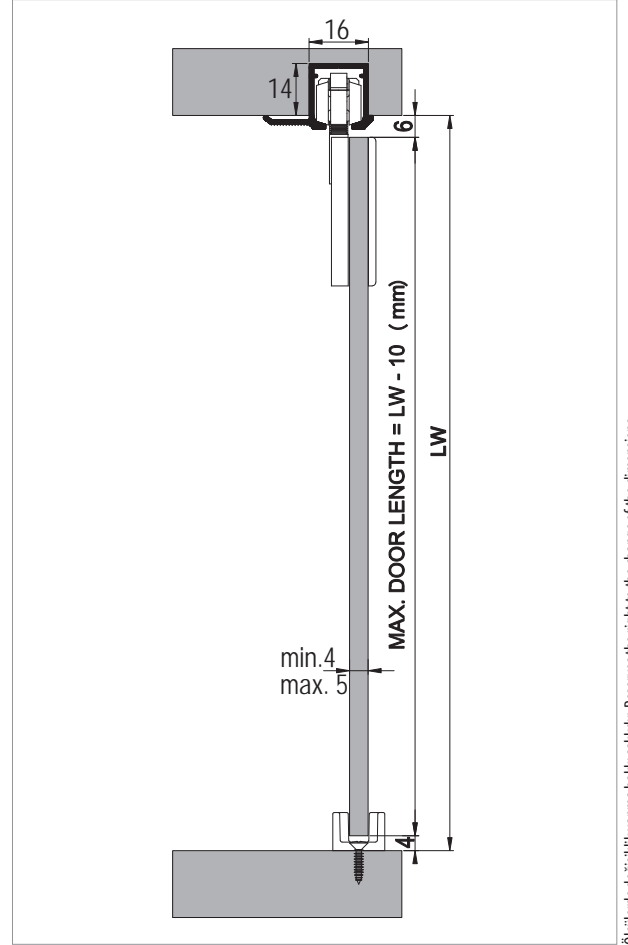

Ölçülerde değişiklik yapma hakkı saklıdır. Reserves the right to the change of the dimensions.

Kod / Code No	Açıklama / Description	Renk / Colour	Birim / Unit			Profil mt. / Profiles mt.	Bağ / Bnd.	
108-7020-1600	Glassline 2 - 20 Kg Sürme Cam Kapak Sistemi / 20 Kg Sliding Glass Door System	Gri / Grey	1 Kapak / 1 Kit	12	360	-	-	-
150-7631-1410	Alüminyum Üst Ray Profili / Aluminium Top Rail Profile	Eloksal / Mat Anodized	mt.	-	-	-	3,0	10 ad/pcs
150-7633-1410	Alüminyum Üst Ray Profili / Aluminium Top Rail Profile	Eloksal / Mat Anodized	mt.	-	-	-	3,0	10 ad/pcs

Softline Series

YAVAŞLATICI SİSTEM • SOFT CLOSER SYSTEM

Softline 6710 • 100 KG YAVAŞLATICI SİSTEM • SOFT CLOSERS SYSTEM

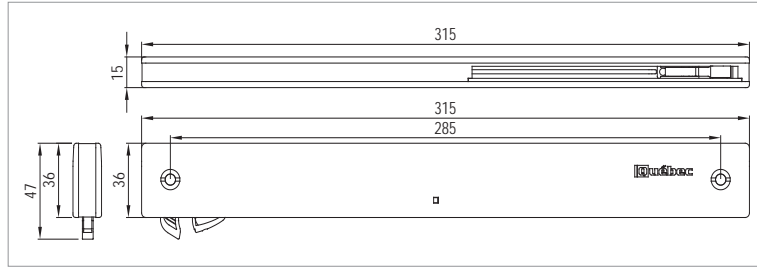

Kod / Code No	Açıklama / Description	Renk / Colour	Birim / Unit		
117-6710-1610	100 Kg Yavaşlatıcı Sistem / 100 Kg Soft Closer	Gri / Grey	1 Takım / 1 Kit	20	480

Softline 6711 • 100 KG YAVAŞLATICI SİSTEM • SOFT CLOSERS SYSTEM

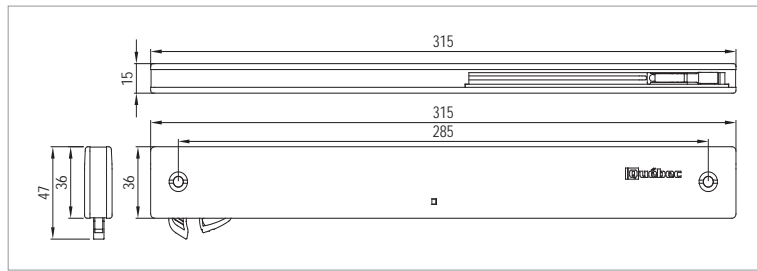

Kod / Code No	Açıklama / Description	Renk / Colour	Birim / Unit		
117-6711-1610	100 Kg Yavaşlatıcı Mekanizma / 100 Kg Soft Closer Mechanism	Gri / Grey	1 Takım / 1 Kit	24	576

Softline 6666 • 60 KG YAVAŞLATICI SİSTEM • SOFT CLOSERS SYSTEM

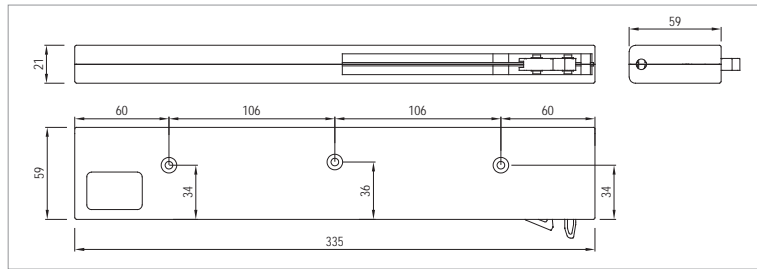

Kod / Code No	Açıklama / Description	Renk / Colour	Birim / Unit		
117-6666-1610	60 Kg Yavaşlatıcı Mekanizma / 60 Kg Soft Closer Mechanism	Gri / Grey	1 Takım / 1 Kit	30	360

Softline 6740 • 60 KG YAVAŞLATICI SİSTEM • SOFT CLOSERS SYSTEM

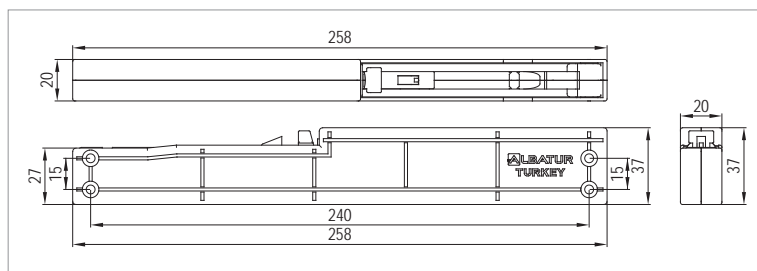

Kod / Code No	Açıklama / Description	Renk / Colour	Birim / Unit		
117-6740-1610	60 Kg Yavaşlatıcı Mekanizma / 60 Kg Soft Closer Mechanism	Gri / Grey	1 Adet / 1 Pcs.	60	1.250

Softline Series

YAVAŞLATICI SİSTEM • SOFT CLOSER SYSTEM

Softline 6940 • 40 KG YAVAŞLATICI SİSTEM • SOFT CLOSERS SYSTEM

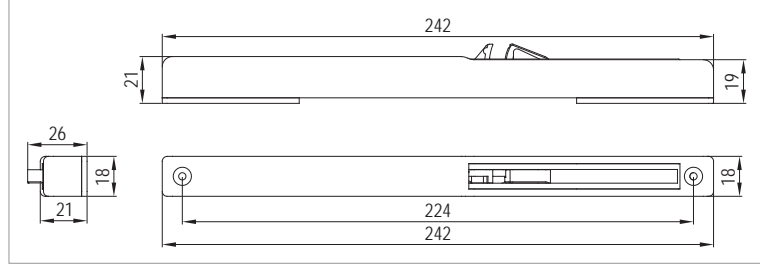
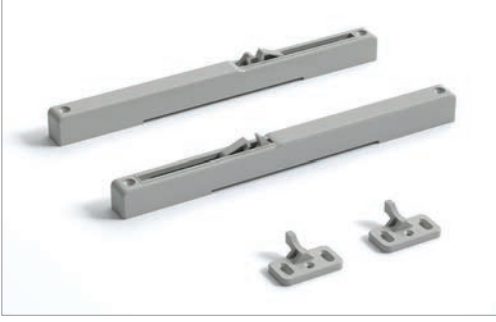

Kod / Code No	Açıklama / Description	Renk / Colour	Birim / Unit		
117-6940-1600	40 Kg Yavaşlatıcı Mekanizma / 40 Kg Soft Closer Mechanism	Gri / Grey	1 Takım / 1 Kit	50	1.250

Softline 6950 • 50 KG YAVAŞLATICI SİSTEM • SOFT CLOSERS SYSTEM

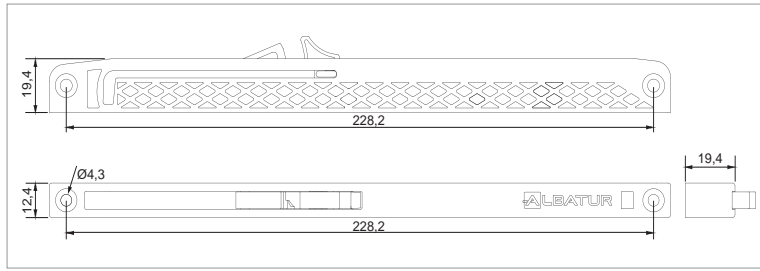

Kod / Code No	Açıklama / Description	Renk / Colour	Birim / Unit		
117-6950-1610	50 Kg Yavaşlatıcı Mekanizma / 50 Kg Soft Closer Mechanism	Gri / Grey	1 Takım / 1 Kit	50	1.250

Softline 6970 • 70 KG YAVAŞLATICI SİSTEM • SOFT CLOSERS SYSTEM

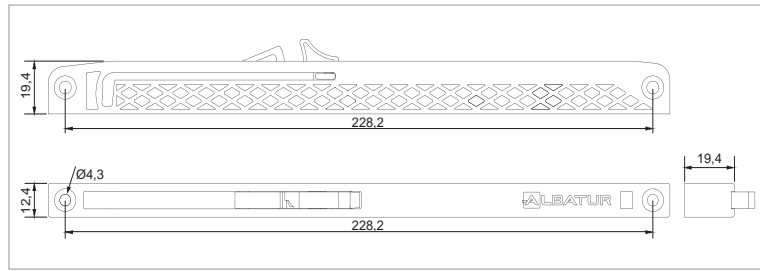

Kod / Code No	Açıklama / Description	Renk / Colour	Birim / Unit		
117-6970-1610	70 Kg Yavaşlatıcı Mekanizma / 70 Kg Soft Closer Mechanism	Gri / Grey	1 Takım / 1 Kit	50	1.250

Softline 6800 • 80 KG YAVAŞLATICI SİSTEM • SOFT CLOSERS SYSTEM

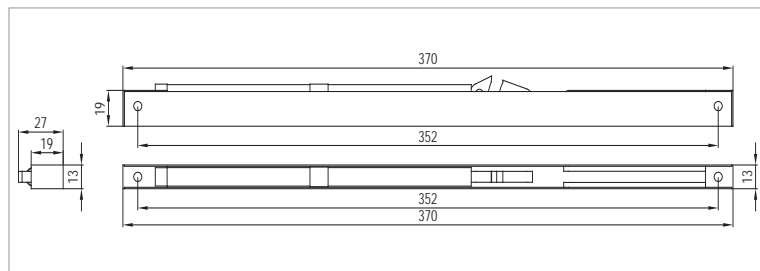

Kod / Code No	Açıklama / Description	Renk / Colour	Birim / Unit		
117-6800-1300	80 Kg Yavaşlatıcı Mekanizma / 80 Kg Soft Closer Mechanism	Galvaniz / Galvanized	1 Takım / 1 Kit	24	576

Softline Series

YAVAŞLATICI SİSTEM • SOFT CLOSER SYSTEM

Softline 6810 • 80 KG YAVAŞLATICI SİSTEM • SOFT CLOSERS SYSTEM

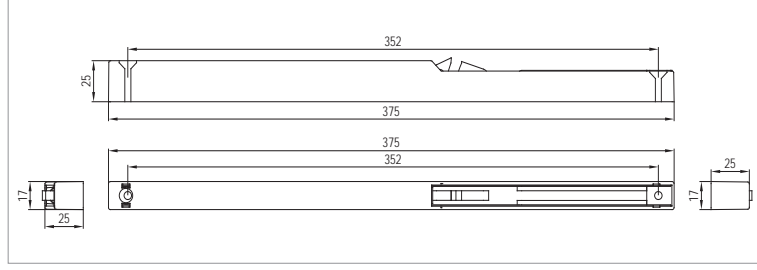

Kod / Code No	Açıklama / Description	Renk / Colour	Birim / Unit		
117-6810-1600	80 Kg Yavaşlatıcı Mekanizma / 80 Kg Soft Closer Mechanism	Gri / Grey	1 Takım / 1 Kit	24	576

Softline 6942 • 50 KG YAVAŞLATICI SİSTEM • SOFT CLOSERS SYSTEM

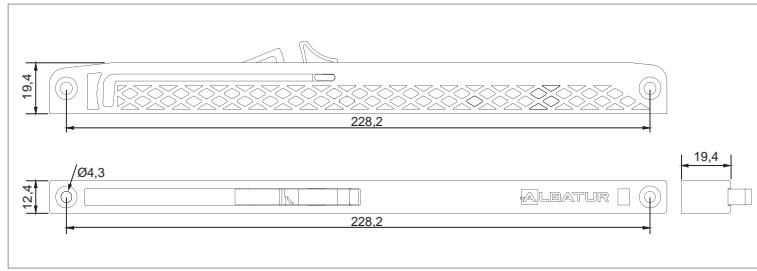
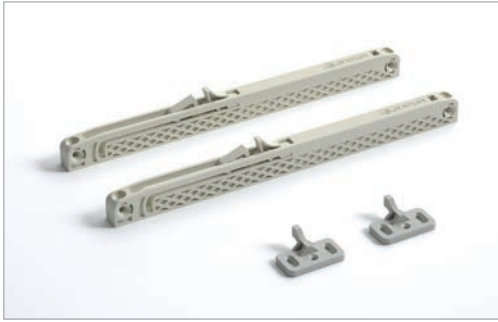

Kod / Code No	Açıklama / Description	Renk / Colour	Birim / Unit		
117-6942-1610	50 Kg Yavaşlatıcı Mekanizma / 50 Kg Soft Closer Mechanism	Gri / Grey	1 Takım / 1 Kit	50	1.250

Softline 6901 • 50 KG YAVAŞLATICI SİSTEM • SOFT CLOSERS SYSTEM

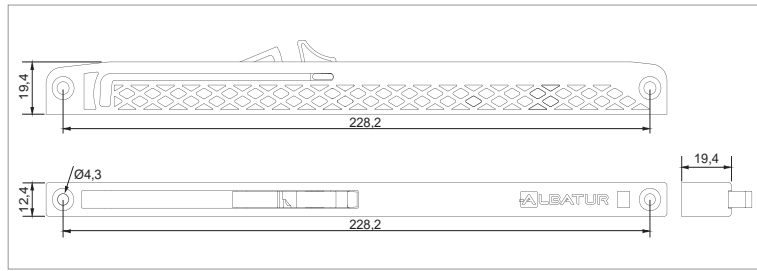

Kod / Code No	Açıklama / Description	Renk / Colour	Birim / Unit		
117-6901-1610	50 Kg Yavaşlatıcı Mekanizma / 50 Kg Soft Closer Mechanism	Gri / Grey	1 Takım / 1 Kit	50	1.250

Softline 6990 • 80 KG YAVAŞLATICI SİSTEM • SOFT CLOSERS SYSTEM

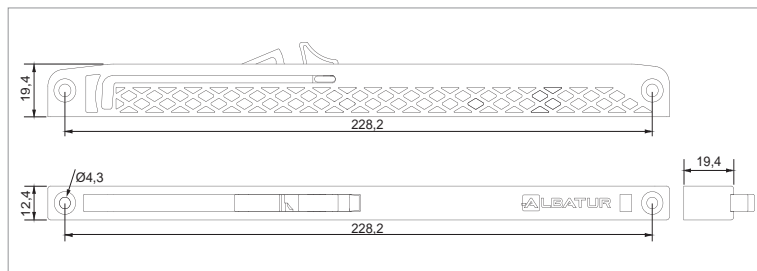

Kod / Code No	Açıklama / Description	Renk / Colour	Birim / Unit		
117-6990-1610	80 Kg Yavaşlatıcı Mekanizma / 80 Kg Soft Closer Mechanism	Gri / Grey	1 Takım / 1 Kit	50	1.250

Softline Series

YAVAŞLATICI SİSTEM • SOFT CLOSER SYSTEM

Softline 6700 • 80 KG YAVAŞLATICI SİSTEM • SOFT CLOSERS SYSTEM

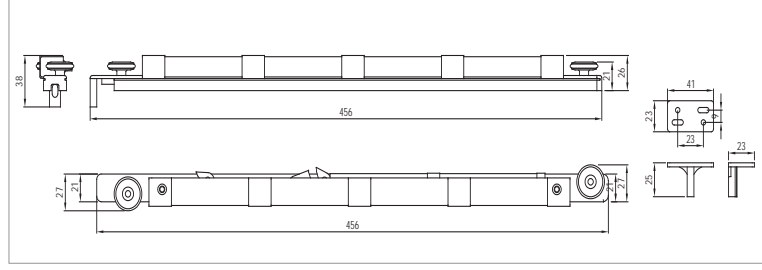

Kod / Code No	Açıklama / Description	Renk / Colour	Birim / Unit		
117-6700-1600	80 Kg Yavaşlatıcı Mekanizma / 80 Kg Soft Closer Mechanism	Gri / Grey	1 Takım / 1 Kit	24	576

Softline 6922 • 50 KG YAVAŞLATICI SİSTEM • SOFT CLOSERS SYSTEM

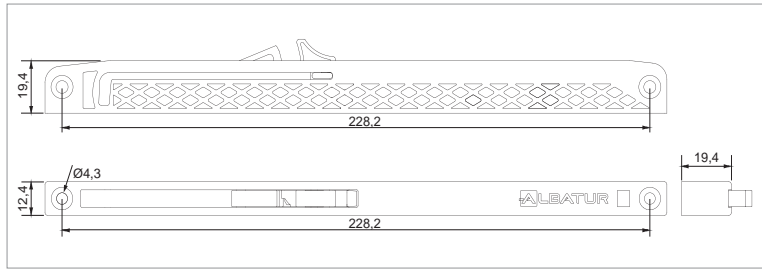
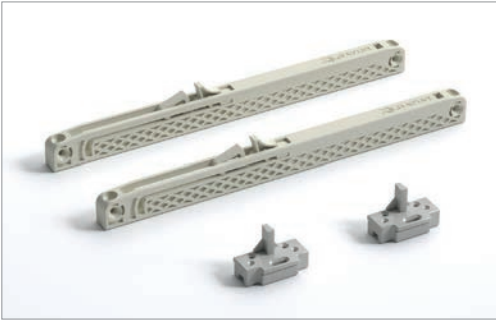

Kod / Code No	Açıklama / Description	Renk / Colour	Birim / Unit		
117-6922-1610	50 Kg Yavaşlatıcı Mekanizma / 50 Kg Soft Closer Mechanism	Gri / Grey	1 Takım / 1 Kit	50	1.250

Softline 6921 • 70 KG YAVAŞLATICI SİSTEM • SOFT CLOSERS SYSTEM

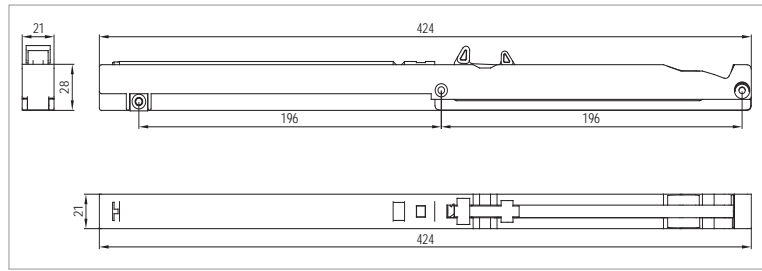

Kod / Code No	Açıklama / Description	Renk / Colour	Birim / Unit		
117-6921-1600	70 Kg Yavaşlatıcı Mekanizma / 60 Kg Soft Closer Mechanism	Gri / Grey	1 Takım / 1 Kit	24	1.200

Softline 6959 • 50 KG YAVAŞLATICI SİSTEM • SOFT CLOSERS SYSTEM

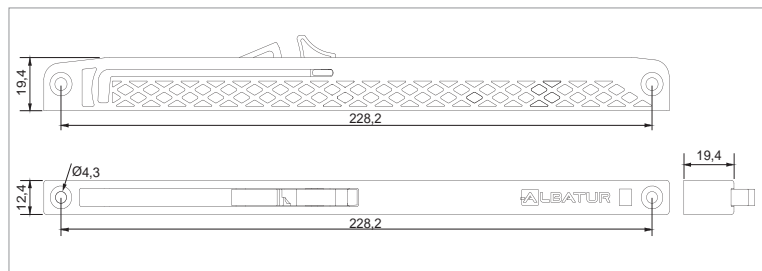
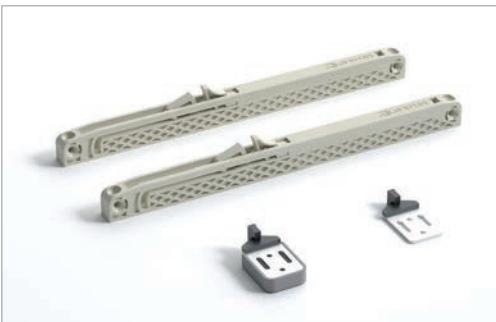

Kod / Code No	Açıklama / Description	Renk / Colour	Birim / Unit		
117-6959-1610	50 Kg Yavaşlatıcı Mekanizma / 50 Kg Soft Closer Mechanism	Gri / Grey	1 Takım / 1 Kit	50	1.250

Pulltens

ÇEK-GER SERİSİ • PULL & TENSION SERIES

Pulltens 1



Bilgi / Information

- Birim adet fiyatlandırır.
- 40 cm'den geniş kapaklarda 2 adet kullanımı önerilir.
- Özel ölçü için müşteri temsilciniz ile görüşünüz.
- Maksimum kapak yüksekliği 2.200 mm tavsiye edilir.
- Minimum kapak yüksekliği 1.700 mm tavsiye edilir.

- Unit Prices
- More than 40 cm width doors, recommended to use 2 pcs
- For special size please contact customer representative.
- Maximum door height is 2.200 mm recommended.
- Minimum door height is 1.700 mm recommended.



Kod / Code No	Açıklama / Description	Renk / Colour	Birim / Unit		
118-0001-1600	CG 01 - Metal Başlı Çek-Ger Mekanizması - Pull & Tension Equipments - Metal	Galvaniz / Galvanized	1 Adet / 1 Pcs	24	384

Pulltens 2



Bilgi / Information

- Birim adet fiyatlandırır.
- 40 cm'den geniş kapaklarda 2 adet kullanımı önerilir.
- Özel ölçü için müşteri temsilciniz ile görüşünüz.
- Maksimum kapak yüksekliği 2.200 mm tavsiye edilir.
- Minimum kapak yüksekliği 1.800 mm tavsiye edilir.

- Unit Prices
- More than 40 cm width doors, recommended to use 2 pcs
- For special size please contact customer representative.
- Maximum door height is 2.200 mm recommended.
- Minimum door height is 1.800 mm recommended.



Kod / Code No	Açıklama / Description	Renk / Colour	Birim / Unit		
118-0002-1600	CG 02 - Metal Başlı Boy Çek-Ger Mekanizması - Pull & Tension Equipments - Metal	Galvaniz / Galvanized	1 Adet / 1 Pcs	30	360

Pulltens 5



Bilgi / Information

- Birim adet fiyatlandırır.
- 40 cm'den geniş kapaklarda 2 adet kullanımı önerilir.
- Özel ölçü için müşteri temsilciniz ile görüşünüz.
- Maksimum kapak yüksekliği 2.200 mm tavsiye edilir.
- Minimum kapak yüksekliği 1.700 mm tavsiye edilir.

- Unit Prices
- More than 40 cm width doors, recommended to use 2 pcs
- For special size please contact customer representative.
- Maximum door height is 2.200 mm recommended.
- Minimum door height is 1.700 mm recommended.



Kod / Code No	Açıklama / Description	Renk / Colour	Birim / Unit		
118-0005-1600	CG 05 - Plastik Başlı Çek-Ger Mekanizması - Pull & Tension Equipments - Plastic	Galvaniz / Galvanized	1 Adet / 1 Pcs	24	384

Pulltens 6



Bilgi / Information

- Birim adet fiyatlandırır.
- 40 cm'den geniş kapaklarda 2 adet kullanımı önerilir.
- 3.000 mm kadar özel üretim yapılabilir.
- Maksimum kapak yüksekliği 2.300 mm tavsiye edilir.
- Minimum kapak yüksekliği 800 mm tavsiye edilir.

- Unit Prices
- More than 40 cm width doors, recommended to use 2 pcs
- Special production can be made up to 3.000 mm.
- For special size please contact customer representative.
- Maximum door height is 2.300 mm recommended.
- Minimum door height is 800 mm recommended.



Kod / Code No	Açıklama / Description	Renk / Colour	Birim / Unit		
118-0006-1400	Alüminyum Çek-Ger Mekanizması - Pull & Tension Equipments - Aluminium	Pres / Uncoated	1 Adet / 1 Pcs	30	360

Pulltens

ÇEK-GER SERİSİ • PULL & TENSION SERIES

Pulltens 7



Bilgi / Information

- Birim adet fiyatlandır.
 - 40 cm'den geniş kapaklarda 2 adet kullanımı önerilir.
 - 3.000 mm kadar özel üretim yapılabilir.
 - Maksimum kapak yüksekliği 2.300 mm tavsiye edilir.
 - Minimum kapak yüksekliği 800 mm tavsiye edilir.
- Unit Prices
- More than 40 cm width doors, recommended to use 2 pcs
 - Special production can be made up to 3.000 mm.
 - For special size please contact customer representative.
 - Maximum door height is 2.300 mm recommended.
 - Minimum door height is 800 mm recommended.



Kod / Code No	Açıklama / Description	Renk / Colour	Birim / Unit		
118-0007-1400	Zamak Başlı Alüminyum Çek-Ger Mekanizması - Pull & Tension Equipment Alm.	Pres / Uncoated	1 Adet / 1 Pcs	30	360

Pulltens 9



Bilgi / Information

- Birim adet fiyatlandır.
 - 40 cm'den geniş kapaklarda 2 adet kullanımı önerilir.
 - Minimum 1.600 - Maksimum 2.500 mm kadar özel üretim yapılabilir.
 - Maksimum kapak yüksekliği 2.200 mm tavsiye edilir.
 - Minimum kapak yüksekliği 2.000 mm tavsiye edilir.
- Unit Prices
- More than 40 cm width doors, recommended to use 2 pcs
 - From Minimum 1.600 mm up to Maximum 2.500 mm can be made special production
 - For special size please contact customer representative.
 - Maximum door height is 2.200 mm recommended.
 - Minimum door height is 2.000 mm recommended.



Kod / Code No	Açıklama / Description	Renk / Colour	Birim / Unit		
118-0009-1400	Alüminyum Boy Gergi Mekanizması - Aluminium Tension Mechanism	Eloksal / Mat Anodized	1 Adet / 1 Pcs	30	360

Pulltens 11



Bilgi / Information

- Birim adet fiyatlandır.
 - 40 cm'den geniş kapaklarda 2 adet kullanımı önerilir.
 - Özel ölçü için müşteri temsilciniz ile görüşünüz.
 - Maksimum kapak yüksekliği 2.200 mm tavsiye edilir.
 - Minimum kapak yüksekliği 1.950 mm tavsiye edilir.
- Unit Prices
- More than 40 cm width doors, recommended to use 2 pcs
 - For special size please contact customer representative.
 - Maximum door height is 2.200 mm recommended.
 - Minimum door height is 1.950 mm recommended.



Kod / Code No	Açıklama / Description	Renk / Colour	Birim / Unit		
118-0011-1600	Zamak Başlı Alüminyum Çek-Ger Mekanizması - Pull & Tension Equipment Alm.	Galvaniz /Galvanized	1 Adet / 1 Pcs	30	360

Pulltens 12



Bilgi / Information

- Birim adet fiyatlandır.
 - 40 cm'den geniş kapaklarda 2 adet kullanımı önerilir.
 - Özel ölçü için müşteri temsilciniz ile görüşünüz.
 - Maksimum kapak yüksekliği 2.200 mm tavsiye edilir.
 - Minimum kapak yüksekliği 1.950 mm tavsiye edilir.
- Unit Prices
- More than 40 cm width doors, recommended to use 2 pcs
 - For special size please contact customer representative.
 - Maximum door height is 2.200 mm recommended.
 - Minimum door height is 1.950 mm recommended.



Kod / Code No	Açıklama / Description	Renk / Colour	Birim / Unit		
118-0012-1600	Zamak Başlı Alüminyum Çek-Ger Mekanizması - Pull & Tension Equipment Alm.	Galvaniz /Galvanized	1 Adet / 1 Pcs	30	360

BarnDoor 8800

ÜSTTEN ASKI AHŞAP SÜRME KAPI SİSTEMİ • TOP HANGER WOODEN SLIDING DOOR SYSTEM



Bilgi / Information

- 2.300 - 2.600 - 2.900 - 3.200 - 3.500 mm özel boylar yapılmakta olup, her bir ürün 200 mm'ye kadar kısaltma yapılabilir.
- Special sizes Can be made 2.300 - 2.600 - 2.900 - 3.200 - 3.500 mm each product can be shortened up to 200 mm.



BarnDoor 8800 1 Takım İçeriği / 1 Kit Includes



Teknik Detay / Technical Detail

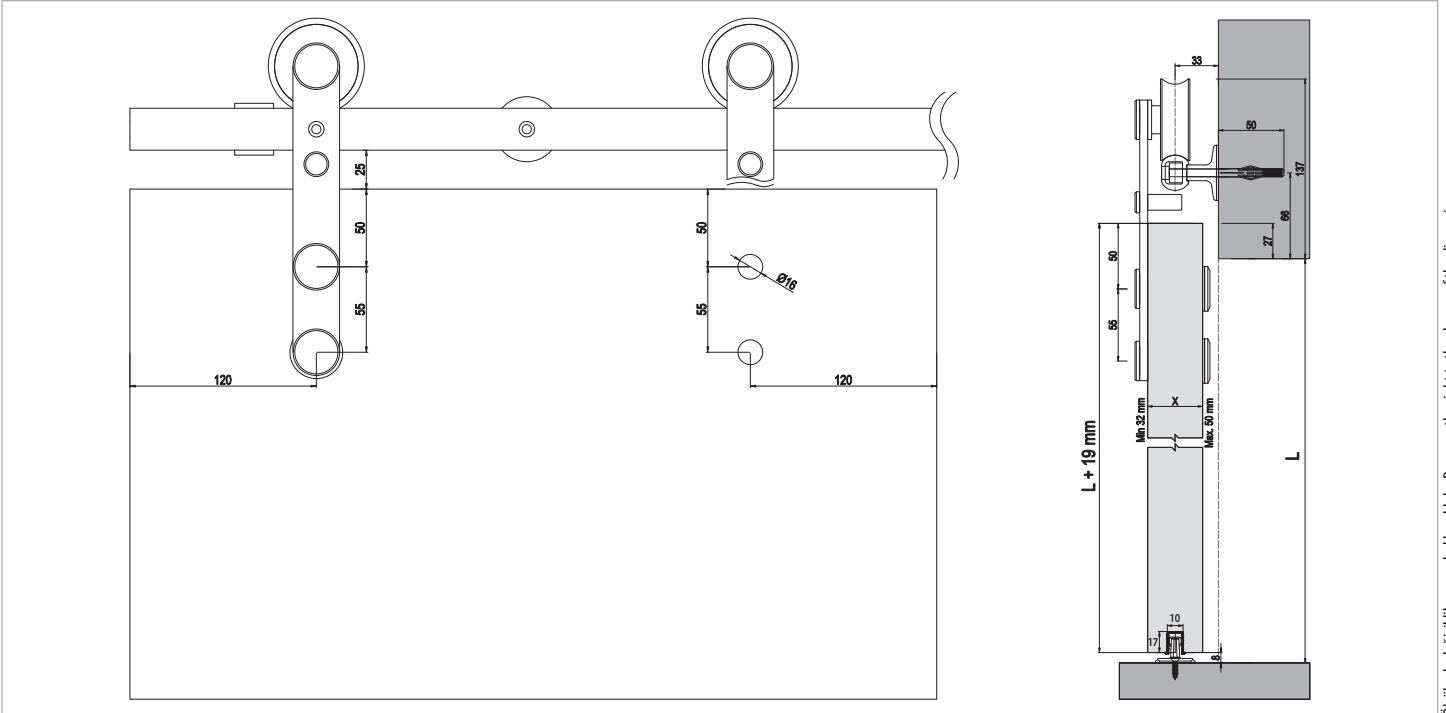

Ölçülerde değişiklik yapma hakkı saklıdır. Reserves the right to the change of the dimensions.

Uygulama / Application



SETBOX Paketleme / SETBOX Packaging

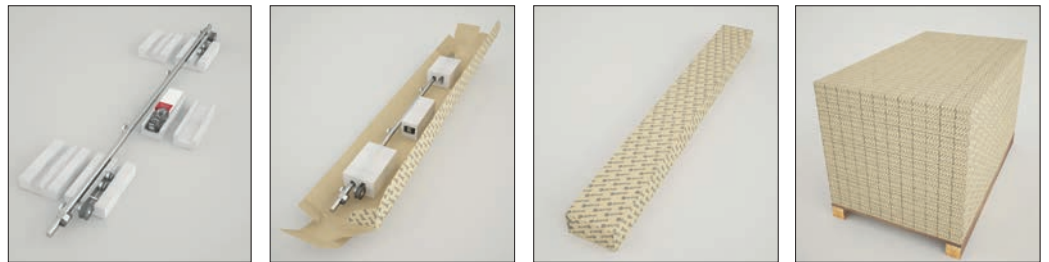

Kod / Code No	Açıklama / Description	Renk / Colour	L (mm)	Birim / Unit		
119-8800-3430-1700	Üstten Askı Sürme Kapi Sistemi / Top Hanger Sliding System	Siyah / Black	1.700 mm	1 Kapi / 1 Kit	1	30
119-8800-3430-2000	Üstten Askı Sürme Kapi Sistemi / Top Hanger Sliding System	Siyah / Black	2.000 mm	1 Kapi / 1 Kit	1	30

BarnDoor 8820

80 KG ÇİFT YÖNE YAVAŞLATICILI SÜRME KAPI SİSTEMİ • SLIDING DOOR SYSTEM - TWO WAY SOFT CLOSING



Bilgi / Information

- 2.500 - 3.000 - 3.500 - 4.000 mm özel boylar yapılmakta olup, özel boy ürünler 500 mm'ye kadar kısaltma yapılabilir.
- Special sizes Can be made 2.500 - 3.000 - 3.500 - 4.000 mm can be shortened up to 500 mm for special sizes.

Yavaşlatıcı Alternatifi / Soft Closer Alternative

- Sistem üzerinde entegre yavaşlatıcı mevcuttur.
- The system has integrated soft closer.



BarnDoor 8820 1 Takım İçeriği / 1 Kit Includes



Teknik Detay / Technical Detail

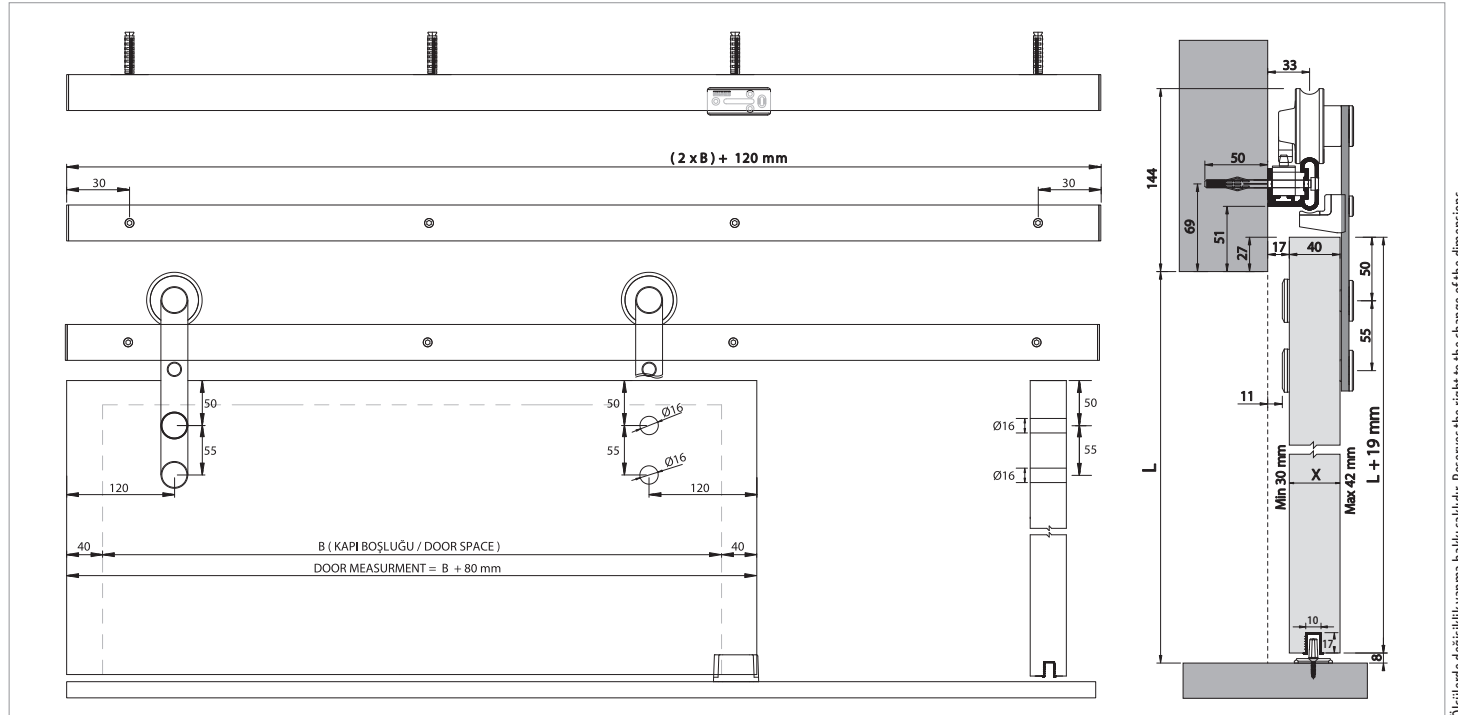

Ölçülerde değişiklik yapma hakkı saklıdır. Reserves the right to the change of the dimensions.

Uygulama / Application



SETBOX Paketleme / SETBOX Packaging

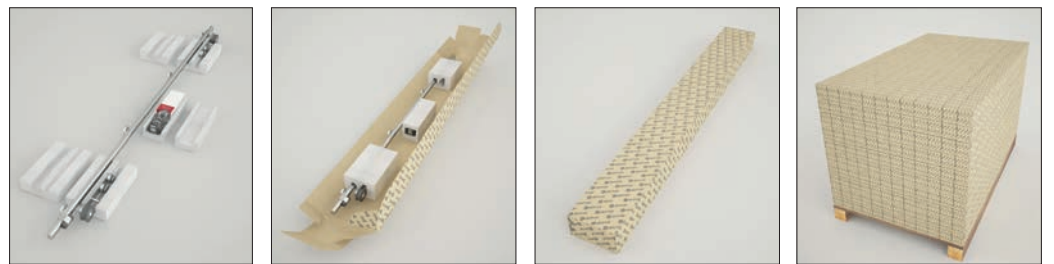

Kod / Code No	Açıklama / Description	Renk / Colour	L (mm)	Birim / Unit		
119-8820-3430-1700	80 Kg Yavaşlatıcılı Sürgü Kapi Sistemi / Sliding Door Has Soft Closing System	Siyah / Black	1.700 mm	1 Kapi / 1 Kit	1	30
119-8820-3430-2000	80 Kg Yavaşlatıcılı Sürgü Kapi Sistemi / Sliding Door Has Soft Closing System	Siyah / Black	2.000 mm	1 Kapi / 1 Kit	1	30

BarnDoor 8900

ÜSTTEN ASKI CAM SÜRME KAPI SİSTEMİ • TOP HANGER GLASS SLIDING DOOR SYSTEM



Bilgi / Information

- 2.300 - 2.600 - 2.900 - 3.200 - 3.500 mm özel boylar yapılmakta olup, her bir ürün 200 mm'ye kadar kısaltma yapılabilir.
- Special sizes Can be made 2.300 - 2.600 - 2.900 - 3.200 - 3.500 mm each product can be shortened up to 200 mm.



BarnDoor 8900 1 Takım İçeriği / 1 Kit Includes



Teknik Detay / Technical Detail

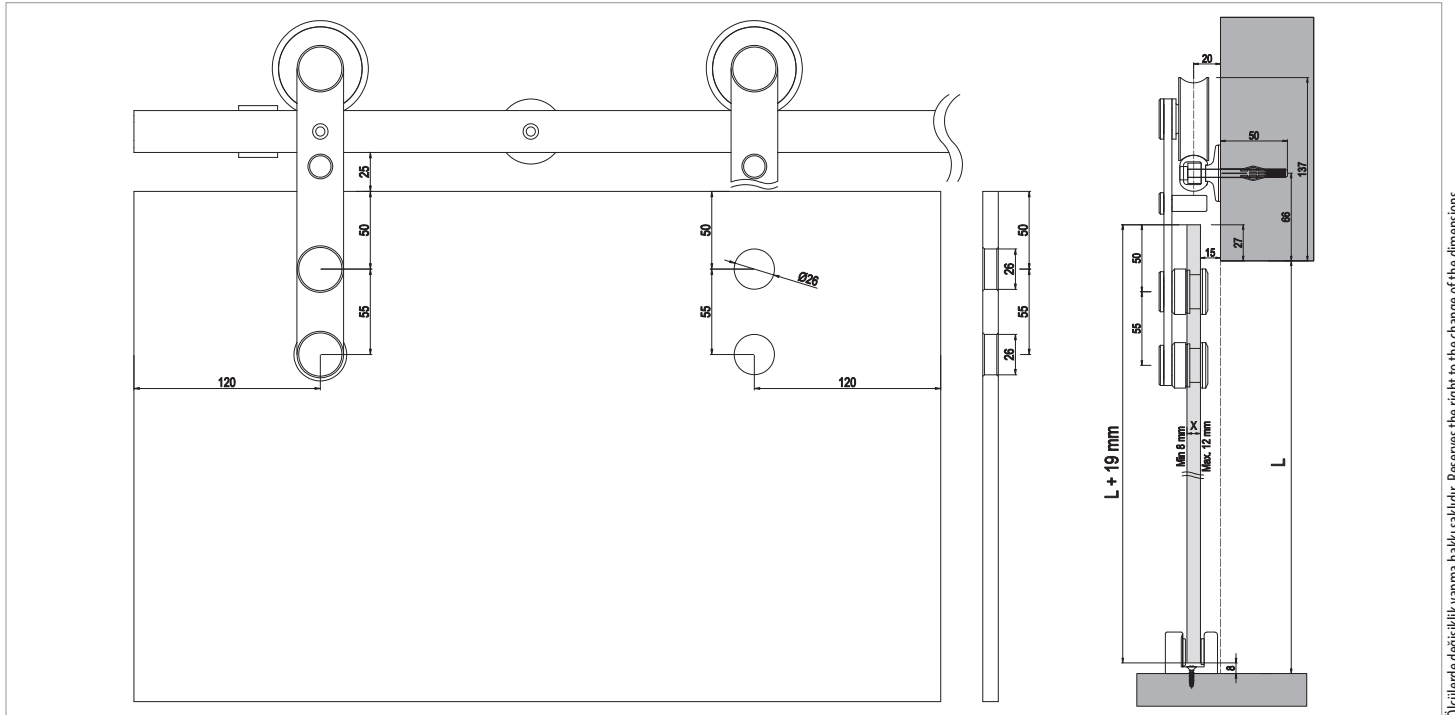



Ölçülerde değişiklik yapma hakkı saklıdır. Reserves the right to the change of the dimensions.

Uygulama / Application

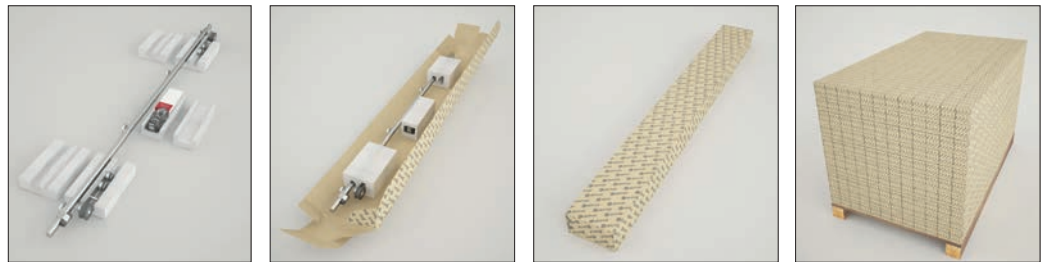

SETBOX Paketleme / SETBOX Packaging



Kod / Code No	Açıklama / Description	Renk / Colour	L (mm)	Birim / Unit		
119-8900-3410-1700	Üstten Askı Cam Sürme Kapı Sistemi / Top Hanger Glass Sliding Door System	Gri / Grey	1.700 mm	1 Kapı / 1 Kit	1	30
119-8900-3410-2000	Üstten Askı Cam Sürme Kapı Sistemi / Top Hanger Glass Sliding Door System	Gri / Grey	2.000 mm	1 Kapı / 1 Kit	1	30

BarnDoor 8920

80 KG ÇİFT YÖNE YAVAŞLATICILI SÜRME CAM KAPI SİSTEMİ • SLIDING GLASS DOOR SYSTEM - TWO WAY SOFT CLOSING



Bilgi / Information

- 2.500 - 3.000 - 3.500 - 4.000 mm özel boylar yapılmakta olup, özel boy ürünler 500 mm'ye kadar kısaltma yapılabilir.
- Special sizes Can be made 2.500 - 3.000 - 3.500 - 4.000 mm can be shortened up to 500 mm for special sizes.

Yavaşlatıcı Alternatifi / Soft Closer Alternative

- Sistem üzerinde entegre yavaşlatıcı mevcuttur.
- The system has integrated soft closer.



BarnDoor 8920 1 Takım İçeriği / 1 Kit Includes



Teknik Detay / Technical Detail

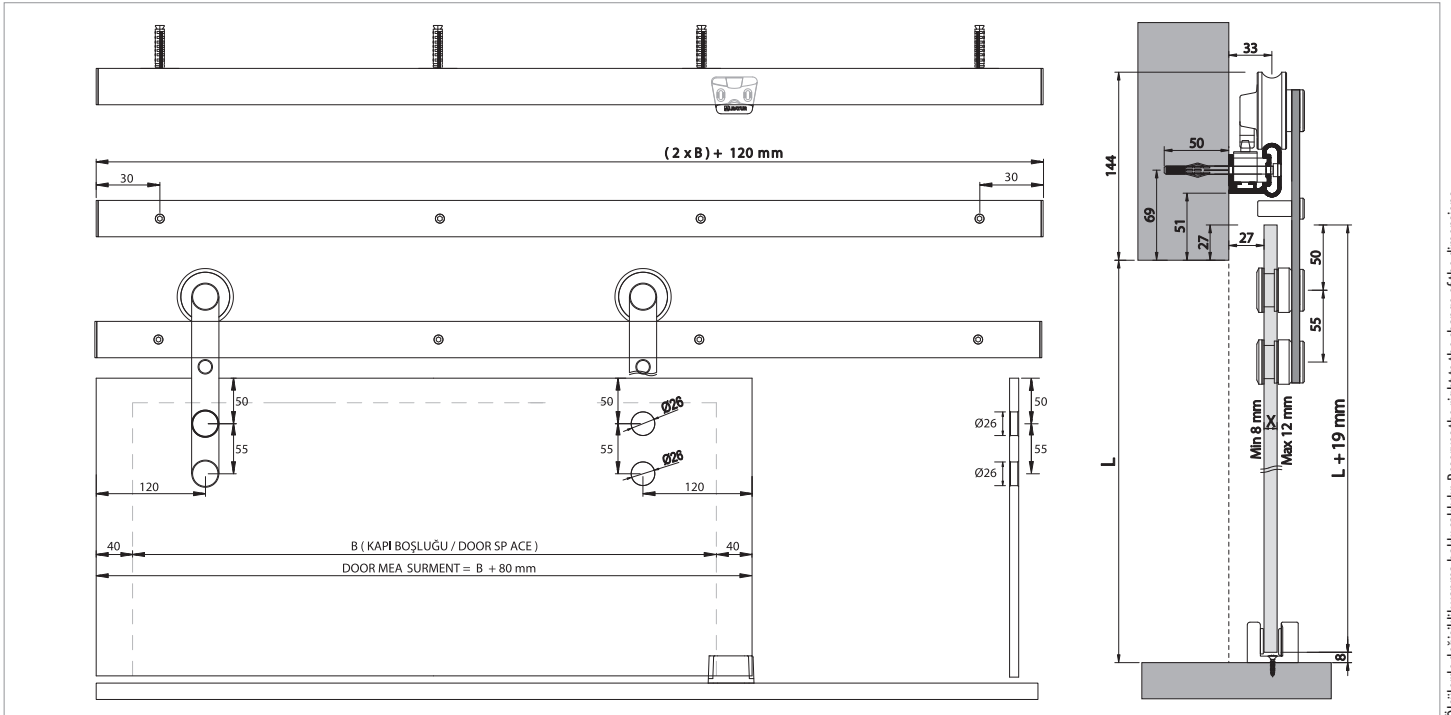

Ölçülerde değişiklik yapma hakkı saklıdır. Reserves the right to the change of the dimensions.

Uygulama / Application



SETBOX Paketleme / SETBOX Packaging

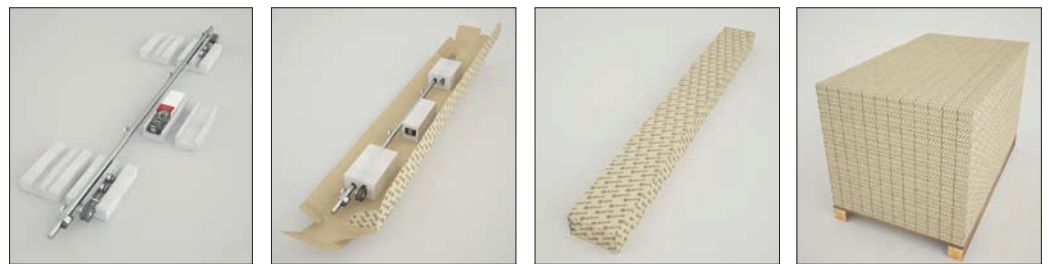

Kod / Code No	Açıklama / Description	Renk / Colour	L (mm)	Birim / Unit		
119-8920-3430-1700	Yavaşlatıcılı Sürme Cam Kapi Sistemi / Glass Sliding Door System (Soft Closing)	Siyah / Black	1.700 mm	1 Kapi / 1 Kit	1	30
119-8920-3430-2000	Yavaşlatıcılı Sürme Cam Kapi Sistemi / Glass Sliding Door System (Soft Closing)	Siyah / Black	2.000 mm	1 Kapi / 1 Kit	1	30



DoorSlide 9010

SÜRME KAPI SİSTEMİ • SLIDING DOOR SYSTEM

albaturas.com



MultiDoor 450

TELESKOPİK SÜRME KAPI SİSTEMİ • SOFTLINE TELESCOPIC SLIDING DOOR SYSTEM

albaturas.com

DoorSlide 9010

60 KG AY. ÇİFT YÖNE YAVAŞLATICILI SÜRME KAPI SİSTEMİ • SLIDING DOOR SYSTEM - TWO WAY SOFT CLOSING

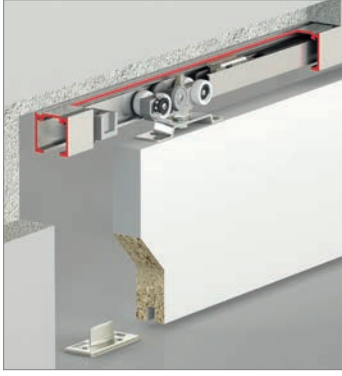

Bilgi / Information

- Minimum kapı genişliği 650 mm olmalıdır.
- Min. Door width 650 mm

Yavaşlatıcı Alternatifi / Soft Closer Alternative

- Sistem üzerinde çift yöne yavaşlatıcı mevcuttur.
- The system has two way soft closing.



9010 1 Takım İçeriği / 1 Kit Includes

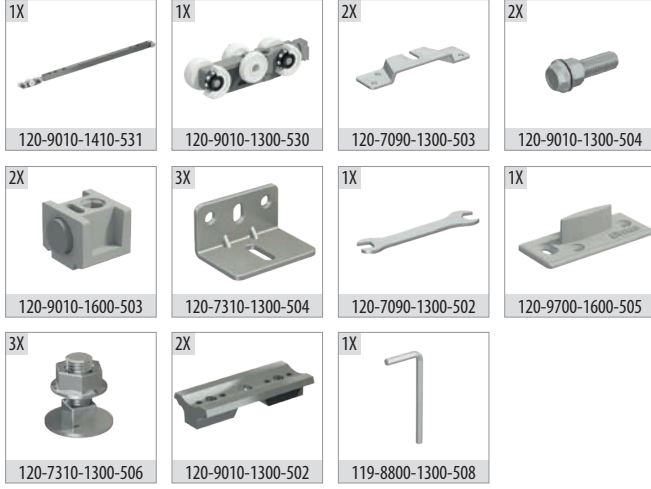

Ray Profilleri / Rail Profiles

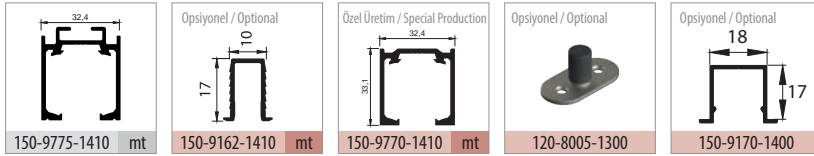

Uygulama / Application



* Duvar içi uygulamalarda, mekanizmanın hareketli teker bloğu sayesinde ray içi montajını kolaylaştırmaktadır.

* In wall Mounting application, its easy to fix in-rail installation through to movable roller block.

Teknik Detay / Technical Detail

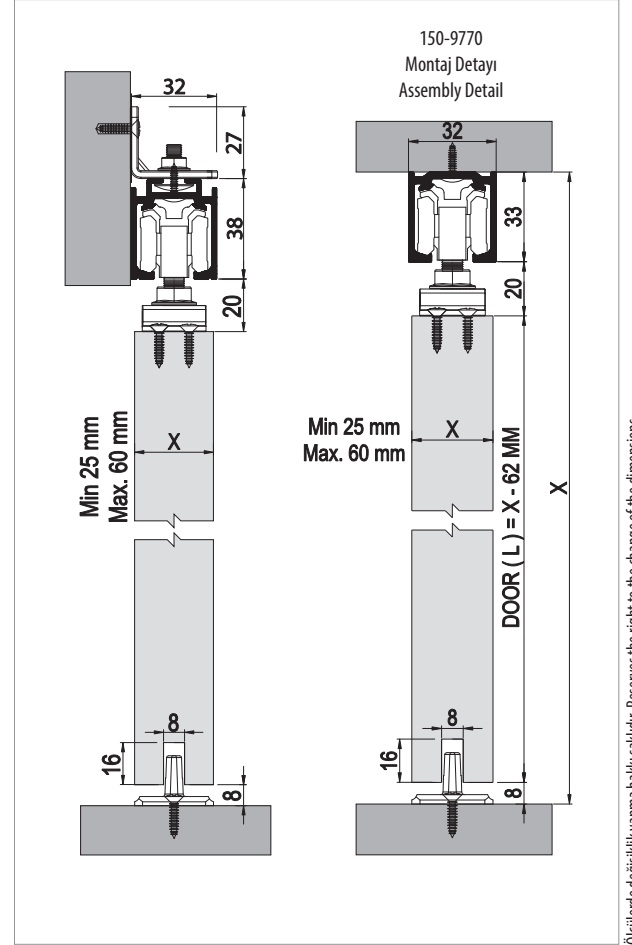

Kod / Code No	Açıklama / Description	Renk / Colour	Birim / Unit			Profil mt. / Profiles mt.	Bağ / Bnd.	
120-9010-1410	9010 SFT - 60 Kg Yavaş Sürme Kapı Sistemi / Sliding Door System - Soft Closing	Gri / Grey	1 Kapı / 1 Kit	12	576	-	-	
150-9775-1410	Alüminyum Üst Ray Profili / Aluminium Top Rail Profile	Eloksal / Mat Anodized	mt.	-	-	2,0	3,0	6 ad/pcs
150-9162-1410	Alüminyum Alt Klavuz Profili / Aluminium Bottom Slider Profile	Eloksal / Mat Anodized	mt.	-	-		3,0	20 ad/pcs

DoorSlide 9015

60 KG AY. ÇİFT YÖNE YAVAŞLATICILI SÜRME KAPI SİSTEMİ • SLIDING DOOR SYSTEM - TWO WAY SOFT CLOSING



Bilgi / Information

- Minimum kapı genişliği 650 mm olmalıdır.
- Min. Door width 650 mm

Yavaşlatıcı Alternatifi / Soft Closer Alternative

- Sistem üzerinde çift yöne yavaşlatıcı mevcuttur.
- The system has two way soft closing.



9015 1 Takım İçeriği / 1 Kit Includes



Ray Profilleri / Rail Profiles

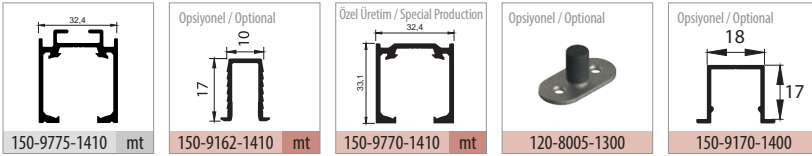

Uygulama / Application



* Duvar içi uygulamalarda, mekanizmanın hareketli teker bloğu sayesinde ray içi montajını kolaylaştırmaktadır.

* In wall Mounting application, its easy to fix in-rail installation through to movable roller block.

Teknik Detay / Technical Detail

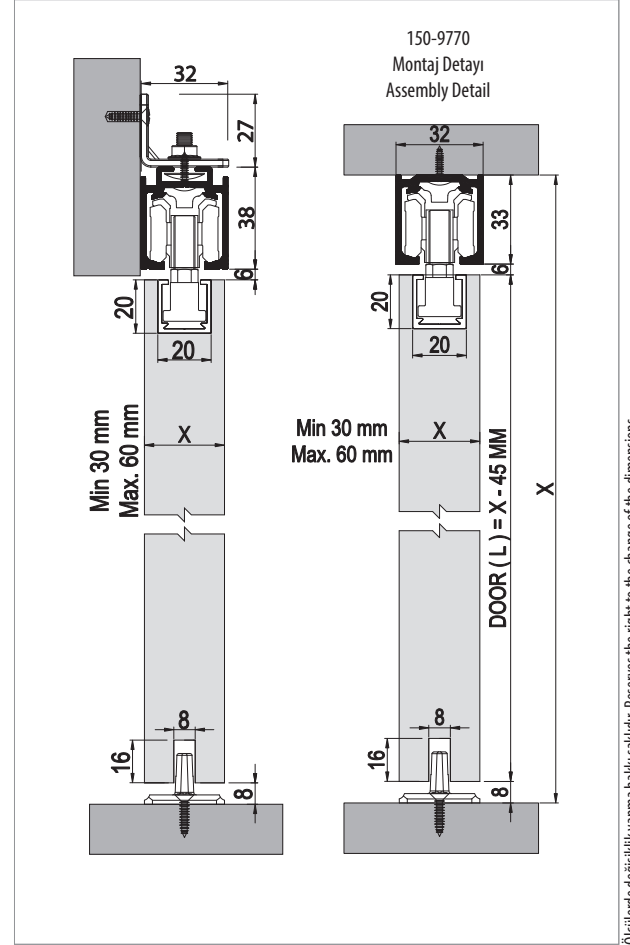

Ölçülerde değişiklik yapma hakkı saklıdır. Reserves the right to the change of the dimensions.

Kod / Code No	Açıklama / Description	Renk / Colour	Birim / Unit			Profil mt. / Profiles mt.	Bağ / Bnd.
120-9015-1410	60 Kg Yavaşlatıcı Sürme Kapı Sistemi / Sliding Door System - Two Way Soft Closing	Gri / Grey	1 Kapı / 1 Kit	12	360	- - -	-
150-9775-1410	Alüminyum Üst Ray Profili / Aluminium Top Rail Profile	Eloksal / Mat Anodized	mt.	-	-	2,0 - 3,0	6 ad/pcs
150-9162-1410	Alüminyum Alt Klavuz Profili / Aluminium Bottom Slider Profile	Eloksal / Mat Anodized	mt.	-	-	- 3,0	20 ad/pcs

DoorSlide 9701

120 KG TEK YÖNE YAVAŞLATICILI SÜRGÜ KAPI SİSTEMİ • SLIDING DOOR SYSTEM - HAS SOFT CLOSING

9700 SFT



Bilgi / Information

- Minimum kapı genişliği 500 mm olmalıdır.
- Min. Door width 500 mm

Yavaşlatıcı Alternatifi / Soft Closer Alternative

- Sistem üzerinde tek yöne yavaşlatıcı mevcuttur.
- The system has one way soft closing.



9701 1 Takım İçeriği / 1 Kit Includes

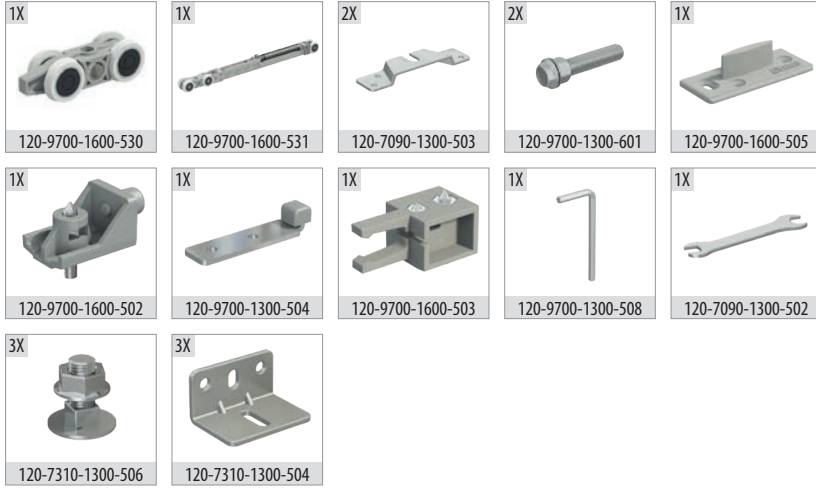

Ray Profilleri / Rail Profiles

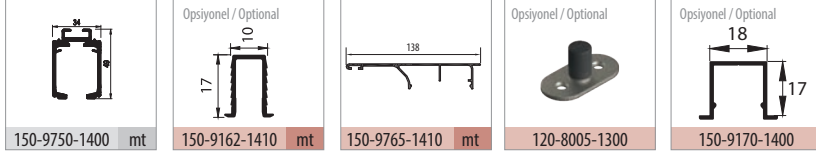

Uygulama / Application



Teknik Detay / Technical Detail

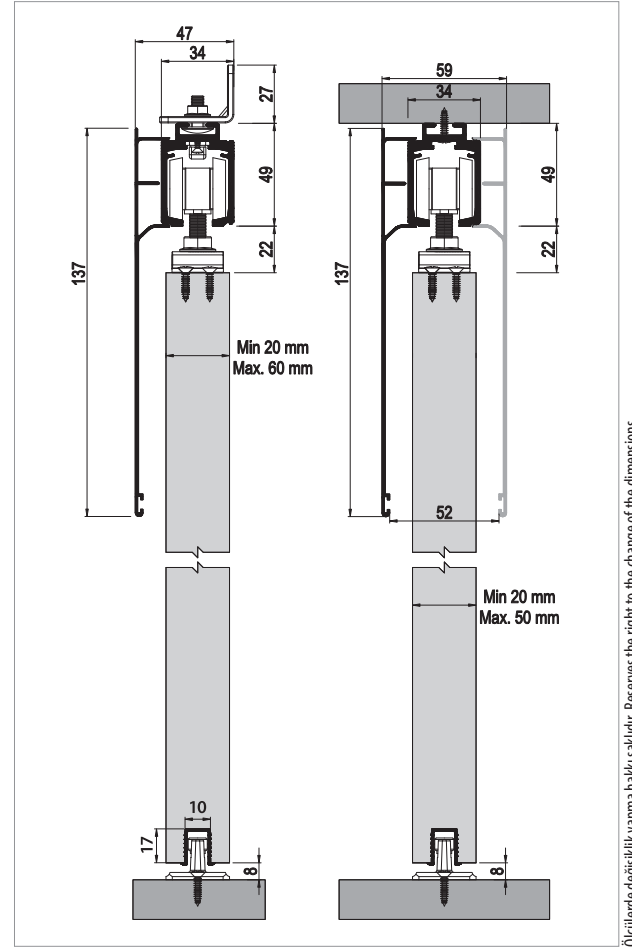

Kod / Code No	Açıklama / Description	Renk / Colour	Birim / Unit			Profil mt. / Profiles mt.	Bağ / Bnd.
120-9701-1600	9700 SFT - 120 Kg Yavaşlatıcılı Sürgü Kapı Sistemi / Sliding Door System - Has Soft Closing	Gri / Grey	1 Kapı / 1 Kit	12	360	- - -	-
150-9750-1400	Alüminyum Üst Ray Profili / Aluminium Top Rail Profile	Pres / Uncoated	mt.	-	-	2,0 - 3,0	2 ad/pcs
150-9162-1410	Alüminyum Alt Klavuz Profili / Aluminium Bottom Slider Profile	Eloksal / Mat Anodized	mt.	-	-	- - 3,0	20 ad/pcs
150-9765-1410	Alüminyum Alın Kapama / Aluminium Cover Front	Eloksal / Mat Anodized	mt.	-	-	2,0 - 3,0	2 ad/pcs

DoorSlide 9706

120 KG TEK YÖNE YAVAŞLATICILI SÜRGÜ KAPI SİSTEMİ • SLIDING DOOR SYSTEM - HAS SOFT CLOSING

9705 SFT

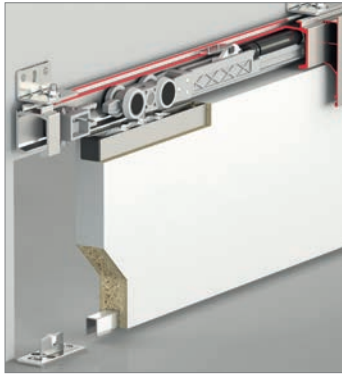

Bilgi / Information

- Minimum kapı genişliği 500 mm olmalıdır.
- Min. Door width 500 mm

Yavaşlatıcı Alternatifi / Soft Closer Alternative

- Sistem üzerinde tek yöne yavaşlatıcı mevcuttur.
- The system has one way soft closing.



9706 1 Takım İçeriği / 1 Kit Includes

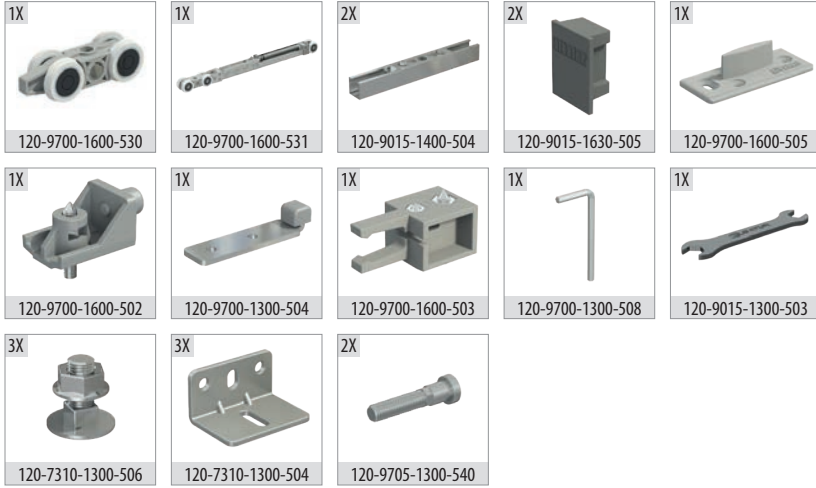

Ray Profilleri / Rail Profiles

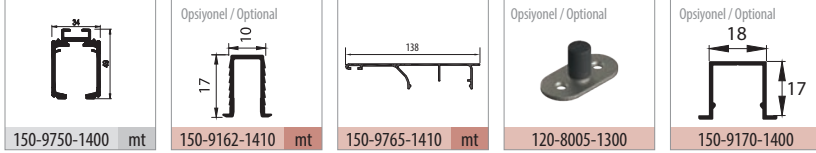

Uygulama / Application



Teknik Detay / Technical Detail

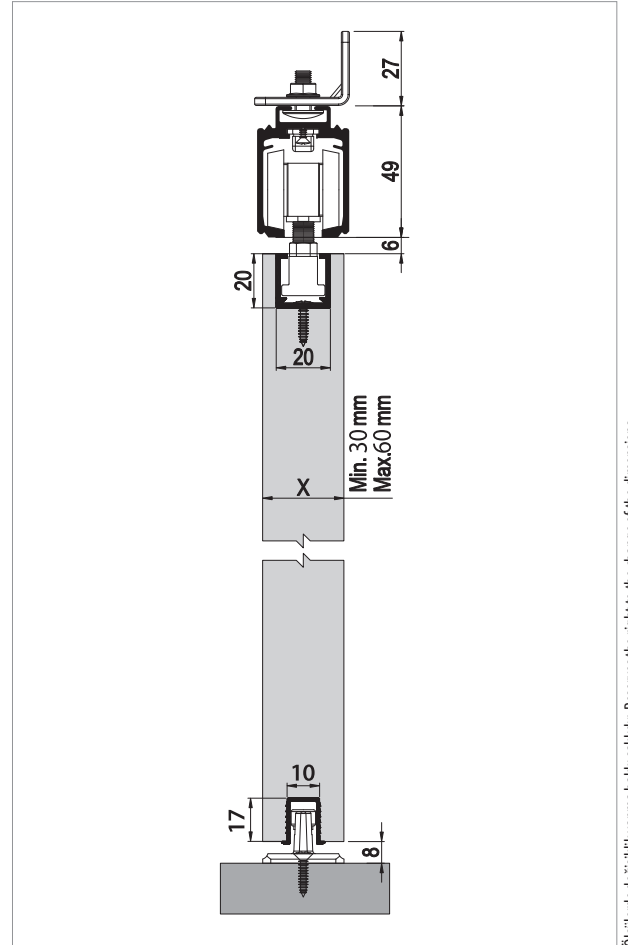

Ölçülerde değişiklik yapma hakkı saklıdır. Reserves the right to the change of the dimensions.

Kod / Code No	Açıklama / Description	Renk / Colour	Birim / Unit			Profil mt. / Profiles mt.	Bağ / Bnd.		
120-9706-1600	120 Kg Yavaşlatıcılı Sürgü Kapı Sistemi / Sliding Door System - Has Soft Closing	Gri / Grey	1 Kapı / 1 Kit	8	400	-	-	-	
150-9750-1400	Alüminyum Üst Ray Profili / Aluminium Top Rail Profile	Pres / Uncoated	mt.	-	-	2,0	-	3,0	2 ad/pcs
150-9162-1410	Alüminyum Alt Klavuz Profili / Aluminium Bottom Slider Profile	Eloksal / Mat Anodized	mt.	-	-	-	-	3,0	20 ad/pcs
150-9765-1410	Alüminyum Alın Kapama / Aluminium Cover Front	Eloksal / Mat Anodized	mt.	-	-	2,0	-	3,0	2 ad/pcs

DoorSlide 9720

120 KG ÇİFT YÖNE YAVAŞLATICILI SÜRGÜ KAPI SİSTEMİ • SLIDING DOOR SYSTEM - HAS SOFT CLOSING



Bilgi / Information

- Minimum kapı genişliği 830 mm olmalıdır.
- Min. Door width 830 mm

Yavaşlatıcı Alternatifi / Soft Closer Alternative

- Sistem üzerinde çift yöne yavaşlatıcı mevcuttur.
- The system has two way soft closing.



9720 1 Takım İçeriği / 1 Kit Includes

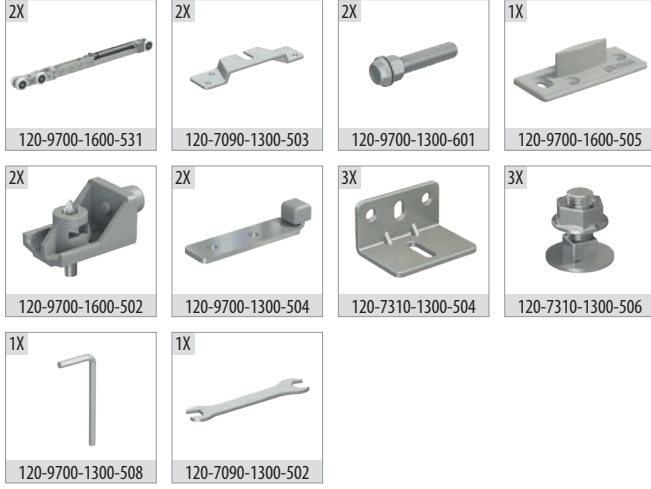

Ray Profilleri / Rail Profiles

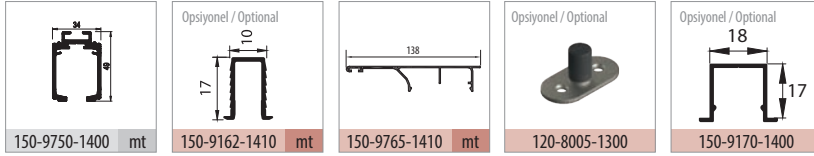

Uygulama / Application



Teknik Detay / Technical Detail

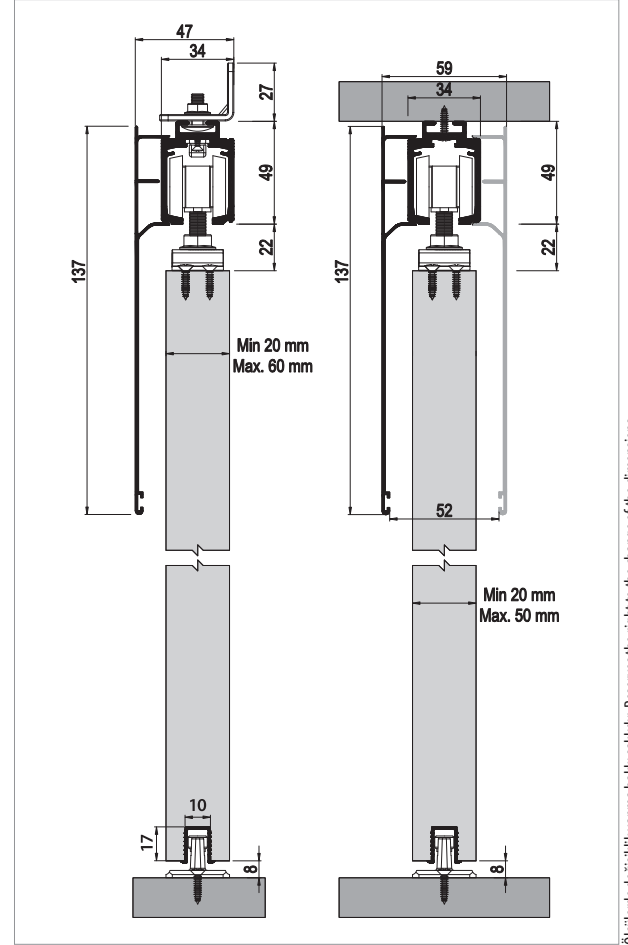

Kod / Code No	Açıklama / Description	Renk / Colour	Birim / Unit			Profil mt. / Profiles mt.	Bağ / Bnd.
120-9720-1600	120 Kg Yavaşlatıcılı Sürgü Kapı Sistemi / Sliding Door System - Has Soft Closing	Gri / Grey	1 Kapı / 1 Kit	8	400	- - -	-
150-9750-1400	Alüminyum Üst Ray Profili / Aluminium Top Rail Profile	Pres / Uncoated	mt.	-	-	2,0 - 3,0	2 ad/pcs
150-9162-1410	Alüminyum Alt Klavuz Profili / Aluminium Bottom Slider Profile	Eloksal / Mat Anodized	mt.	-	-	- 3,0	20 ad/pcs
150-9765-1410	Alüminyum Alın Kapama / Aluminium Cover Front	Eloksal / Mat Anodized	mt.	-	-	2,0 - 3,0	2 ad/pcs

DoorSlide 9725

120 KG ÇİFT YÖNE YAVAŞLATICILI SÜRGÜ KAPI SİSTEMİ - SLIDING DOOR SYSTEM - HAS SOFT CLOSING

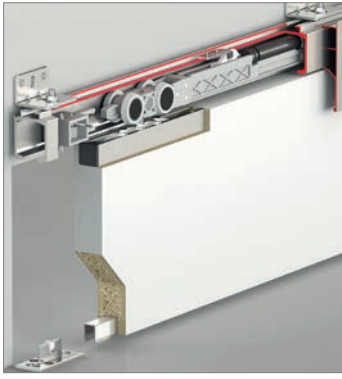

Bilgi / Information

- Minimum kapı genişliği 830 mm olmalıdır.
- Min. Door width 830 mm

Yavaşlatıcı Alternatifi / Soft Closer Alternative

- Sistem üzerinde çift yöne yavaşlatıcı mevcuttur.
- The system has two way soft closing.



9725 1 Takım İçeriği / 1 Kit Includes



Ray Profilleri / Rail Profiles

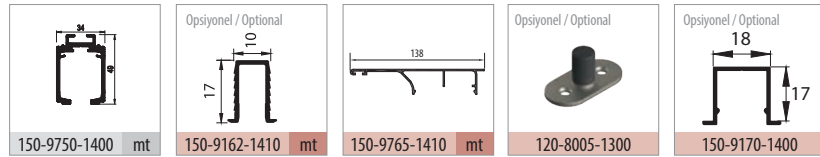

Uygulama / Application



Teknik Detay / Technical Detail

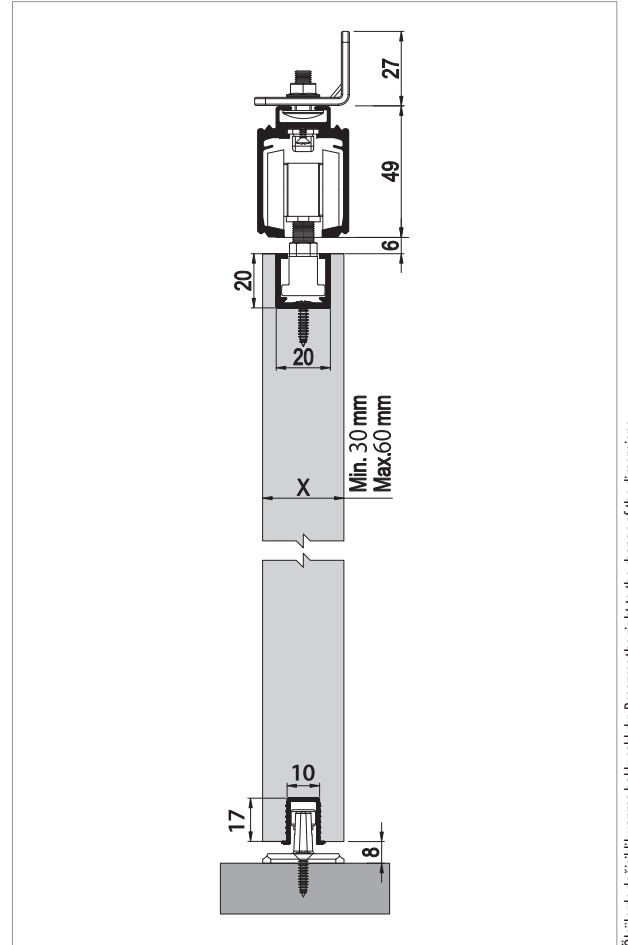

Ölçülerde değişiklik yapma hakkı saklıdır. Reserves the right to the change of the dimensions.

Kod / Code No	Açıklama / Description	Renk / Colour	Birim / Unit			Profil mt. / Profiles mt.	Bağ / Bnd.		
120-9725-1600	120 Kg Yavaşlatıcılı Sürgü Kapi Sistemi / Sliding Door System - Has Soft Closing	Gri / Grey	1 Kapı / 1 Kit	8	400	-	-	-	
150-9750-1400	Alüminyum Üst Ray Profili / Aluminium Top Rail Profile	Pres / Uncoated	mt.	-	-	2,0	-	3,0	2 ad/pcs
150-9162-1410	Alüminyum Üst Klavuz Profili / Aluminium Bottom Slider Profile	Eloksal / Mat Anodized	mt.	-	-	-	-	3,0	20 ad/pcs
150-9765-1410	Alüminyum Alın Kapama / Aluminium Cover Front	Eloksal / Mat Anodized	mt.	-	-	2,0	-	3,0	2 ad/pcs

DoorSlide 7310

51 KG SÜRGÜLÜ KAPI SİSTEMİ • SLIDING DOOR SYSTEM



7310 1 Takım İçeriği / 1 Kit Includes

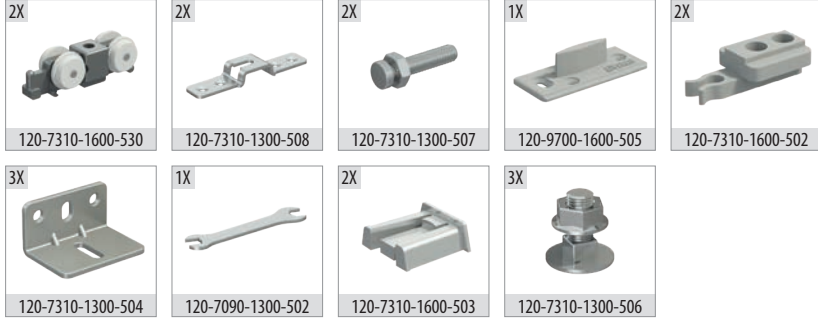

Ray Profilleri / Rail Profiles

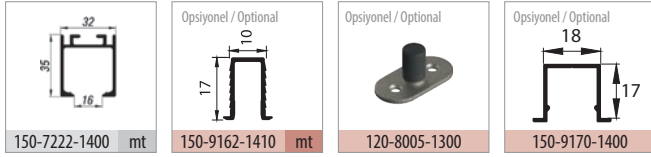

Uygulama / Application



Teknik Detay / Technical Detail

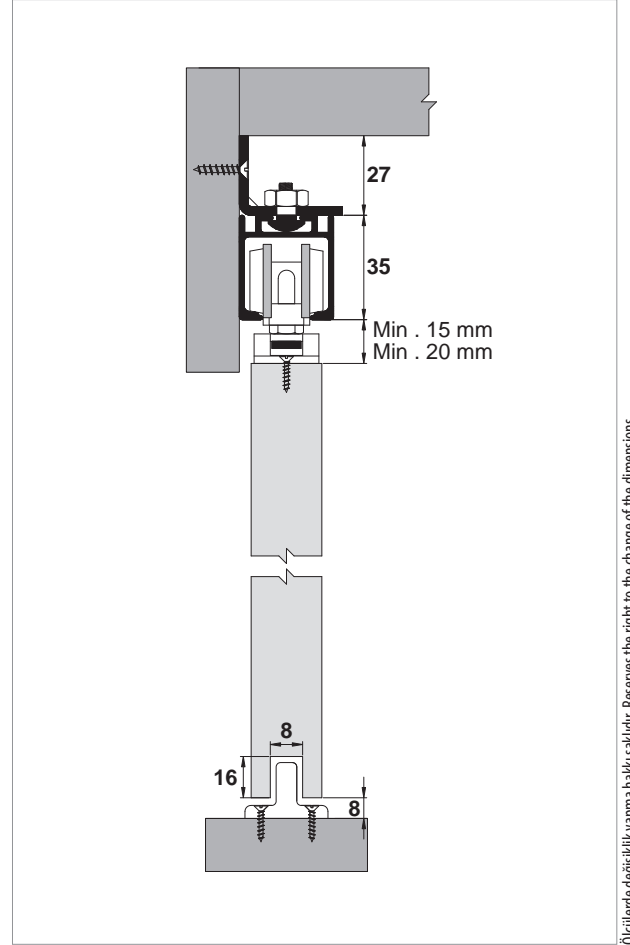

Ölçülerde değişiklik yapma hakkı saklıdır. Reserves the right to the change of the dimensions.

Kod / Code No	Açıklama / Description	Renk / Colour	Birim / Unit			Profil mt. / Profiles mt.			Bağ / Bnd.
120-7310-1600	51 Kg Sürgülü Kapı Sistemi / Sliding Door System	Gri / Grey	1 Kapı / 1 Kit	24	768	-	-	-	-
150-7222-1400	Alüminyum Üst Ray Profili / Aluminium Top Rail Profile	Pres/ Uncoated	mt.	-	-	2,0	-	3,0	6 ad/pcs
150-9162-1410	Alüminyum Alt Klavuz Profili / Aluminium Bottom Slider Profile	Eloksal / Mat Anodized	mt.	-	-	-	-	3,0	20 ad/pcs

DoorSlide 7099

80 KG SÜRGÜLÜ KAPI SİSTEMİ RULMANLI • SLIDING DOOR SYSTEM HAS BALL BEARING



7099 1 Takım İçeriği / 1 Kit Includes

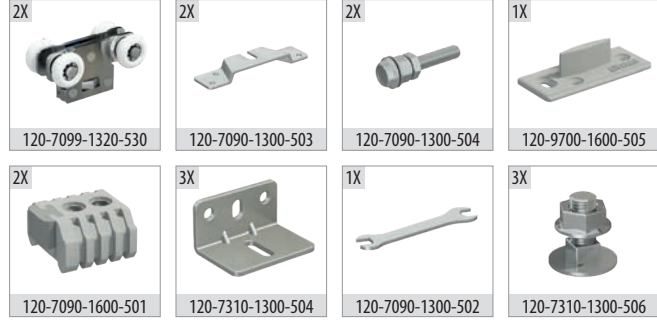

Ray Profilleri / Rail Profiles

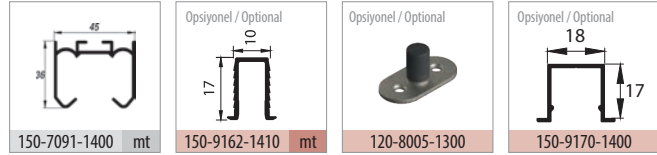

Uygulama / Application



Teknik Detay / Technical Detail

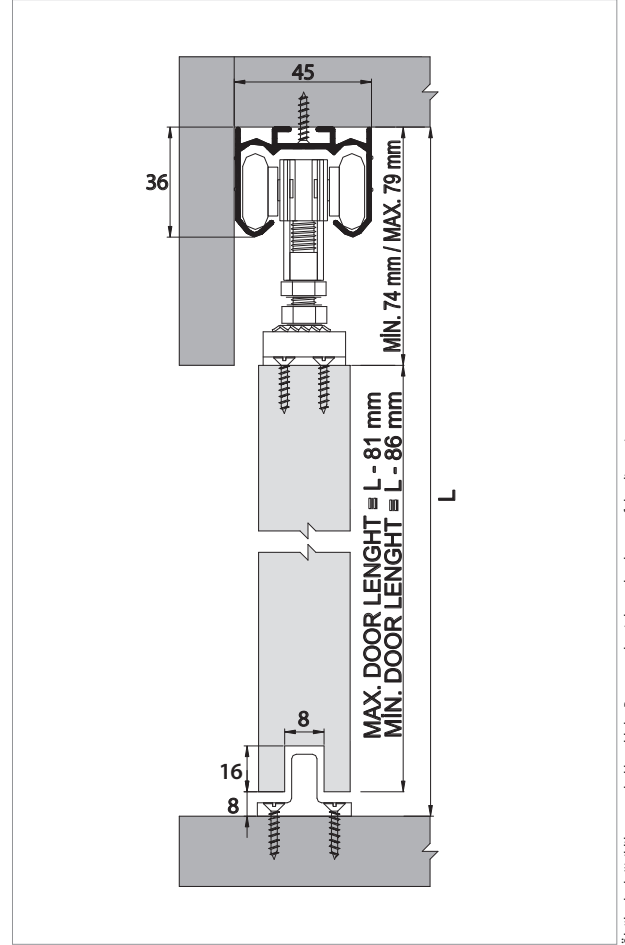

Ölçülerde değişiklik yapma hakkı saklıdır. Reserves the right to the change of the dimensions.

Kod / Code No	Açıklama / Description	Renk / Colour	Birim / Unit			Profil mt. / Profiles mt.	Bağ / Bnd.
120-7099-1320	80 Kg Sürgü Kapa Sistemi / Sliding Door System	Galveniz / Galvanized	1 Kapı / 1 Kit	24	576	-	-
150-7091-1400	Alüminyum Üst Ray Profili / Aluminium Top Rail Profile	Pres / Uncoated	mt.	-	-	2,0	3,0
150-9162-1410	Alüminyum Alt Klavuz Profili / Aluminium Bottom Slider Profile	Eloksal / Mat Anodized	mt.	-	-	-	3,0

DoorSlide 7380

80 KG SÜRGÜLÜ KAPI SİSTEMİ RULMANLI • SLIDING DOOR SYSTEM HAS BALL BEARING



7380 1 Takım İçeriği / 1 Kit Includes

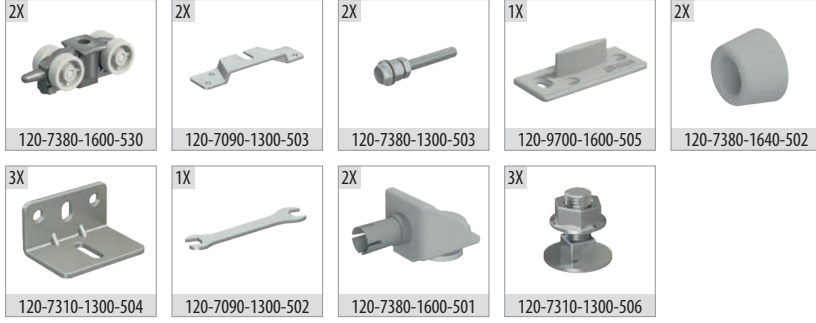

Ray Profilleri / Rail Profiles

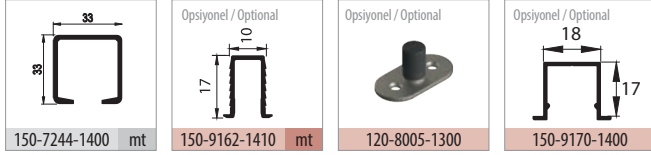

Uygulama / Application



Teknik Detay / Technical Detail

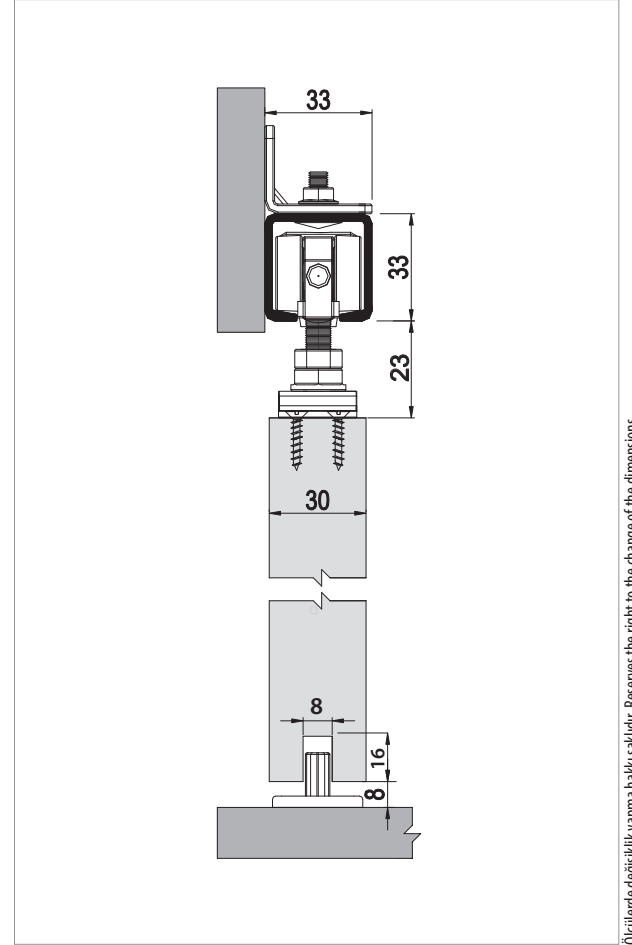

Ölçülerde değişiklik yapma hakkı saklıdır. Reserves the right to the change of the dimensions.

Kod / Code No	Açıklama / Description	Renk / Colour	Birim / Unit			Profil mt. / Profiles mt.			Bağ / Bnd.
120-7380-1600	80 Kg Sürgülü Kapı Sistemi / Sliding Door System	Gri / Grey	1 Kapı / 1 Kit	24	768	-	-	-	-
150-7244-1400	Alüminyum Üst Ray Profili / Aluminium Top Rail Profile	Pres / Uncoated	mt.	-	-	2,0	-	3,0	6 ad/pcs
150-9162-1410	Alüminyum Alt Klavuz Profili / Aluminium Bottom Slider Profile	Eloksal / Mat Anodized	mt.	-	-	-	-	3,0	20 ad/pcs

DoorSlide 9100

250 KG SÜRGÜLÜ KAPI SİSTEMİ • SLIDING DOOR SYSTEM



Bilgi / Information

- Minimum kapı panel kalınlığı 40 mm. olmalıdır.
- Door panel's thickness should be minimum 40 mm.



9100 1 Takım İçeriği / 1 Kit Includes

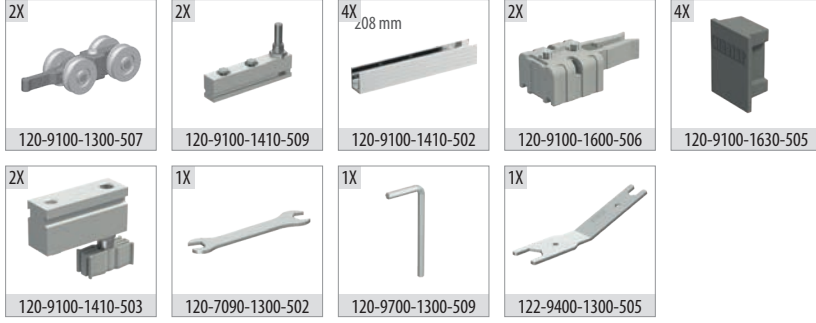

Ray Profilleri / Rail Profiles

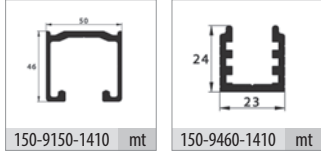

Opsiyonel Aksesuar / Optional Accessories



Uygulama / Application



Teknik Detay / Technical Detail

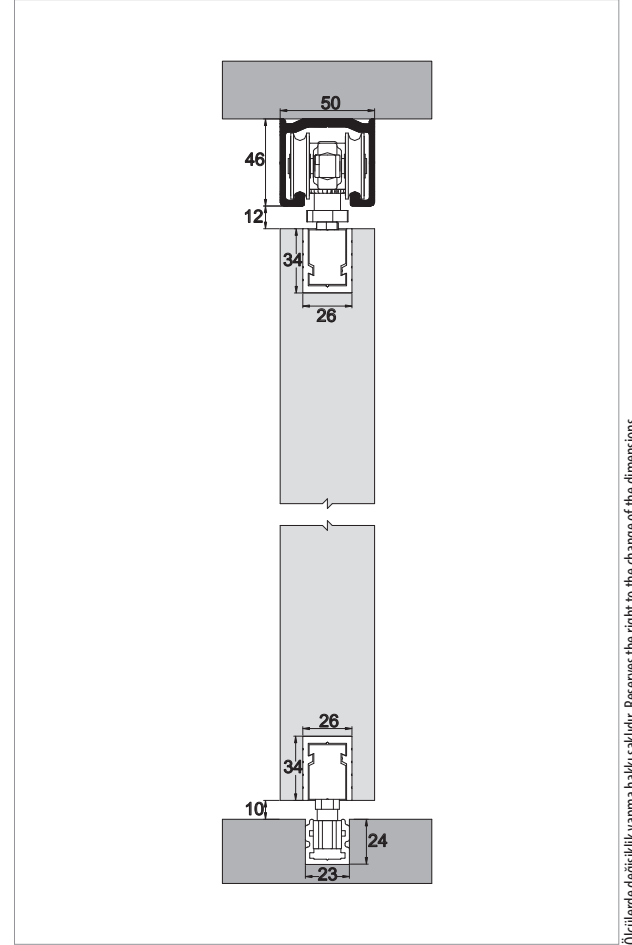

Ölçülerde değişiklik yapma hakkı saklıdır. Reserves the right to the change of the dimensions.

Kod / Code No	Açıklama / Description	Renk / Colour	Birim / Unit			Profil mt. / Profiles mt.	Bağ / Bnd.
120-9100-1300	250 Kg Sürgü Kapi Sistemi / Sliding Door System	Grİ / Grey	1 Kapi / 1 Kit	12	360	- - -	-
120-9100-1300-504	Askı Aparatı / Hanger Parts	Galvaniz / Galvanized	1 Adet / 1 Pcs	50	2.400	- - -	-
150-9150-1410	Alüminyum Üst Ray Profili / Aluminium Top Rail Profile	Eloksal / Mat Anodized	mt.	-	-	2,0 - 3,0	2 ad/pcs
150-9460-1410	Alüminyum Alt Ray Profili / Aluminium Bottom Rail Profile	Eloksal / Mat Anodized	mt.	-	-	2,0 - 3,0	8 ad/pcs

DoorSlide 9700

120 KG SÜRGÜLÜ KAPI SİSTEMİ • SLIDING DOOR SYSTEM



9700 1 Takım İçeriği / 1 Kit Includes

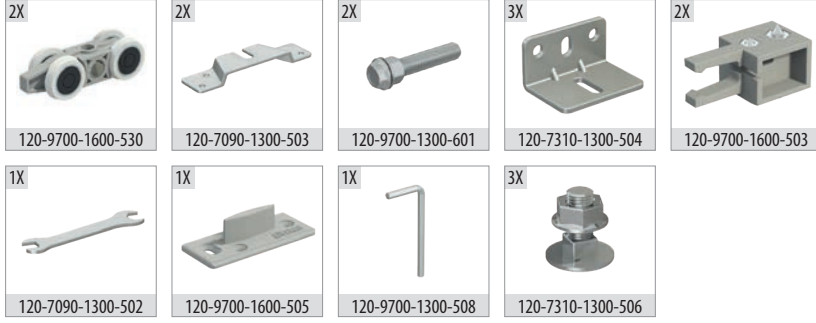

Ray Profilleri / Rail Profiles

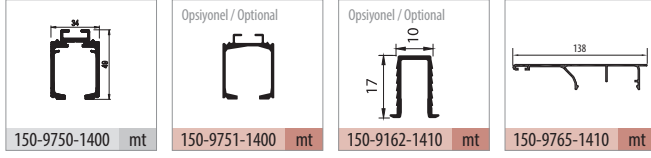

Opsiyonel Aksesuar / Optional Accessories

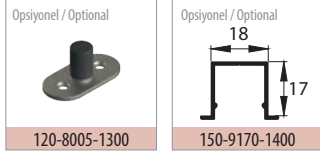

Uygulama / Application



Teknik Detay / Technical Detail

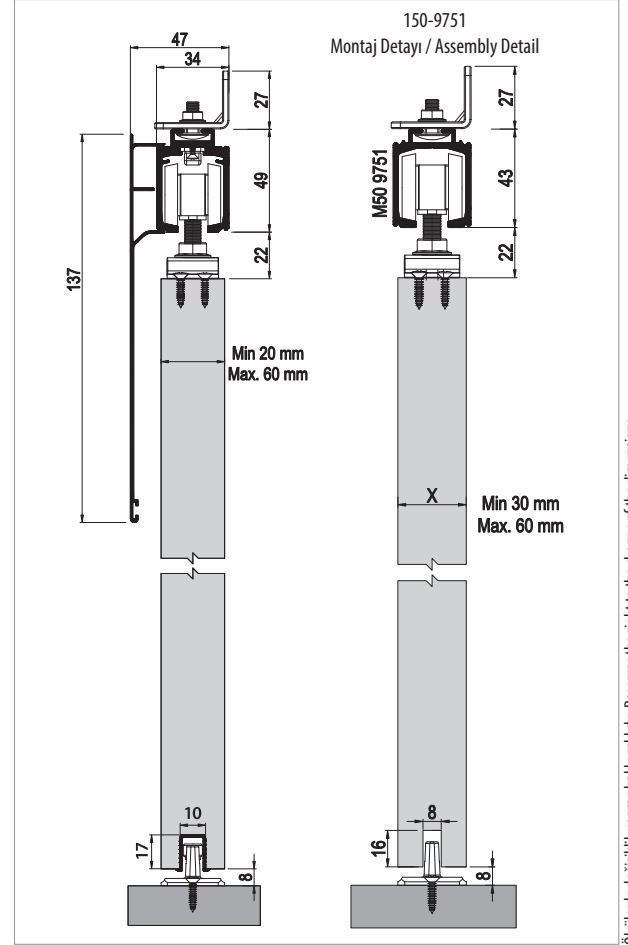

Ölçülerde değişiklik yapma hakkı saklıdır. Reserves the right to the change of the dimensions.

Kod / Code No	Açıklama / Description	Renk / Colour	Birim / Unit			Profil mt. / Profiles mt.			Bağ / Bnd.
120-9700-1600	120 Kg Sürgü Kapı Sistemi / Sliding Door System	Gri / Grey	1 Kapı / 1 Kit	24	576	-	-	-	-
150-9750-1400	Alüminyum Üst Ray Profili / Aluminium Top Rail Profile	Pres / Uncoated	mt.	-	-	2,0	-	3,0	2 ad/pcs
150-9751-1400	Alüminyum Üst Ray Profili / Aluminium Top Rail Profile	Pres / Uncoated	mt.	-	-	2,0	-	3,0	2 ad/pcs
150-9162-1410	Alüminyum Alt Klavuz Profili / Aluminium Bottom Slider Profile	Eloksal / Mat Anodized	mt.	-	-	-	-	3,0	20 ad/pcs
150-9765-1410	Alüminyum Alın Kapama / Aluminium Cover Front	Eloksal / Mat Anodized	mt.	-	-	2,0	-	3,0	2 ad/pcs

DoorSlide 7120

120 KG SÜRGÜLÜ KAPI SİSTEMİ • SLIDING DOOR SYSTEM



7120 1 Takım İçeriği / 1 Kit Includes

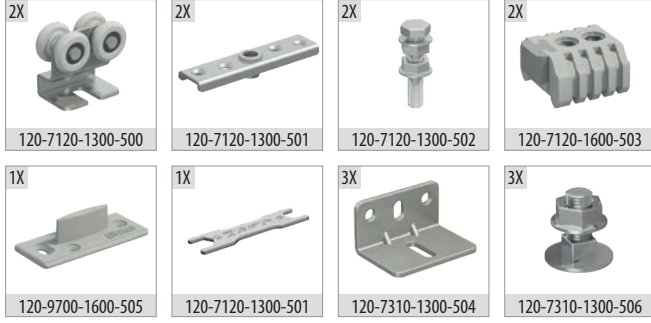

Ray Profilleri / Rail Profiles

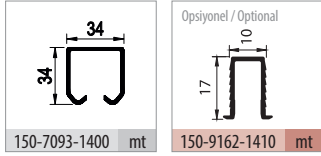

Opsiyonel Aksesuar / Optional Accessories

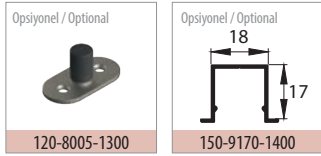

Uygulama / Application



Teknik Detay / Technical Detail

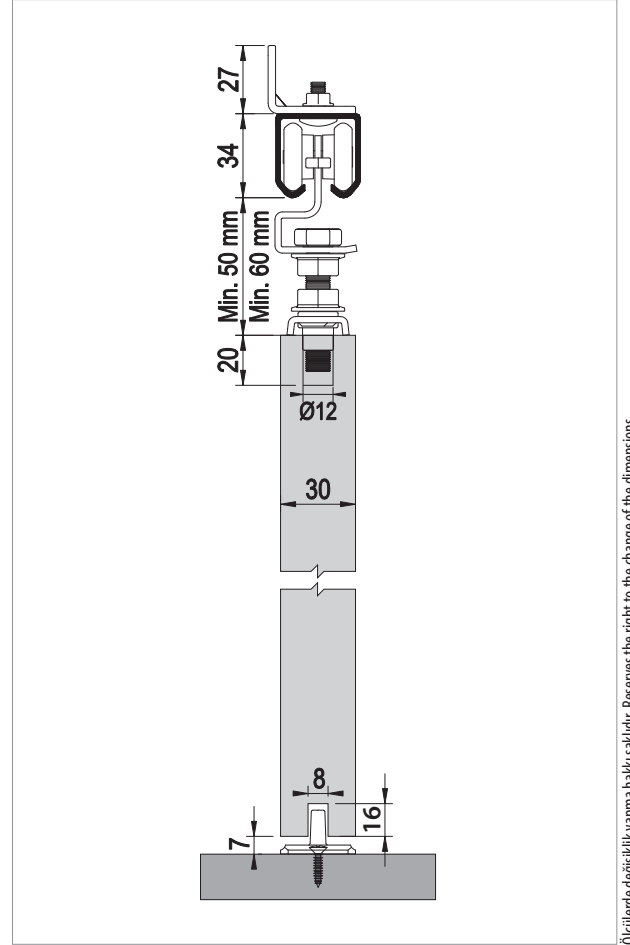

Ölçülerde değişiklik yapma hakkı saklıdır. Reserves the right to the change of the dimensions.

Kod / Code No	Açıklama / Description	Renk / Colour	Birim / Unit			Profil mt. / Profiles mt.			Bağ / Bnd.
120-7120-1300	120 Kg Sürgü Kapı Sistemi / Sliding Door System	Gri / Grey	1 Kapı / 1 Kit	24	576	-	-	-	-
150-7093-1400	Alüminyum Üst Ray Profili / Aluminium Top Rail Profile	Pres / Uncoated	mt.	-	-	2,0	-	3,0	6 ad/pcs
150-9162-1410	Alüminyum Alt Klavuz Profili / Aluminium Bottom Slider Profile	Eloksal / Mat Anodized	mt.	-	-	-	-	3,0	20 ad/pcs

DoorSync 9800

120 KG HALATLI SÜRGÜ KAPI SİSTEMİ • FUNICULAR SLIDING DOOR SYSTEM

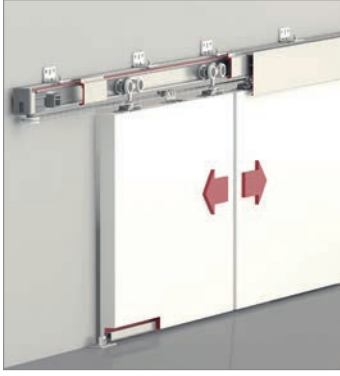

9800 1 Set İçeriği / 1 Set Includes

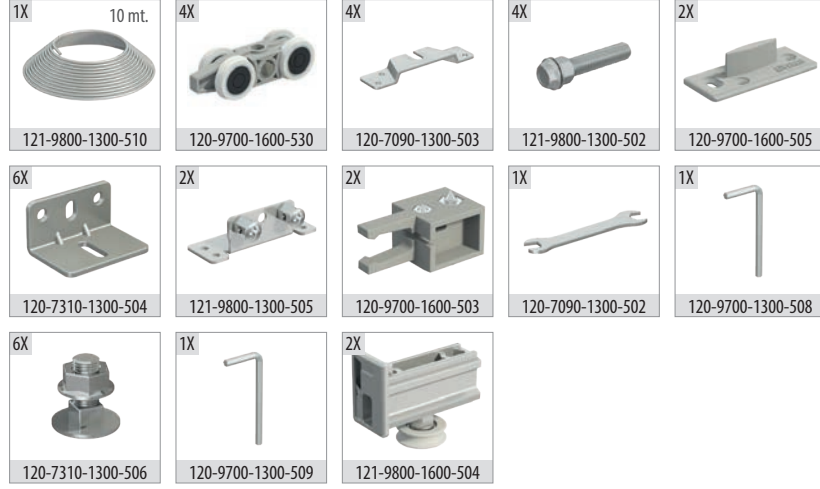

Ray Profilleri / Rail Profiles

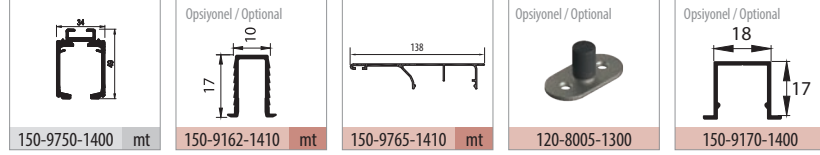

Uygulama / Application



Teknik Detay / Technical Detail

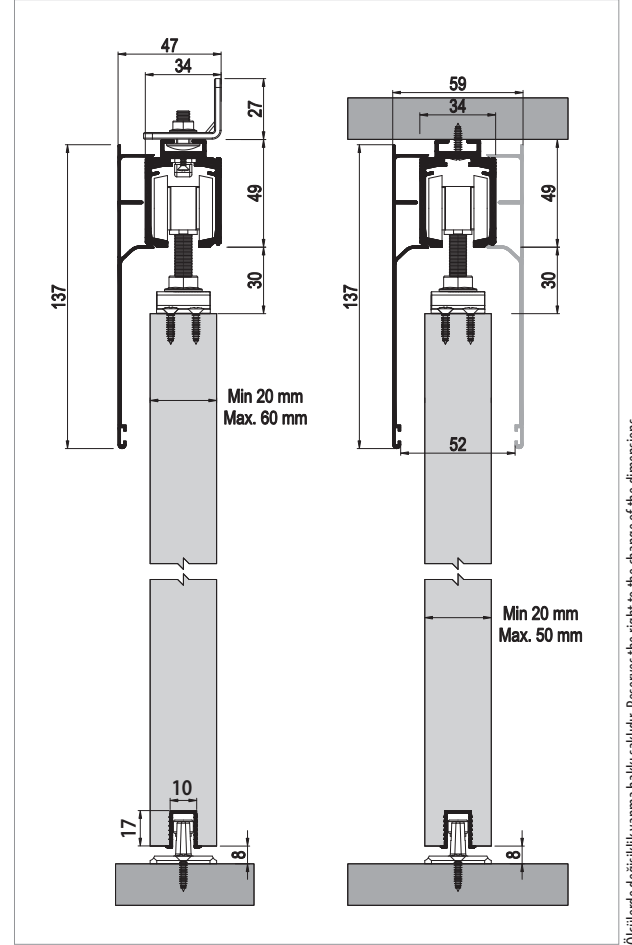

Ölçülerde değişiklik yapma hakkı saklıdır. Reserves the right to the change of the dimensions.

Kod / Code No	Açıklama / Description	Renk / Colour	Birim / Unit			Profil mt. / Profiles mt.			Bağ / Bnd.
121-9800-1600	120 Kg Senkronize Sürgü Kapı Sistemi / Funicular Sliding Door System	Gri / Grey	2 Kapı / 1 Set	12	216	-	-	-	-
150-9750-1400	Alüminyum Üst Ray Profili / Aluminium Top Rail Profile	Pres / Uncoated	mt.	-	-	3,0	4,0	6,0	2 ad/pcs
150-9162-1410	Alüminyum Alt Klavuz Profili / Aluminium Bottom Slider Profile	Eloksal / Mat Anodized	mt.	-	-	3,0	-	-	20 ad/pcs
150-9765-1410	Alüminyum Alın Kapama / Aluminium Cover Front	Eloksal / Mat Anodized	mt.	-	-	3,0	4,0	6,0	2 ad/pcs

DoorSync 9810

80 KG HALATLI SÜRGÜ KAPI SİSTEMİ • FUNICULAR SLIDING DOOR SYSTEM

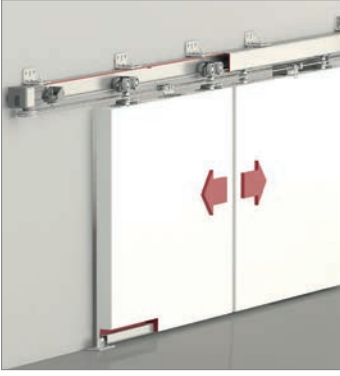

9810 1 Set İçeriği / 1 Set Includes



Ray Profilleri / Rail Profiles

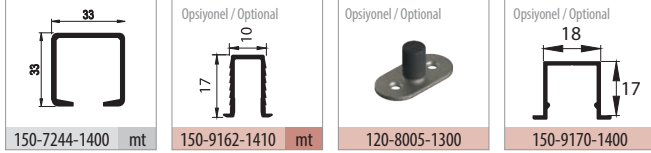

Uygulama / Application



Teknik Detay / Technical Detail

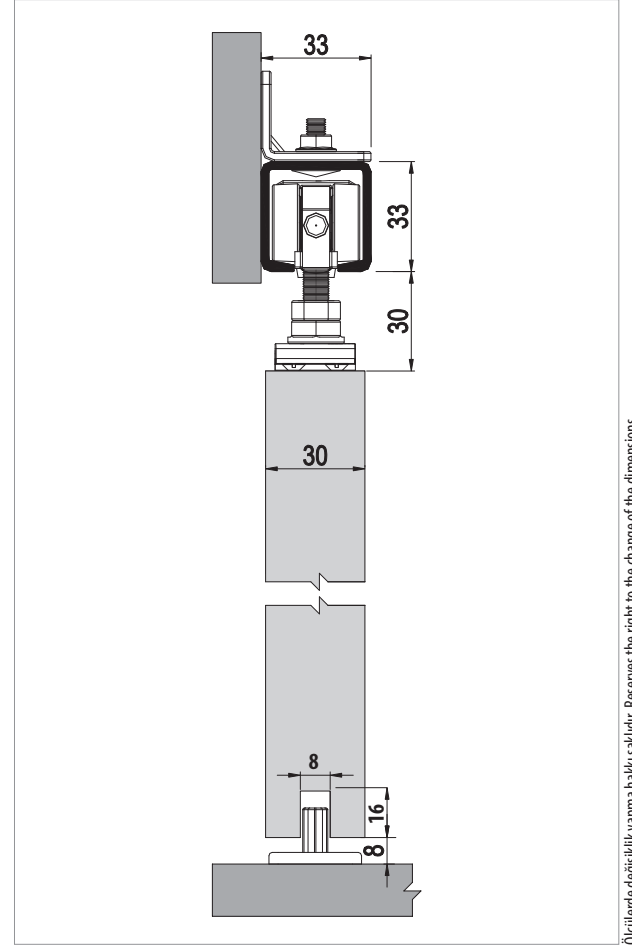

Ölçülerde değişiklik yapma hakkı saklıdır. Reserves the right to the change of the dimensions.

Kod / Code No	Açıklama / Description	Renk / Colour	Birim / Unit			Profil mt. / Profiles mt.			Bağ / Bnd.
121-9810-1600	80 Kg Senkronize Sürgü Kapi Sistemi / Funicular Sliding Door System	Gri / Grey	2 Kapı / 1 Set	12	216	-	-	-	-
150-7244-1400	Alüminyum Üst Ray Profili / Aluminium Top Rail Profile	Pres / Uncoated	mt.	-	-	3,0	4,0	6,0	6 ad/pcs
150-9162-1410	Alüminyum Alt Klavuz Profili / Aluminium Bottom Slider Profile	Eloksal / Mat Anodized	mt.	-	-	-	-	3,0	20 ad/pcs

DoorSync 9820

120 KG ÇİFT YÖNE YAVAŞLATICILI HALATLI SÜRGÜ KAPI SİSTEMİ • FUNICULAR SLIDING DOOR SYSTEM - HAS SOFT CLOSING

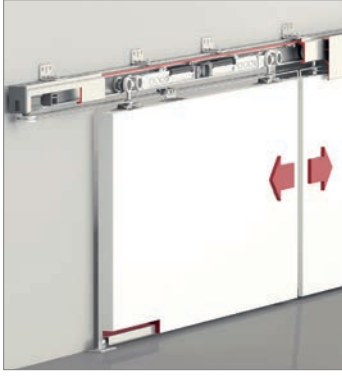

Bilgi / Information

- Minimum kapı genişliği 830 mm olmalıdır.
- Min. Door width 830 mm

Yavaşlatıcı Alternatifi / Soft Closer Alternative

- Sistem üzerinde çift yöne yavaşlatıcı mevcuttur.
- The system has two way soft closing.



9820 1 Set İçeriği / 1 Set Includes

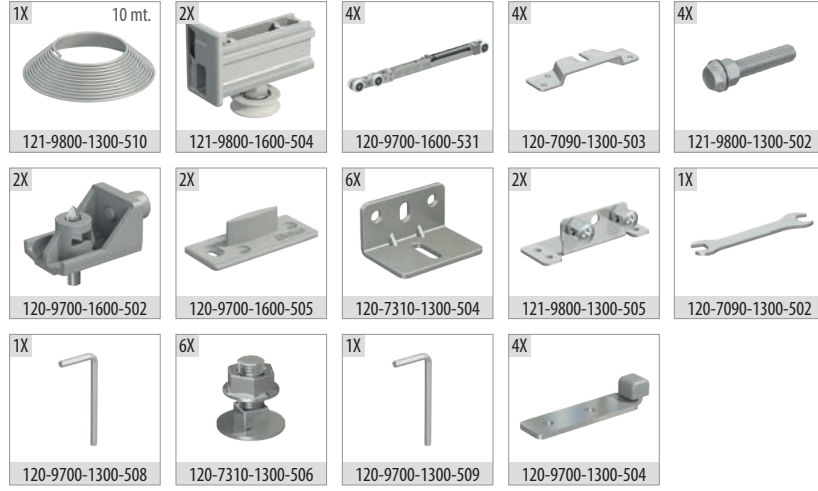

Ray Profilleri / Rail Profiles

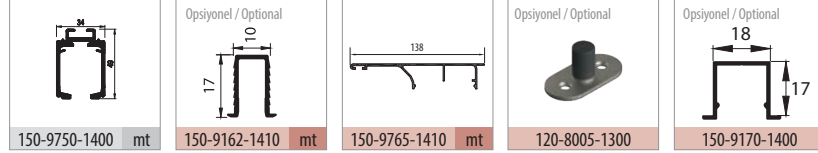

Uygulama / Application



Teknik Detay / Technical Detail

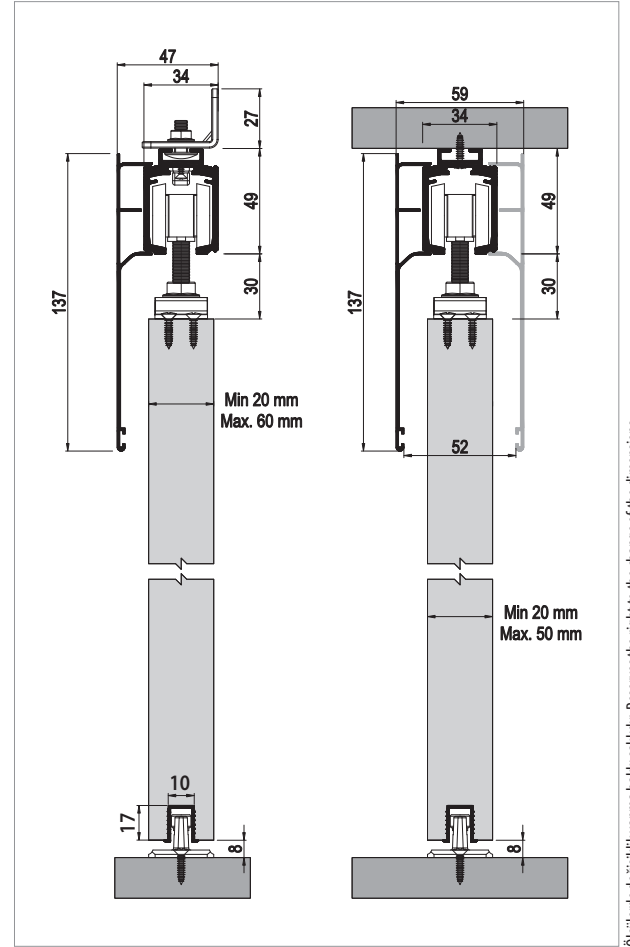

Ölçülerde değişiklik yapma hakkı saklıdır. Reserves the right to the change of the dimensions.

Kod / Code No	Açıklama / Description	Renk / Colour	Birim / Unit			Profil mt. / Profiles mt.	Bağ / Bnd.		
121-9820-1600	120 Kg Yavaşlatıcılı Halatlı Sürgü Kapı Sistemi / Funicular Sliding Door Has Soft Closing	Gri / Grey	2 Kapı / 1 Set	12	216	-	-	-	
150-9750-1400	Alüminyum Üst Ray Profili / Aluminium Top Rail Profile	Pres / Uncoated	mt.	-	-	3,0	4,0	6,0	2 ad/pcs
150-9162-1410	Alüminyum Alt Klavuz Profili / Aluminium Bottom Slider Profile	Eloksal / Mat Anodized	mt.	-	-	3,0	-	-	20 ad/pcs
150-9765-1410	Alüminyum Alın Kapama / Aluminium Cover Front	Eloksal / Mat Anodized	mt.	-	-	3,0	4,0	6,0	2 ad/pcs

DoorSync 9830

60 KG ÇİFT YÖNE YAVAŞLATICILI HALATLI SÜRGÜ KAPI SİSTEMİ • FUNICULAR SLIDING DOOR SYSTEM - HAS SOFT CLOSING

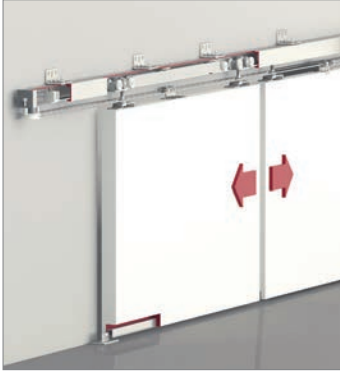

Bilgi / Information

- Minimum kapı genişliği 650 mm olmalıdır.
- Min. Door width 650 mm

Yavaşlatıcı Alternatifi / Soft Closer Alternative

- Sistem üzerinde çift yöne yavaşlatıcı mevcuttur.
- The system has two way soft closing.



9830 1 Set İçeriği / 1 Set Includes

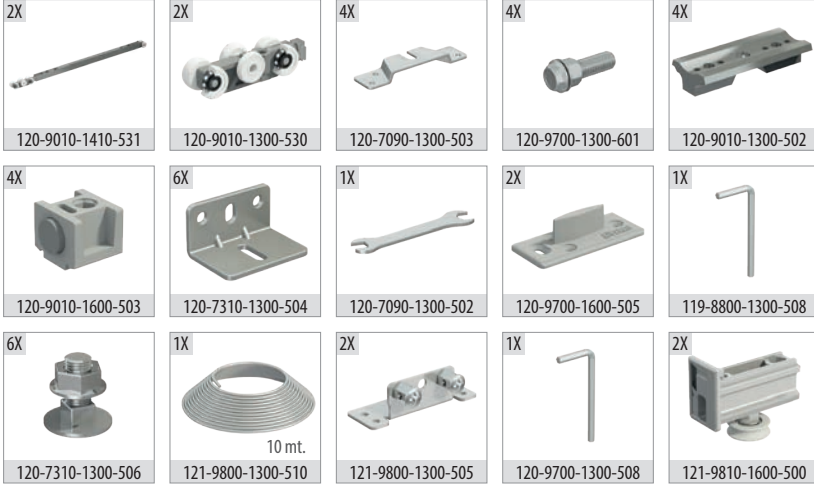

Ray Profilleri / Rail Profiles

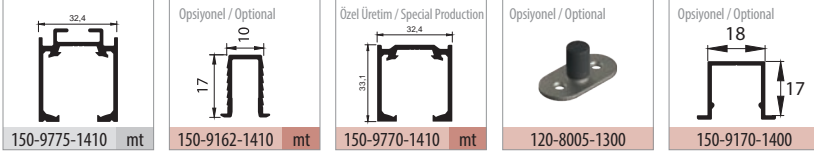

Uygulama / Application



Teknik Detay / Technical Detail

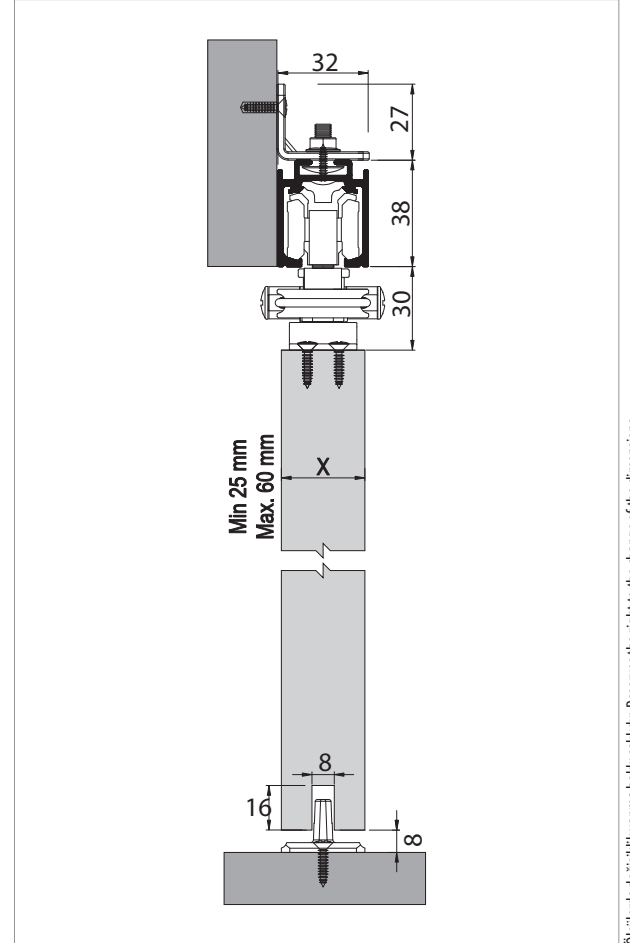

Ölçülerde değişiklik yapma hakkı saklıdır. Reserves the right to the change of the dimensions.

Kod / Code No	Açıklama / Description	Renk / Colour	Birim / Unit			Profil mt. / Profiles mt.			Bağ / Bnd.
121-9830-1410	60 Kg Yavaşlatıcı Halatlı Sürgü Kapı Sistemi / Funicular Sliding Door Has Soft Closing	Gri / Grey	2 Kapı / 1 Set	4	160	-	-	-	-
150-9775-1410	Alüminyum Üst Ray Profili / Aluminium Top Rail Profile	Eloksal / Mat Anodized	mt.	-	-	3,0	4,0	6,0	6 ad/pcs
150-9162-1410	Alüminyum Alt Klavuz Profili / Aluminium Bottom Slider Profile	Eloksal / Mat Anodized	mt.	-	-	3,0	4,0	-	20 ad/pcs

MasterFold 42

40 KG KATLANIR SÜRME KAPI SİSTEMİ • FOLDABLE DOOR MECHANISM - FOLDING DOOR

Yeni Ürün
New Product



Bilgi / Information

- 2 Kapılı mekanizma içermektedir.
- Includes 2 door mechanism.



9042 1 Set İçeriği / 1 Set Includes



Ray Profilleri / Rail Profiles

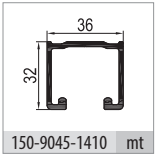

Uygulama / Application



Teknik Detay / Technical Detail

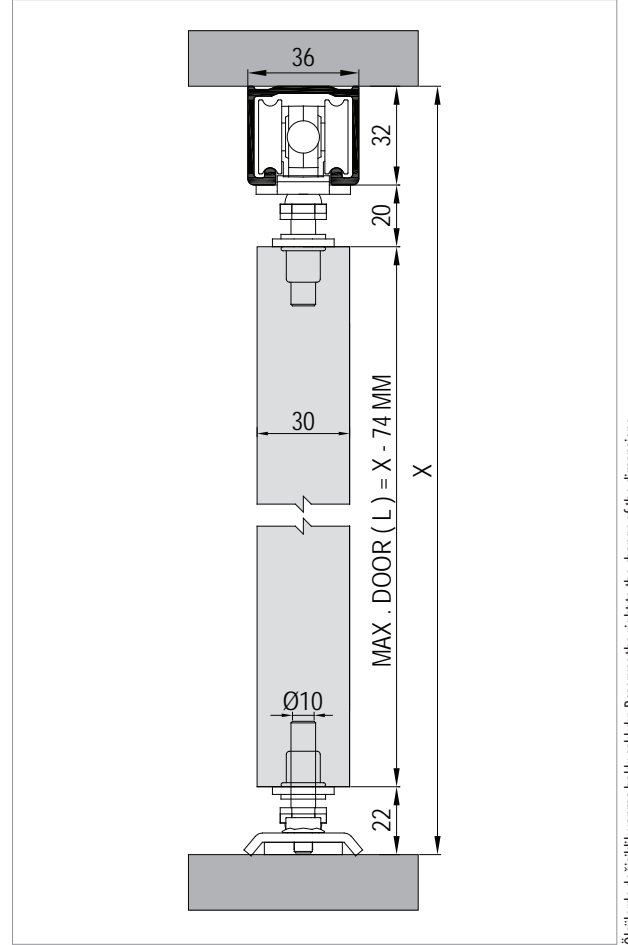

Ölçülerde değişiklik yapma hakkı saklıdır. Reserves the right to the change of the dimensions.

Kod / Code No	Açıklama / Description	Renk / Colour	Birim / Unit			Profil mt. / Profiles mt.	Bağ / Bnd.		
122-9042-1300	40 Kg Katlanır Sürme Kapı Sistemi / Foldable Door Mechanism - Folding Door	Gri / Grey	2 Kapı / 1 Set	12	360	-	-	-	
150-9045-1410	Alüminyum Üst Ray Profili / Aluminium Top Rail Profile	Eloksal / Mat Anodized	mt.	-	-	3,0	-	6,0	2 ad/pcs

MasterFold 44

40 KG KATLANIR SÜRME KAPI SİSTEMİ • FOLDABLE DOOR MECHANISM - FOLDING DOOR

Yeni Ürün
New Product



Bilgi / Information

- 4 Kapılık mekanizma içermektedir.
- Includes 4 door mechanism.



9044 1 Set İçeriği / 1 Set Includes

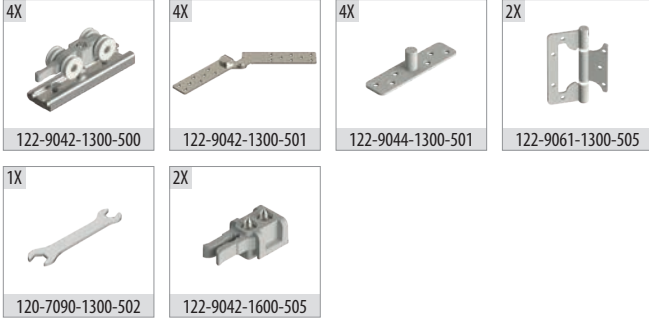

Ray Profilleri / Rail Profiles

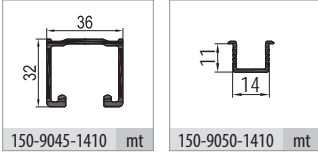

Uygulama / Application



Teknik Detay / Technical Detail

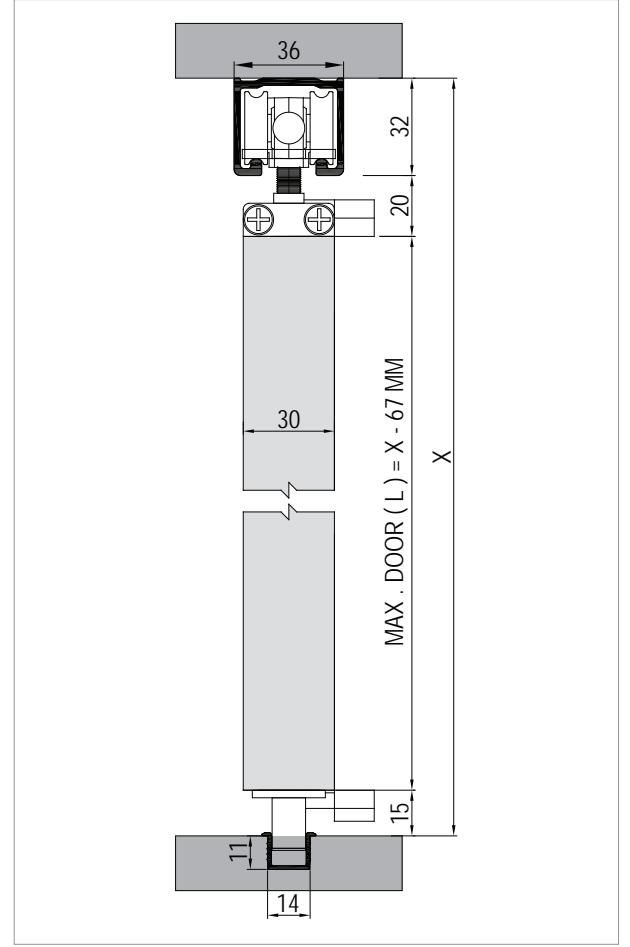

Ölçülerde değişiklik yapma hakkı saklıdır. Reserves the right to the change of the dimensions.

Kod / Code No	Açıklama / Description	Renk / Colour	Birim / Unit			Profil mt. / Profiles mt.	Bağ / Bnd.
122-9044-1300	40 Kg Katlanır Sürme Kapi Sistemi / Foldable Door Mechanism - Folding Door	Gri / Grey	4 Kapı / 1 Set	6	180	-	-
150-9045-1410	Alüminyum Üst Ray Profili / Aluminium Top Rail Profile	Eloksal / Mat Anodized	mt.	-	-	3,0	6,0
150-9050-1410	Alüminyum Alt Klavuz / Aluminium Bottom Slider	Eloksal / Mat Anodized	mt.	-	-	3,0	6,0

MasterFold 60

60 KG KATLANIR SÜRME KAPI SİSTEMİ • FOLDABLE DOOR MECHANISM - FOLDING DOOR

Yeni Ürün
New Product



Bilgi / Information

- Minimum kapı panel kalınlığı 36 mm. olmalıdır.
- Door panel's thickness should be minimum 36 mm.



9060 1 Takım İçeriği / 1 Kit Includes

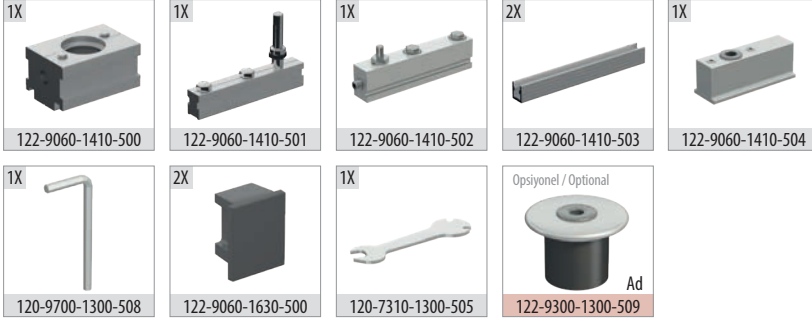

9061 1 Takım İçeriği / 1 Kit Includes

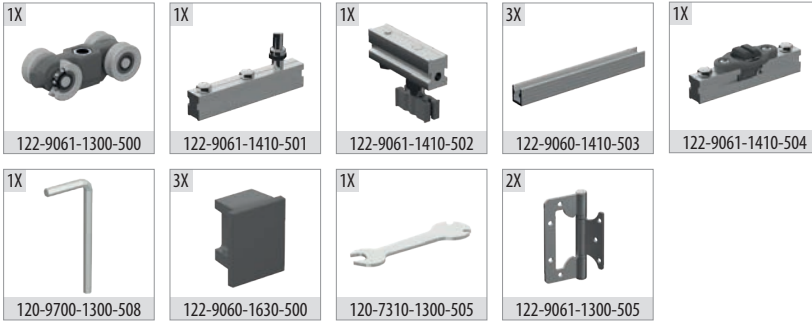

Ray Profilleri / Rail Profiles

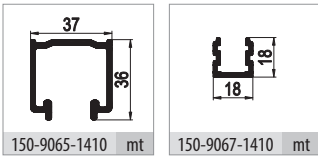

Uygulama / Application



Teknik Detay / Technical Detail

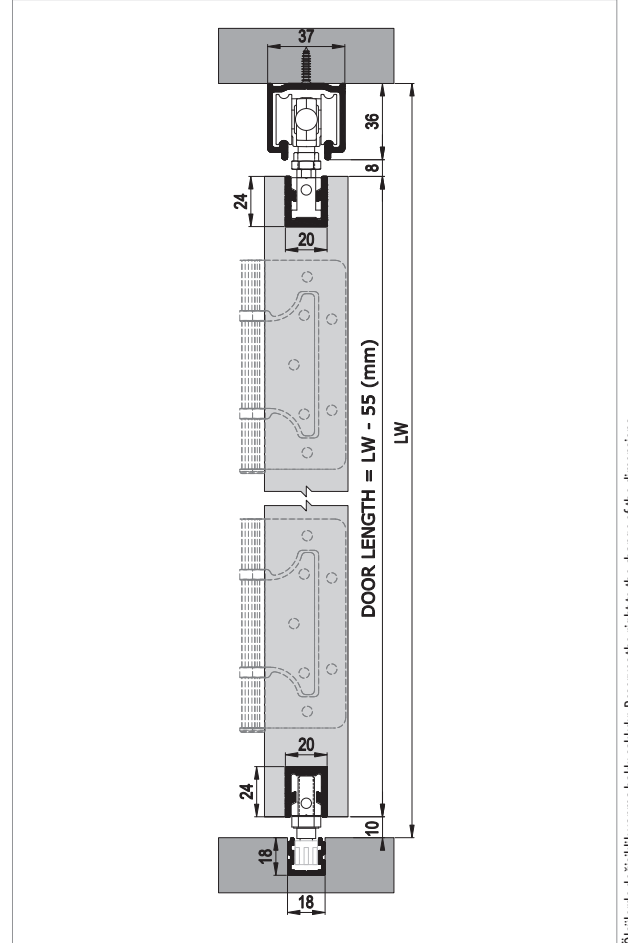

Ölçülerde değişiklik yapma hakkı saklıdır. Reserves the right to the change of the dimensions.

Kod / Code No	Açıklama / Description	Renk / Colour	Birim / Unit			Profil mt. / Profiles mt.	Bağ / Bnd.
122-9060-1410	Masterfold 60 - Sabit Kanat / Foldable Heavy Door System	Gri / Grey	1 Kapı / 1 Kit	16	512	-	-
122-9061-1410	Masterfold 60 - Sürme Katlanır Kapı Sistemi / Sliding Foldable Heavy Door System	Gri / Grey	1 Kapı / 1 Kit	16	512	-	-
122-9061-1300-505	Çelik Menteşe / Steel Hinge	Galvaniz / Galvanized	1 Adet / 1 Pcs	50	2.400	-	-
122-9300-1300-509	Zemin Pivot Burcu Paslanmaz / Ground Pivot Stainless	Galvaniz / Galvanized	1 Adet / 1 Pcs	100	9.600	-	-
150-9065-1410	Alüminyum Üst Ray Profili / Aluminium Top Rail Profile	Eloksal / Mat Anodized	mt.	-	-	-	6,0 6 ad/pcs
150-9067-1410	Alüminyum Alt Klavuz / Aluminium Bottom Slider	Eloksal / Mat Anodized	mt.	-	-	-	6,0 10 ad/pcs

MidFold 60

60 KG KATLANIR SÜRME KAPI SİSTEMİ • FOLDABLE DOOR MECHANISM - FOLDING DOOR

Yeni Ürün
New Product



Bilgi / Information

- Minimum kapı panel kalınlığı 36 mm. olmalıdır.
- Door panel's thickness should be minimum 36 mm.



9060 1 Takım İçeriği / 1 Kit Includes

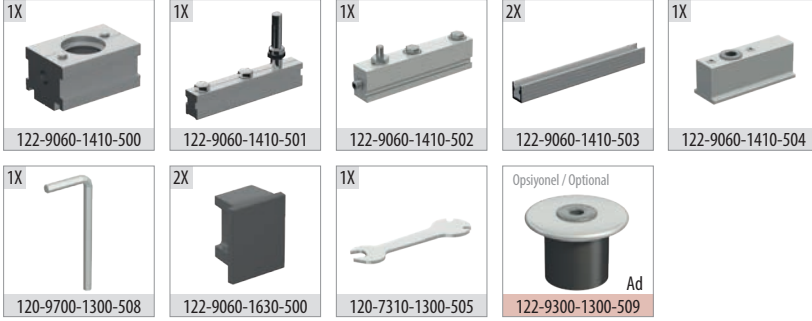

9062 1 Takım İçeriği / 1 Kit Includes

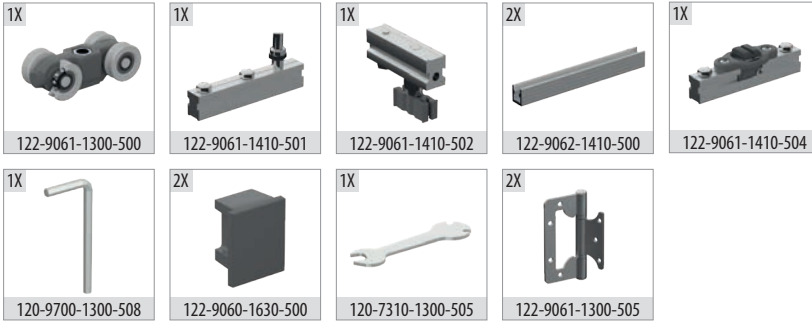

Ray Profilleri / Rail Profiles

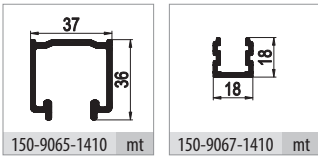

Uygulama / Application



Teknik Detay / Technical Detail

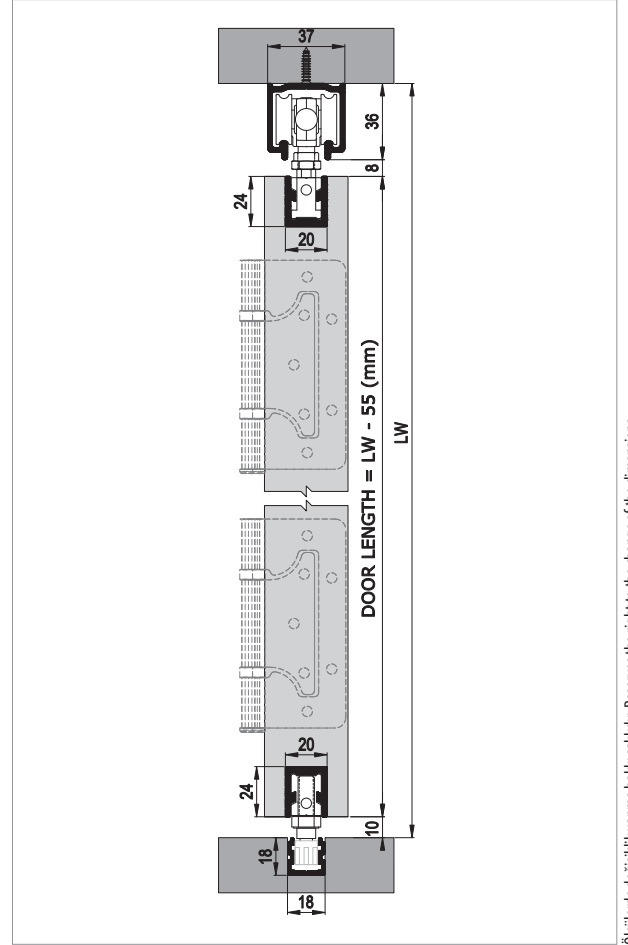

Ölçülerde değişiklik yapma hakkı saklıdır. Reserves the right to the change of the dimensions.

Kod / Code No	Açıklama / Description	Renk / Colour	Birim / Unit			Profil mt. / Profiles mt.	Bağ / Bnd.
122-9060-1410	Masterfold 60 - Sabit Kanat / Foldable Heavy Door System	Gri / Grey	1 Kapı / 1 Kit	16	512	-	-
122-9062-1410	Midfold 60 -Sürme Katlanır Kapı Sistemi / Sliding Foldable Heavy Door System	Gri / Grey	1 Kapı / 1 Kit	4	160	-	-
122-9061-1300-505	Çelik Menteşe / Steel Hinge	Galvaniz / Galvanized	1 Adet / 1 Pcs	50	2.400	-	-
122-9300-1300-509	Zemin Pivot Burcu Paslanmaz / Ground Pivot Stainless	Galvaniz / Galvanized	1 Adet / 1 Pcs	100	9.600	-	-
150-9065-1410	Alüminyum Üst Ray Profili / Aluminium Top Rail Profile	Eloksal / Mat Anodized	mt.	-	-	-	6,0 6 ad/pcs
150-9067-1410	Alüminyum Alt Klavuz / Aluminium Bottom Slider	Eloksal / Mat Anodized	mt.	-	-	-	6,0 10 ad/pcs

MasterFold 160

160 KG KATLANIR SÜRME KAPI SİSTEMİ • FOLDABLE DOOR MECHANISM - FOLDING DOOR



Bilgi / Information

- Minimum kapı panel kalınlığı 40 mm. olmalıdır.
- Door panel's thickness should be minimum 40 mm.



9300 1 Takım İçeriği / 1 Kit Includes

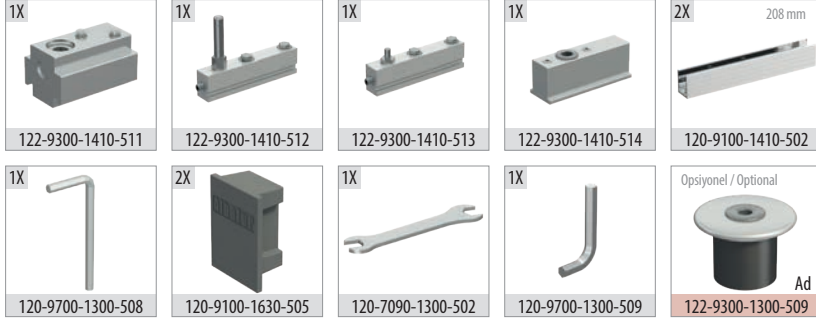

9400 1 Takım İçeriği / 1 Kit Includes

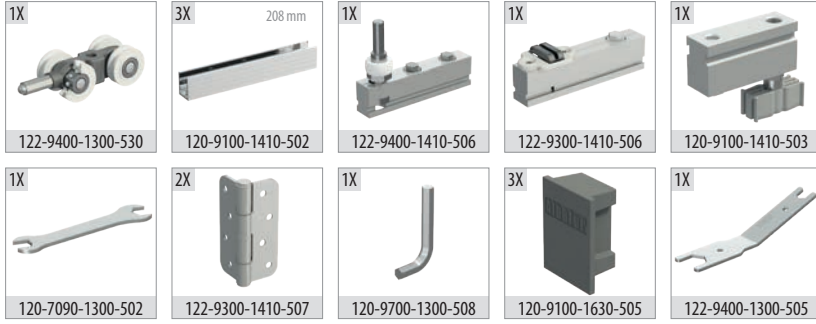

Ray Profilleri / Rail Profiles

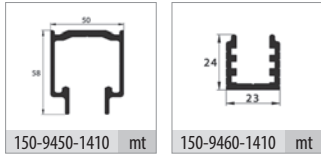

Opsiyonel / Optional

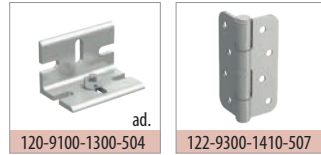

Uygulama / Application



Teknik Detay / Technical Detail

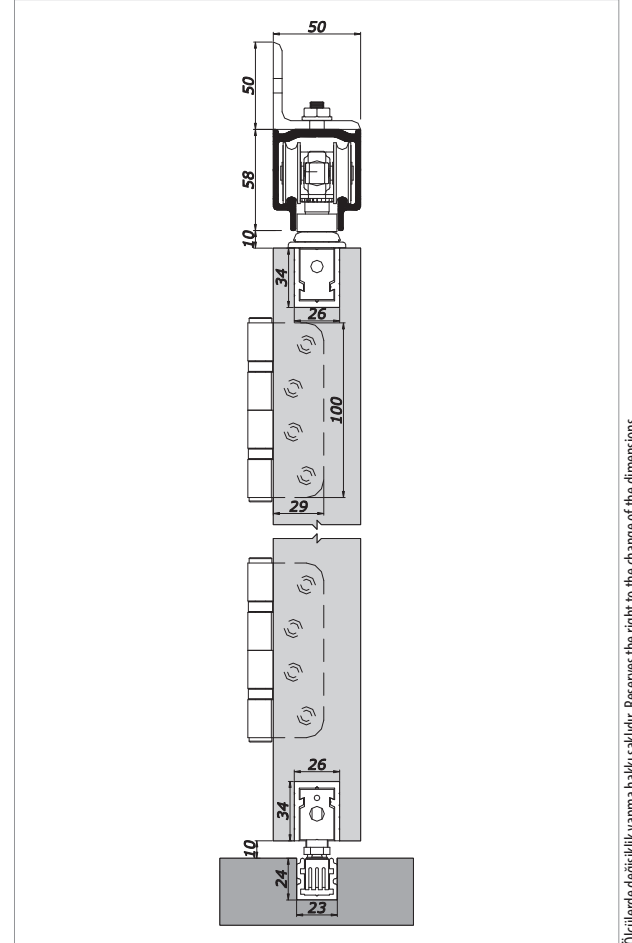

Ölçülerde değişiklik yapma hakkı saklıdır. Reserves the right to the change of the dimensions.

Kod / Code No	Açıklama / Description	Renk / Colour	Birim / Unit			Profil mt. / Profiles mt.			Bağ / Bnd.
122-9300-1410	Sabit Kanat / Foldable Heavy Door System	Gri / Grey	1 Kapı / 1 Kit	12	360	-	-	-	-
122-9400-1410	160 Kg Katlanır Kapı Sistemi / Foldable Heavy Door System	Gri / Grey	1 Kapı / 1 Kit	12	360	-	-	-	-
120-9100-1300-504	Aski Aparatı / Hanger Parts	Galvaniz / Galvanized	1 Adet / 1 Pcs	50	2.400	-	-	-	-
122-9300-1300-509	Zemin Pivot Burcu Paslanmaz / Ground Pivot Stainless	Galvaniz / Galvanized	1 Adet / 1 Pcs	100	9.600	-	-	-	-
150-9450-1410	Alüminyum Üst Ray Profili / Aluminium Top Rail Profile	Eloksal / Mat Anodized	mt.	-	-	2,0	3,0	6,0	2 ad/pcs
150-9460-1410	Alüminyum Alt Ray Profili / Aluminium Bottom Rail Profile	Eloksal / Mat Anodized	mt.	-	-	2,0	3,0	6,0	8 ad/pcs

MidFold 160

160 KG KATLANIR SÜRME KAPI SİSTEMİ • FOLDABLE DOOR MECHANISM - FOLDING DOOR



Bilgi / Information

- Minimum kapı panel kalınlığı 40 mm. olmalıdır.
- Door panel's thickness should be minimum 40 mm.



9300 1 Takım İçeriği / 1 Kit Includes

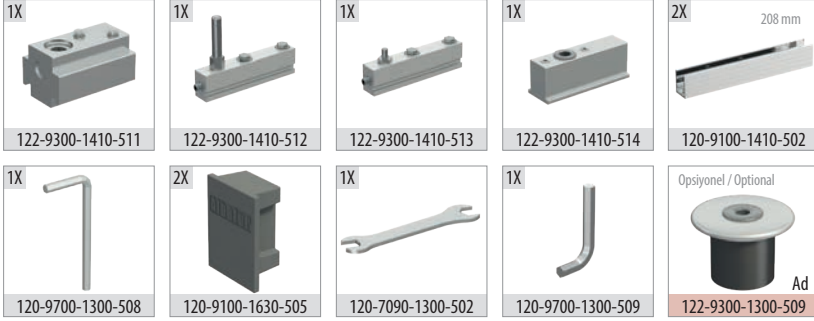

9500 1 Takım İçeriği / 1 Kit Includes

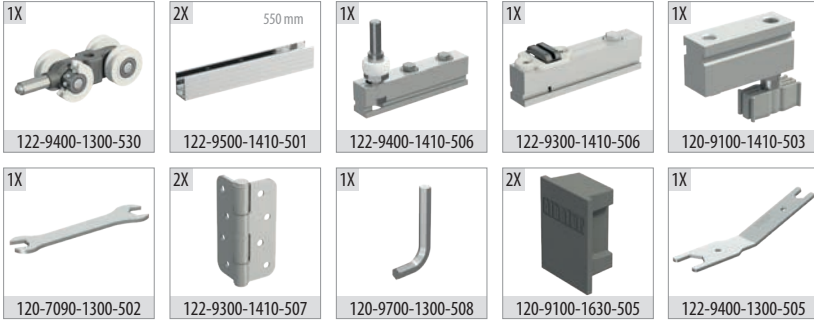

Ray Profilleri / Rail Profiles

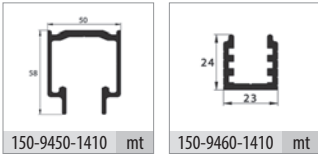

Opsiyonel / Optional

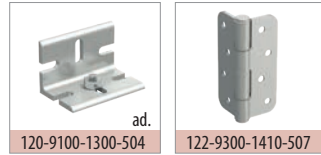

Uygulama / Application



Teknik Detay / Technical Detail

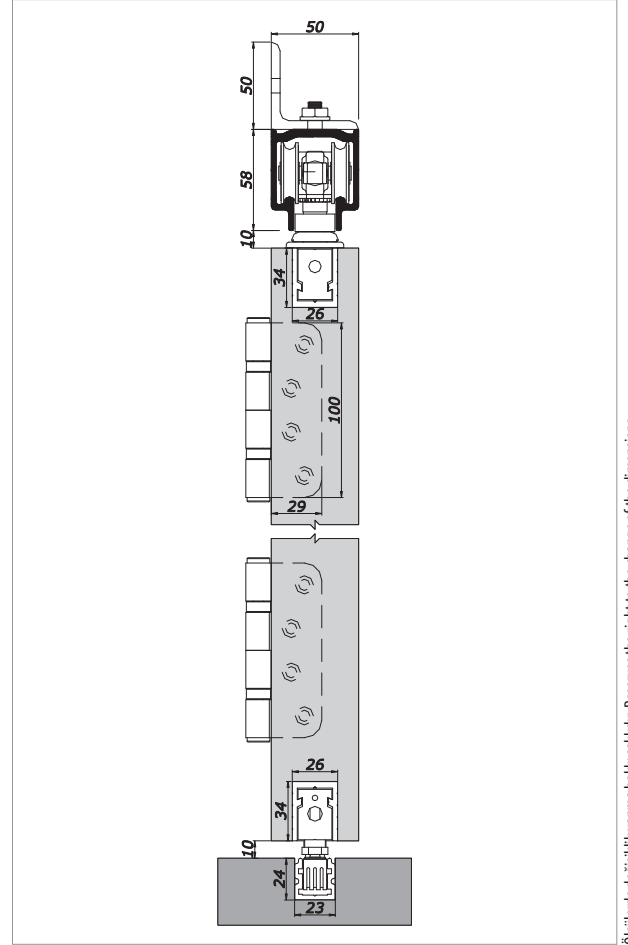

Ölçülerde değişiklik yapma hakkı saklıdır. Reserves the right to the change of the dimensions.

Kod / Code No	Açıklama / Description	Renk / Colour	Birim / Unit			Profil mt. / Profiles mt.			Bağ / Bnd.
122-9300-1410	Sabit Kanat / Foldable Heavy Door System	Gri / Grey	1 Kapı / 1 Kit	12	360	-	-	-	-
122-9500-1410	Katlanır Kapı Sistemi / Foldable Heavy Door System	Gri / Grey	1 Kapı / 1 Kit	4	160	-	-	-	-
120-9100-1300-504	Askı Aparatı / Hanger Parts	Galvaniz / Galvanized	1 Adet / 1 Pcs	50	2.400	-	-	-	-
122-9300-1300-509	Zemin Pivot Burcu Paslanmaz / Ground Pivot Stainless	Galvaniz / Galvanized	1 Adet / 1 Pcs	100	9.600	-	-	-	-
150-9450-1410	Alüminyum Üst Ray Profili / Aluminium Top Rail Profile	Eloksal / Mat Anodized	mt.	-	-	2,0	3,0	6,0	2 ad/pcs
150-9460-1410	Alüminyum Alt Ray Profili / Aluminium Bottom Rail Profile	Eloksal / Mat Anodized	mt.	-	-	2,0	3,0	6,0	8 ad/pcs

MasterFold 60

UYGULAMA ŞEMASI • APPLICATION SCHEME

MidFold 60

UYGULAMA ŞEMASI • APPLICATION SCHEME

	9060 - 1 Tk 9061 - 1 Tk		9060 - 1 Tk 9062 - 1 Tk
	9060 - 1 Tk 9061 - 1 Tk		9060 - 2 Tk 9062 - 1 Tk
	9060 - 2 Tk 9061 - 1 Tk		9060 - 1 Tk 9062 - 1 Tk
	9060 - 2 Tk 9061 - 1 Tk		9060 - 2 Tk 9062 - 1 Tk
	9060 - 1 Tk 9061 - 2 Tk		9060 - 1 Tk 9062 - 2 Tk
	9060 - 1 Tk 9061 - 2 Tk		9060 - 2 Tk 9062 - 2 Tk
	9060 - 2 Tk 9061 - 2 Tk		9060 - 1 Tk 9062 - 3 Tk
	9060 - 1 Tk 9061 - 3 Tk		9060 - 2 Tk 9062 - 2 Tk
	9060 - 2 Tk 9061 - 2 Tk		9060 - 1 Tk 9062 - 3 Tk
	9060 - 1 Tk 9061 - 3 Tk		9060 - 2 Tk 9062 - 3 Tk
	9060 - 2 Tk 9061 - 3 Tk		9060 - 2 Tk 9062 - 2 Tk
	9060 - 2 Tk 9061 - 3 Tk		9060 - 2 Tk 9062 - 2 Tk
	9060 - 1 Tk 9061 - 3 Tk		9060 - 2 Tk 9062 - 3 Tk
	9060 - 2 Tk 9061 - 3 Tk		9060 - 2 Tk 9062 - 2 Tk
	9060 - 2 Tk 9061 - 3 Tk		9060 - 2 Tk 9062 - 2 Tk
	9060 - 2 Tk 9061 - 2 Tk		9060 - 2 Tk 9062 - 4 Tk
	9060 - 2 Tk 9061 - 2 Tk		9060 - 2 Tk 9062 - 4 Tk
	9060 - 2 Tk 9061 - 4 Tk		9060 - 2 Tk 9062 - 6 Tk
	9060 - 2 Tk 9061 - 4 Tk		9060 - 2 Tk 9062 - 6 Tk
	9060 - 2 Tk 9061 - 6 Tk		
	9060 - 2 Tk 9061 - 6 Tk		

- Yüksekliği 2.100 mm olan kanatlarda, kapı başına 2 adet menteşe kullanılmalıdır.
- Yüksekliği 2.100 - 2.500 mm'ye kadar kanatlarda, kapı başına 3 adet menteşe kullanılmalıdır.
- Yüksekliği 2.500 - 2.700 mm'ye kadar kanatlarda, kapı başına 4 adet menteşe önerilir.
- Minimum kapı genişliği 380 mm olmalıdır.
- Maksimum kapı genişliği 900 mm olmalıdır.
- Minimum ahşap kapı panel kalınlığı 36 mm olmalıdır.
- Alüminyum Profil kanatlarda min. kapı panel kalınlığı 25 mm olmalıdır.
- Maksimum yükseklik 2.700 mm olmalıdır.
- Montaj esnasında uygulamaya göre ilave menteşe talep edilebilir.













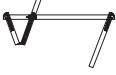
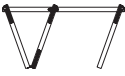











- 2.100 mm in height for doors, should be used 2 pcs hinge per door.
- Up to 2.100 - 2.500 mm in height for doors, 3 hinges should be used per door.
- Up to 2.500 - 2.700 mm in height for doors, 4 hinges should be used per door.
- Min. door width 380 mm
- Max. door width 900 mm
- Door panel's thickness should be min. 36 mm
- The minimum thickness should be 25mm on aluminum profile panel doors.
- Max. door height 2.700 mm
- An additional hinge steel hinge can be requested during the assembly.

MasterFold 160

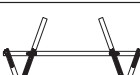
UYGULAMA ŞEMASI • APPLICATION SCHEME

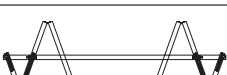
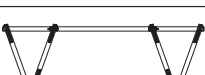
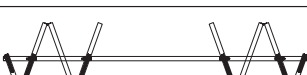
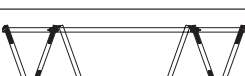
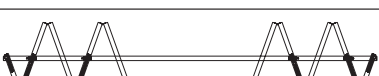
MidFold 160

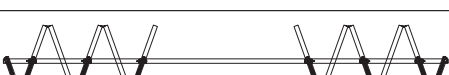
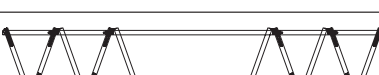
UYGULAMA ŞEMASI • APPLICATION SCHEME

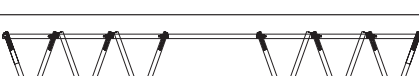
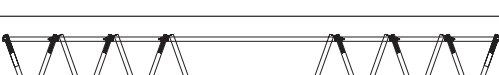
	9300 - 1 Tk. 9400 - 1 Tk.		9300 - 1 Tk. 9500 - 1 Tk.
	9300 - 1 Tk. 9400 - 1 Tk.		9300 - 2 Tk. 9500 - 1 Tk.
	9300 - 2 Tk. 9400 - 1 Tk.		9300 - 1 Tk. 9500 - 1 Tk.
	9300 - 2 Tk. 9400 - 1 Tk.		9300 - 2 Tk. 9500 - 1 Tk.
	9300 - 1 Tk. 9400 - 2 Tk.		9300 - 1 Tk. 9500 - 2 Tk.
	9300 - 1 Tk. 9400 - 2 Tk.		9300 - 2 Tk. 9500 - 2 Tk.
	9300 - 2 Tk. 9400 - 2 Tk.		9300 - 1 Tk. 9500 - 3 Tk.
	9300 - 1 Tk. 9400 - 3 Tk.		9300 - 2 Tk. 9500 - 2 Tk.
	9300 - 2 Tk. 9400 - 2 Tk.		9300 - 1 Tk. 9500 - 3 Tk.
	9300 - 1 Tk. 9400 - 3 Tk.		9300 - 2 Tk. 9500 - 3 Tk.
	9300 - 2 Tk. 9400 - 3 Tk.		9300 - 2 Tk. 9500 - 2 Tk.
	9300 - 2 Tk. 9400 - 3 Tk.		9300 - 2 Tk. 9500 - 2 Tk.
	9300 - 2 Tk. 9400 - 2 Tk.		9300 - 2 Tk. 9500 - 4 Tk.
	9300 - 2 Tk. 9400 - 2 Tk.		9300 - 2 Tk. 9500 - 4 Tk.
	9300 - 2 Tk. 9400 - 4 Tk.		9300 - 2 Tk. 9500 - 6 Tk.
	9300 - 2 Tk. 9400 - 4 Tk.		9300 - 2 Tk. 9500 - 6 Tk.
	9300 - 2 Tk. 9400 - 6 Tk.		
	9300 - 2 Tk. 9400 - 6 Tk.		

* Yüksekliği 2500 mm olan kanatlarda, kapı başına 2 adet 122-9300-1410-507 kullanılmalıdır.

* Yüksekliği 2500 mm'den büyük kanatlarda, kapı başına 3 adet 122-9300-1410-507 kullanılmalıdır.

* Minimum kapı genişliği 550 mm olmalıdır.

* Maksimum kapı genişliği 950 mm olmalıdır.

* Minimum kapı panel kalınlığı 40 mm olmalıdır.

* Maksimum yükseklik 2.700 mm olmalıdır.

* Montaj esnasında uygulamaya göre ilave 122-9300-1410-507 menteşe talep edilebilir.

* 2500 mm in height for doors, should be used 2 pcs 122-9300-1410-507 per door

* More than height 2500 mm for doors, should be used 3 pcs 122-9300-1410-507 per door

* Min. door width 550 mm

* Max. door width 950 mm

* Door panel's thickness should be min. 40 mm

* Max. door height 2.700 mm

* An additional 122-9300-1410-507 steel hinge can be requested during the assembly.

GlassDoor 9900

120 KG SÜRGÜ CAM KAPI SİSTEMİ • SLIDING GLASS DOOR SYSTEM

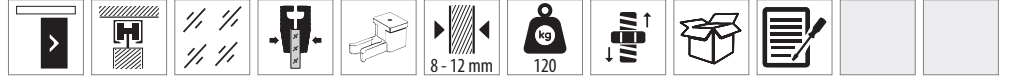

9900 1 Takım İçeriği / 1 Kit Includes

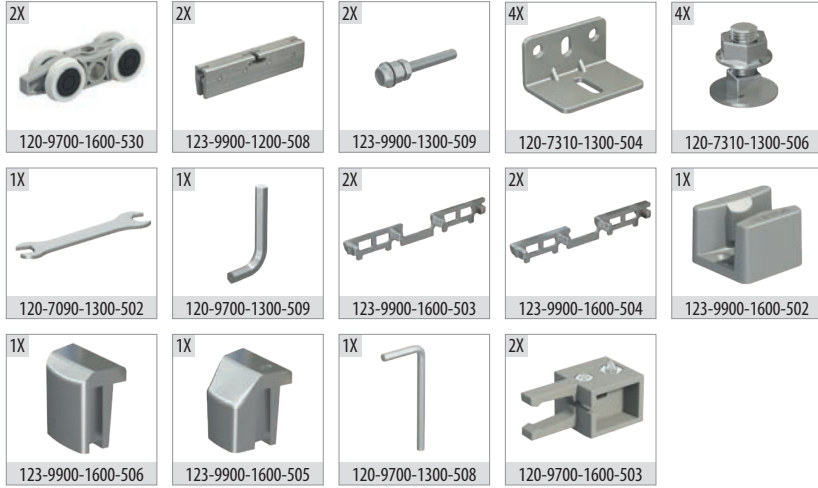

Ray Profilleri / Rail Profiles

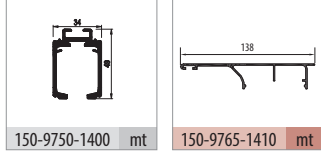

Uygulama / Application



Teknik Detay / Technical Detail

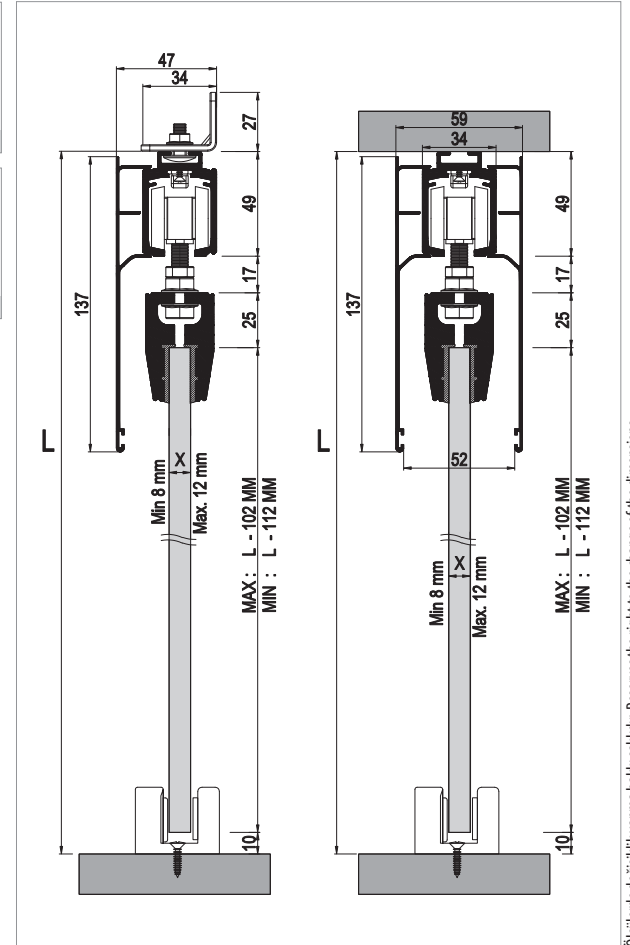

Ölçülerde değişiklik yapma hakkı saklıdır. Reserves the right to the change of the dimensions.

Kod / Code No	Açıklama / Description	Renk / Colour	Birim / Unit			Profil mt. / Profiles mt.			Bağ / Bnd.
123-9900-1200	120 Kg Sürgü Cam Kapı Sistemi / Sliding Glass Door System	Gri / Grey	1 Kapı / 1 Kit	12	216	-	-	-	-
150-9750-1400	Alüminyum Üst Ray Profili / Aluminium Top Rail Profile	Pres / Uncoated	mt	-	-	2,0	-	3,0	2 ad/pcs
150-9765-1410	Alüminyum Alın Kapama / Aluminium Cover Front	Eloksal / Mat Anodized	mt	-	-	2,0	-	3,0	2 ad/pcs

GlassDoor 9921

120 KG ÇİFT YÖNE YAVAŞLATICILI SÜRGÜ CAM KAPI SİSTEMİ • GLASS SLIDING DOOR SYSTEM TWO WAY SOFT CLOSING

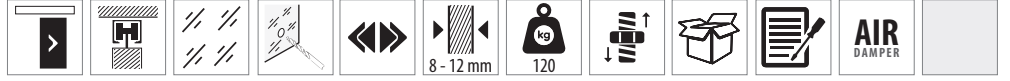

Bilgi / Information

- Minimum kapı genişliği 870 mm olmalıdır.
- Bu ürün camda delme işlemi gerektirmektedir.
- Min. Door width 870 mm
- This product need drilling on the glass.

Yavaşlatıcı Alternatifi / Soft Closer Alternative

- Sistem üzerinde çift yöne yavaşlatıcı mevcuttur.
- The system has two way soft closing.



9921 1 Takım İçeriği / 1 Kit Includes

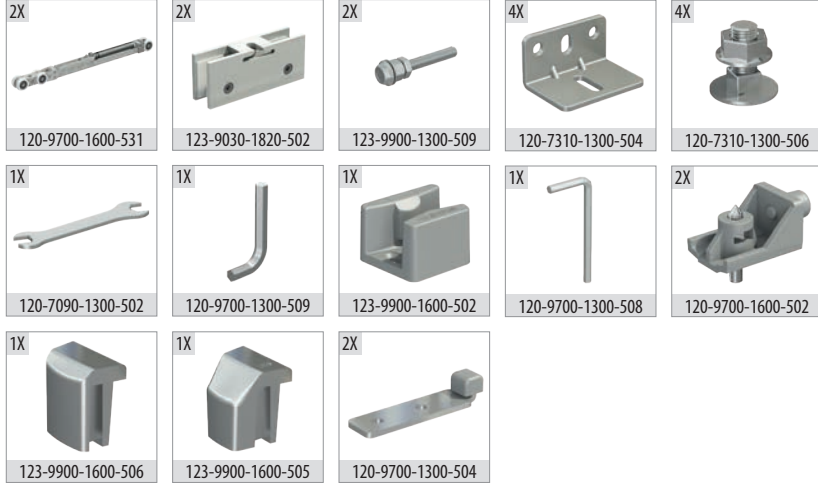

Ray Profilleri / Rail Profiles

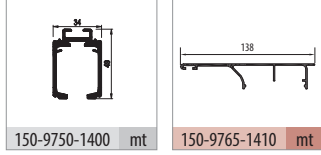

Uygulama / Application



Teknik Detay / Technical Detail

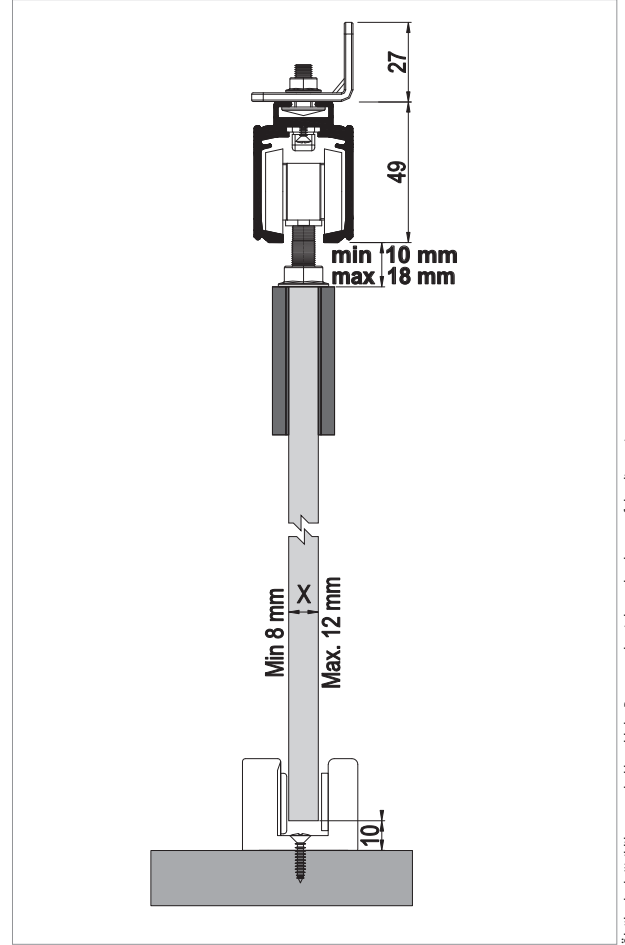

Ölçülerde değişiklik yapma hakkı saklıdır. Reserves the right to the change of the dimensions.

Kod / Code No	Açıklama / Description	Renk / Colour	Birim / Unit			Profil mt. / Profiles mt.			Bağ / Bnd.
123-9921-1820	120 Kg Yavaşlatıcılı Sürgü Cam Kapı Sistemi / Sliding Glass Door System Has Soft Closing	Gri / Grey	1 Kapı / 1 Kit	12	216	-	-	-	-
150-9750-1400	Alüminyum Üst Ray Profili / Aluminium Top Rail Profile	Pres / Uncoated	mt	-	-	2,0	-	3,0	2 ad/pcs
150-9765-1410	Alüminyum Alın Kapama / Aluminium Cover Front	Eloksal / Mat Anodized	mt	-	-	2,0	-	3,0	2 ad/pcs

GlassDoor 9030

60 KG ÇİFT YÖNE YAVAŞLATICILI SÜRME CAM KAPI SİSTEMİ • SLIDING GLASS DOOR SYSTEM - TWO WAY SOFT CLOSING

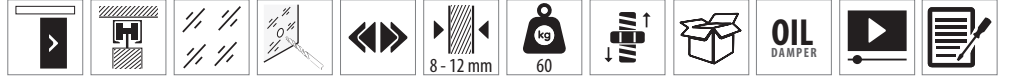

Bilgi / Information

- Minimum kapı genişliği 650 mm olmalıdır.
- Bu ürün camda delme işlemi gerektirmektedir.
- Min. Door width 650 mm
- This product need drilling on the glass.

Yavaşlatıcı Alternatifi / Soft Closer Alternative

- Sistem üzerinde çift yöne yavaşlatıcı mevcuttur.
- The system has two way soft closing.



9030 1 Takım İçeriği / 1 Kit Includes

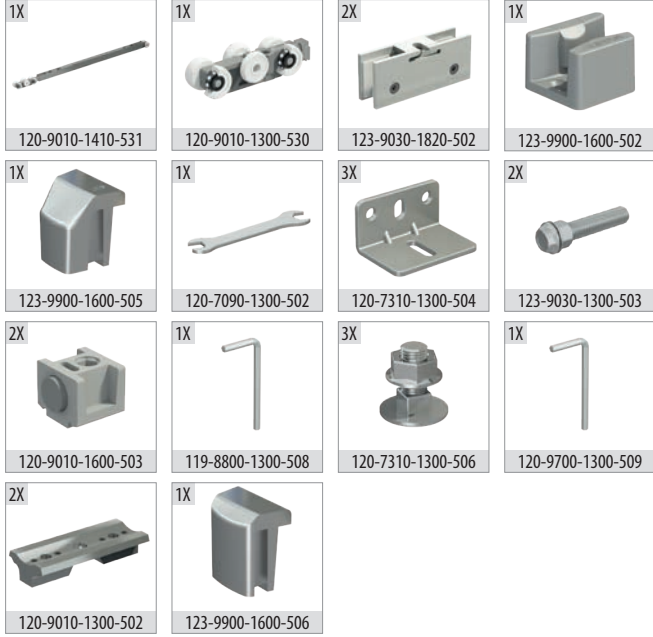

Ray Profilleri / Rail Profiles

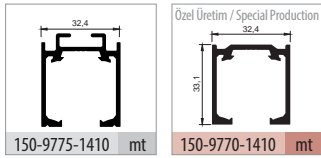

Uygulama / Application



Teknik Detay / Technical Detail

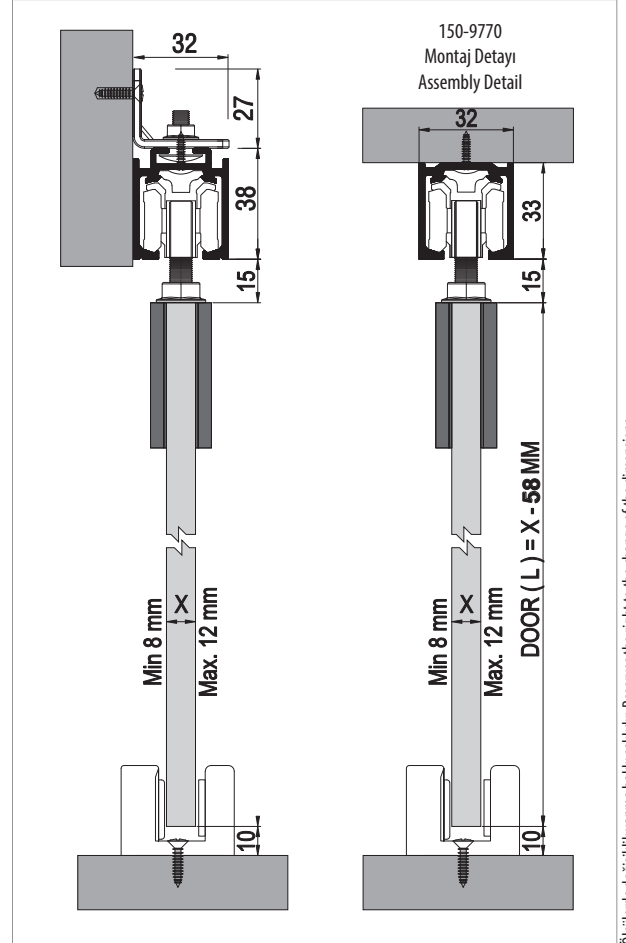

Ölçülerde değişiklik yapma hakkı saklıdır. Reserves the right to the change of the dimensions.

Kod / Code No	Açıklama / Description	Renk / Colour	Birim / Unit			Profil mt. / Profiles mt.	Bağ / Bnd.
123-9030-1820	60 Kg Yavaşlatıcılı Sürgü Cam Kapı Sistemi / Sliding Glass Door System Has Soft Closing	Gri / Grey	1 Kapı / 1 Kit	4	192	-	-
150-9775-1410	Alüminyum Üst Ray Profili / Aluminium Top Rail Profile	Eloksal / Mat Anodized	mt.	-	-	2,0 3,0	6 ad/pcs

GlassDoor 9035

60 KG ÇİFT YÖNE YAVAŞLATICILI SÜRME CAM KAPI SİSTEMİ • SLIDING GLASS DOOR SYSTEM - TWO WAY SOFT CLOSING



Bilgi / Information

- Minimum kapı genişliği 750 mm olmalıdır.
- Min. Door width 750 mm

Yavaşlatıcı Alternatifi / Soft Closer Alternative

- Sistem üzerinde çift yöne yavaşlatıcı mevcuttur.
- The system has two way soft closing.



9035 1 Takım İçeriği / 1 Kit Includes

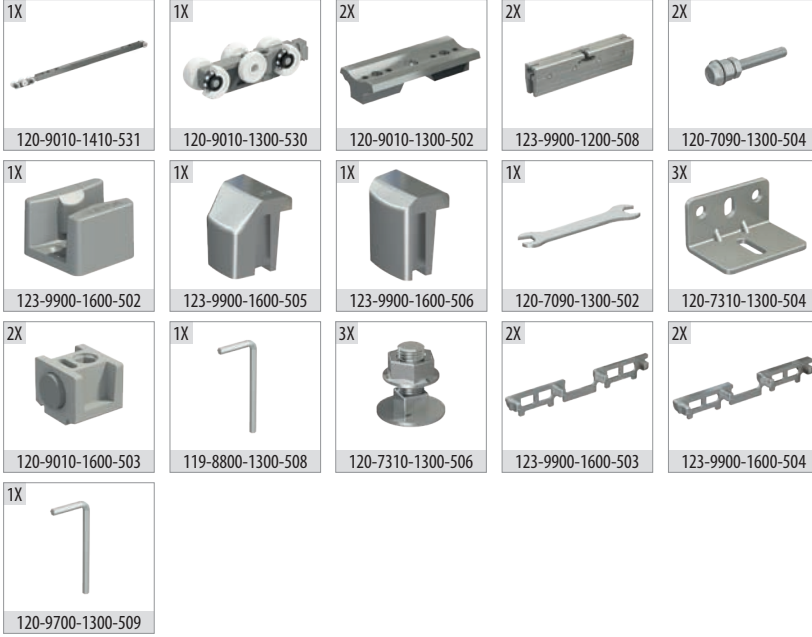

Ray Profilleri / Rail Profiles

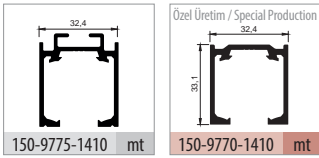

Uygulama / Application



Teknik Detay / Technical Detail

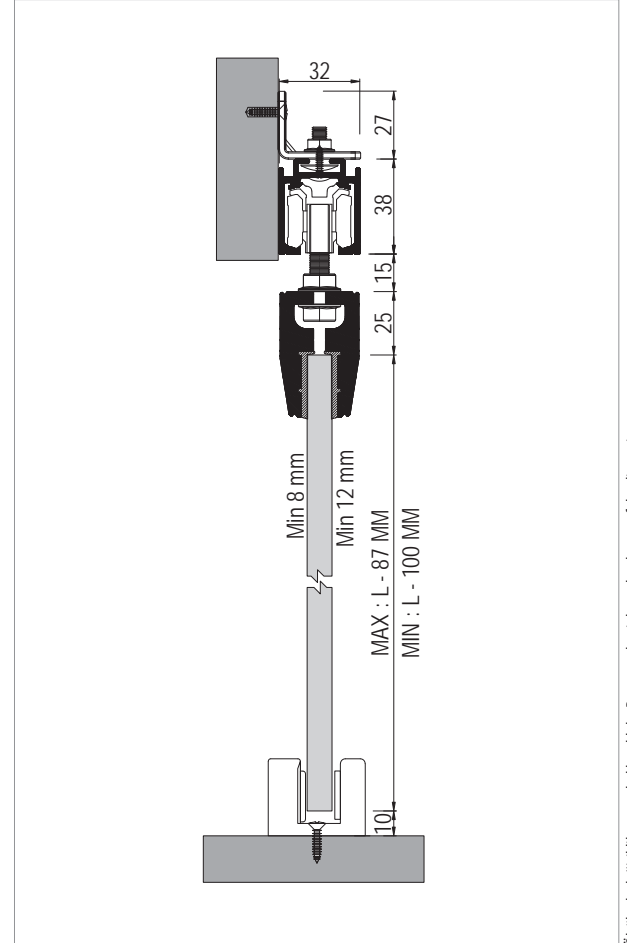

Ölçülerde değişiklik yapma hakkı saklıdır. Reserves the right to the change of the dimensions.

Kod / Code No	Açıklama / Description	Renk / Colour	Birim / Unit			Profil mt. / Profiles mt.	Bağ / Bnd.	
123-9035-1300	60 Kg Yavaşlatıcılı Sürgü Cam Kapı Sistemi / Sliding Glass Door System Has Soft Closing	Gri / Grey	1 Kapı / 1 Kit	4	192	-	-	-
150-9775-1410	Alüminyum Üst Ray Profili / Aluminium Top Rail Profile	Eloksal / Mat Anodized	mt.	-	-	2,0	3,0	-

DoorSync 9950

120 KG HALATLI SÜRGÜ CAM KAPI SİSTEMİ • FUNICULAR SLIDING GLASS DOOR SYSTEM

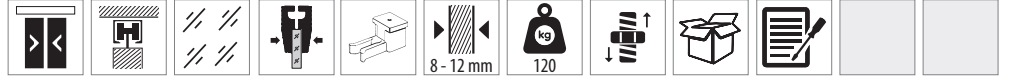
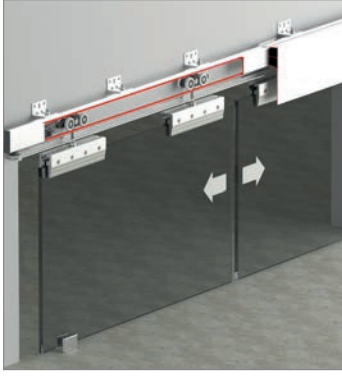

Bilgi / Information

- Minimum kapı genişliği 400 mm olmalıdır.
- Min. Door width 400 mm



9950 1 Set İçeriği / 1 Set Includes



Ray Profilleri / Rail Profiles



Uygulama / Application



Teknik Detay / Technical Detail

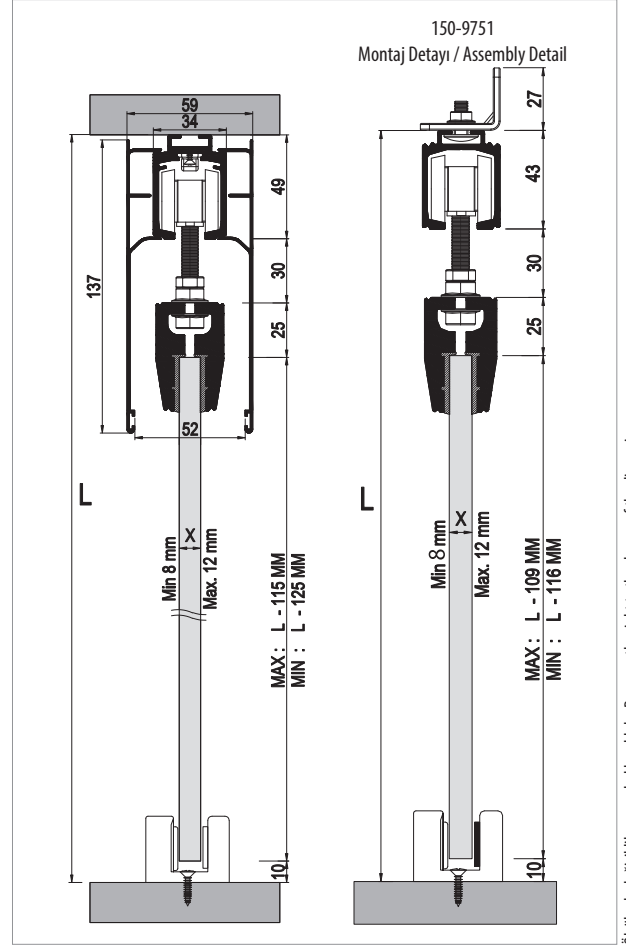

Ölçülerde değişiklik yapma hakkı saklıdır. Reserves the right to the change of the dimensions.

Kod / Code No	Açıklama / Description	Renk / Colour	Birim / Unit			Profil mt. / Profiles mt.	Bağ / Bnd.
124-9950-1200	120 Kg Senkronize Cam Kapı Sistemi / Funicular Glass Door System	Gri / Grey	2 Kapı / 1 Set	1	100	-	-
150-9750-1400	Alüminyum Üst Ray Profili / Aluminium Top Rail Profile	Pres / Uncoated	mt	-	-	3,0 4,0 6,0	2 ad/pcs
150-9751-1400	Alüminyum Üst Ray Profili / Aluminium Top Rail Profile	Pres / Uncoated	mt	-	-	3,0 4,0 6,0	2 ad/pcs
150-9765-1410	Alüminyum Alın Kapama / Aluminium Cover Front	Eloksal / Mat Anodized	mt	-	-	3,0 4,0 6,0	2 ad/pcs

DoorSync 9960

120 KG ÇİFT YÖNE YAVAŞLATICILI HALATLI SÜRGÜ CAM KAPI SİSTEMİ • FUNICULAR SLIDING GLASS DOOR SYSTEM - HAS SOFT CLOSING

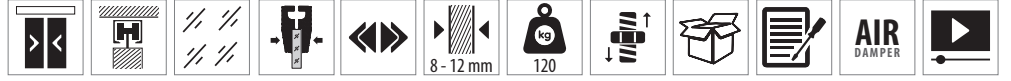
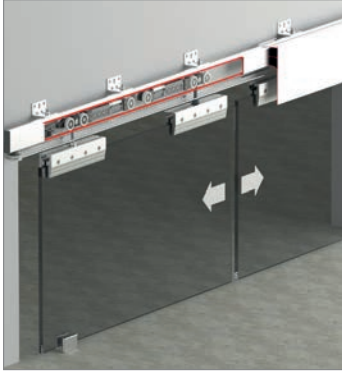

Bilgi / Information

- Minimum kapı genişliği 900 mm olmalıdır.
- Min. Door width 900 mm

Yavaşlatıcı Alternatifi / Soft Closer Alternative

- Sistem üzerinde çift yöne yavaşlatıcı mevcuttur.
- The system has two way soft closing.



9960 1 Set İçeriği / 1 Set Includes

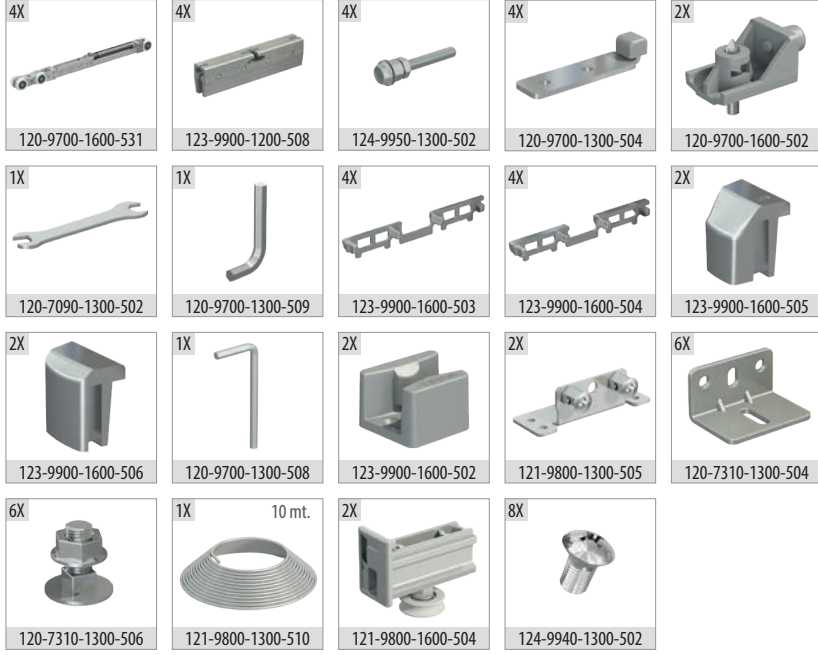

Ray Profilleri / Rail Profiles

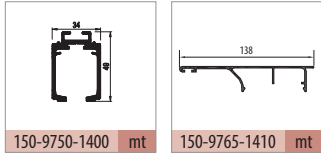

Uygulama / Application



Teknik Detay / Technical Detail

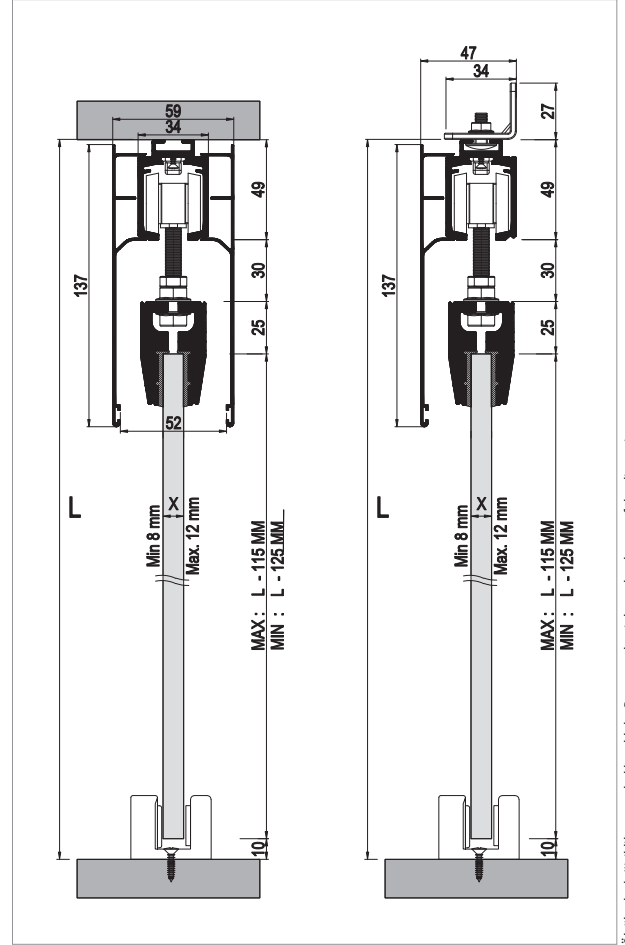

Ölçülerde değişiklik yapma hakkı saklıdır. Reserves the right to the change of the dimensions.

Kod / Code No	Açıklama / Description	Renk / Colour	Birim / Unit			Profil mt. / Profiles mt.			Bağ / Bnd.
124-9960-1200	120 Kg Yavaşlatıcılı Senkronize Cam Kapi Sistemi / Funicular Glass Door System	Gri / Grey	2 Kapi / 1 Set	1	100	-	-	-	-
150-9750-1400	Alüminyum Üst Ray Profili / Aluminium Top Rail Profile	Pres / Uncoated	mt	-	-	3,0	4,0	6,0	2 ad/pcs
150-9765-1410	Alüminyum Alın Kapama / Aluminium Cover Front	Eloksal / Mat Anodized	mt	-	-	3,0	4,0	6,0	2 ad/pcs

MultiDoor 100

80 KG TELESKOPIK SÜRME KAPI SİSTEMİ • TELESCOPIC SLIDING DOOR SYSTEMS

Yeni Ürün
New Product

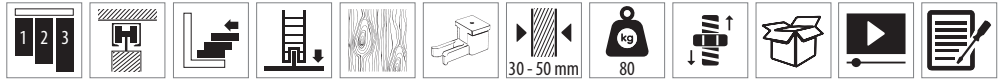

Bilgi / Information

- Minimum kapı genişliği 400 mm olmalıdır.
- Min. Door width 400 mm



MultiDoor 102 1 Set İçeriği / 1 Set Includes

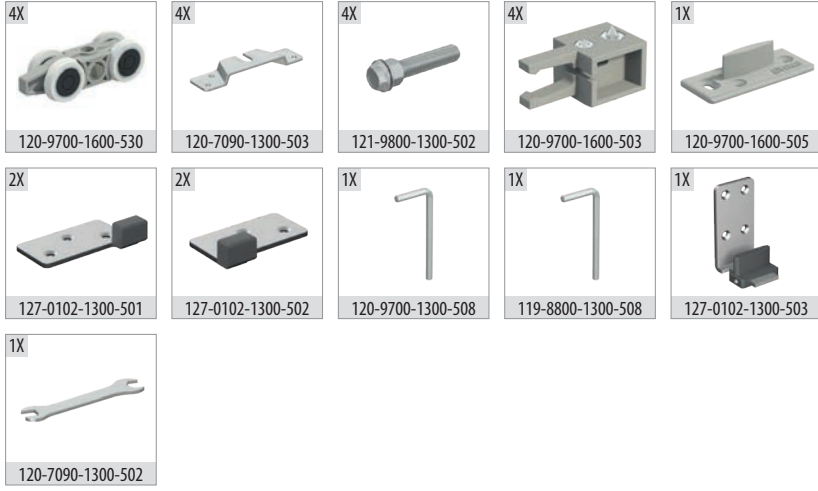

MultiDoor 101 1 Takım İçeriği (Opsiyonel Ek Kapı) / 1 Kit Includes (Optional Additional Door)

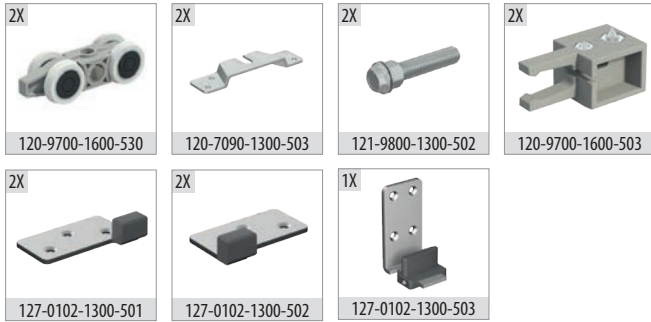

Ray Profilleri / Rail Profiles

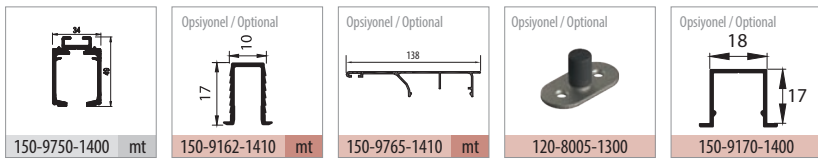

Teknik Detay / Technical Detail

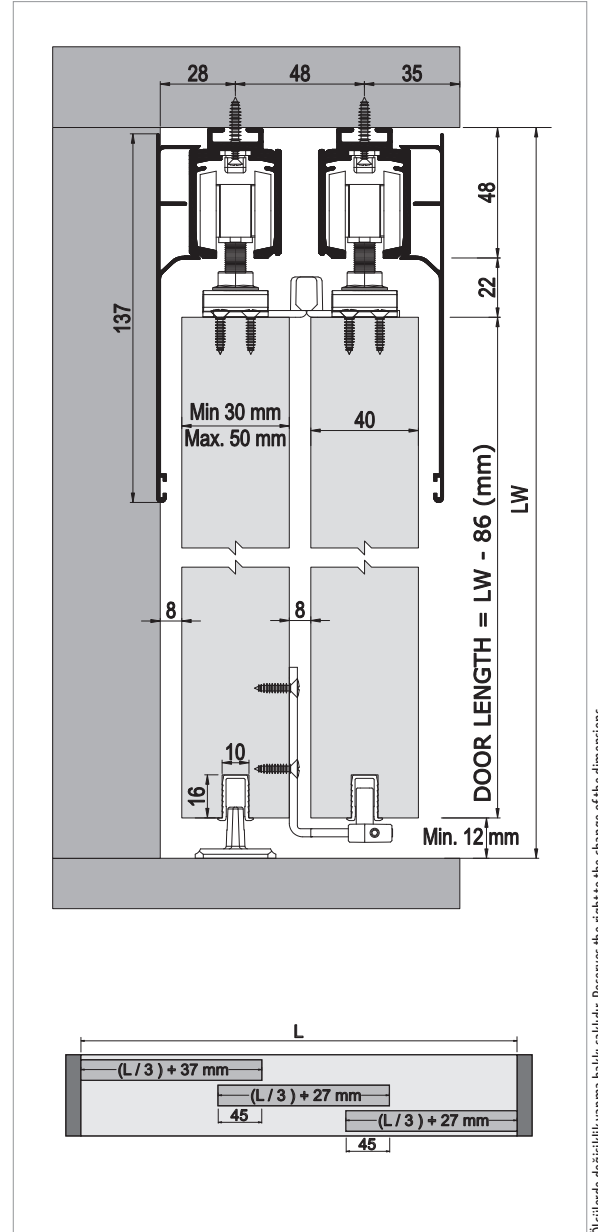

Ölçülerde değişiklik yapma hakkı saklıdır. Reserves the right to the change of the dimensions.

Kod / Code No	Açıklama / Description	Renk / Colour	Birim / Unit			Profil mt. / Profiles mt.	Bağ / Bnd.
127-0102-1600	MultiDoor 102 Teleskopik Sürme Kapı Sistemi / Telescopic Sliding Door System	Gri / Grey	2 Kapı / 1 Set	16	512	- - -	-
127-0101-1600	MultiDoor 101 İlave Kapı Sistemi / Additional Door System	Gri / Grey	1 Kapı / 1 Kit	24	576	- - -	-
150-9750-1400	Alüminyum Üst Ray Profili / Aluminium Top Rail Profile	Pres / Uncoated	mt.	-	-	- - 6,0	2 ad/pcs
150-9162-1410	Alüminyum Alt Klavuz Profili / Aluminium Bottom Slider Profile	Eloksal / Mat Anodized	mt.	-	-	- 3,0 6,0	20 ad/pcs
150-9765-1410	Alüminyum Alın Kapama / Aluminium Cover Front	Eloksal / Mat Anodized	mt.	-	-	2,0 3,0 6,0	2 ad/pcs

MultiDoor 150

80 KG TELESKOPİK HALATLI SÜRME KAPI SİSTEMİ • TELESCOPIC SLIDING DOOR SYSTEMS

Yeni Ürün
New Product

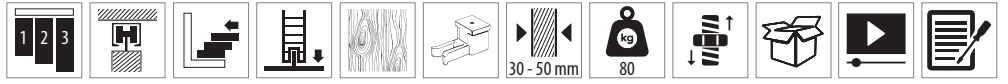

Bilgi / Information

- Minimum kapı genişliği 450 mm olmalıdır.
- Min. Door width 450 mm



MultiDoor 152 1 Set İçeriği / 1 Set Includes



MultiDoor 151 1 Takım İçeriği (Opsiyonel Ek Kapı) / 1 Kit Includes (Optional Additional Door)

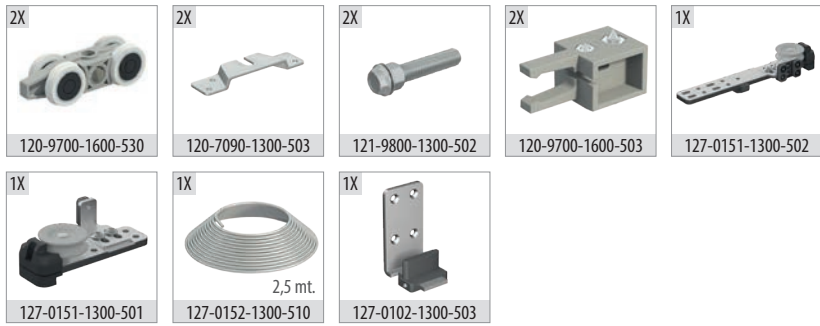

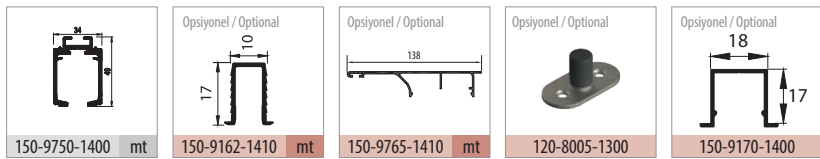

Ray Profilleri / Rail Profiles

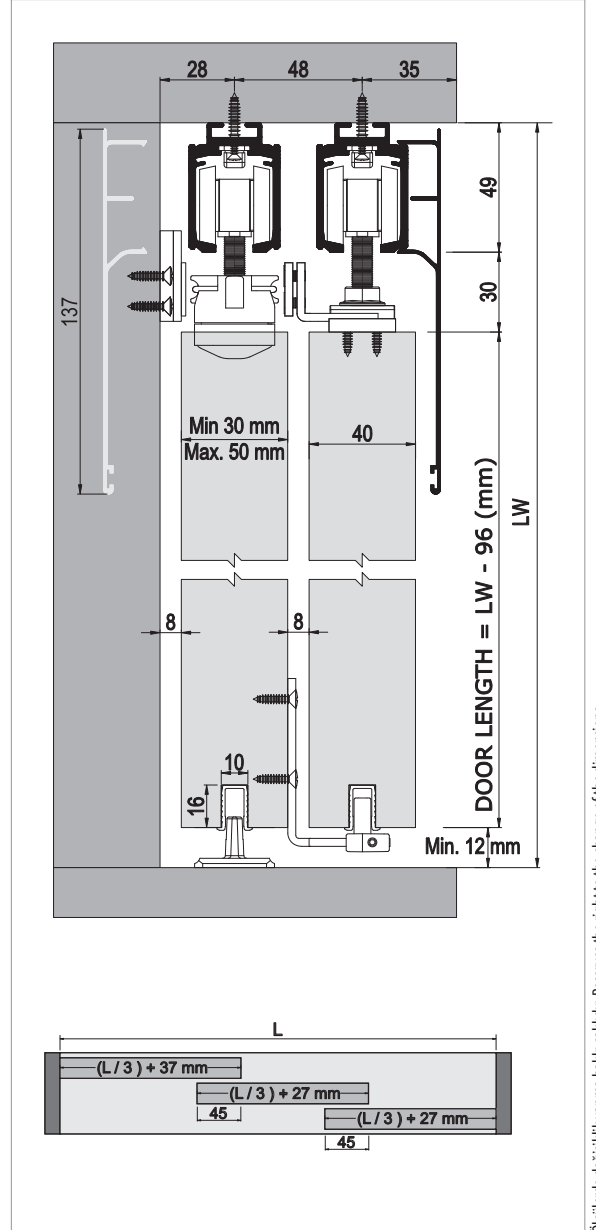

Teknik Detay / Technical Detail



Özelliklerde değişiklik yapma hakkı saklıdır. Reserves the right to the change of the dimensions.

Kod / Code No	Açıklama / Description	Renk / Colour	Birim / Unit			Profil mt. / Profiles mt.	Bağ / Bnd.
127-0152-1600	MultiDoor 152 Teleskopik Sürme Kapı Sistemi / Telescopic Sliding Door System	Gri / Grey	2 Kapı / 1 Set	12	360	-	-
127-0151-1600	MultiDoor 151 İlave Kapı Sistemi / Additional Door System	Gri / Grey	1 Kapı / 1 Kit	16	512	-	-
127-0152-1300-510	İlave Çelik Halat / Additional Wire Rope	Gri / Grey	mt.	-	-	-	-
150-9750-1400	Alüminyum Üst Ray Profili / Aluminium Top Rail Profile	Pres / Uncoated	mt.	-	-	-	6,0 2 ad/pcs
150-9162-1410	Alüminyum Alt Klavuz Profili / Aluminium Bottom Slider Profile	Eloksal / Mat Anodized	mt.	-	-	3,0 6,0	20 ad/pcs
150-9765-1410	Alüminyum Alın Kapama / Aluminium Cover Front	Eloksal / Mat Anodized	mt.	-	-	2,0 3,0 6,0	2 ad/pcs

MultiDoor 250

80 KG TEK YÖNE YAVAŞLATICILI HALATLI TELESKOPİK SÜRME KAPI SİSTEMİ - SOFTLINE TELESCOPIC SLIDING DOOR SYSTEMS

Yeni Ürün
New Product



Bilgi / Information

- Minimum kapı genişliği 670 mm olmalıdır.
- Min. Door width 670 mm

Yavaşlatıcı Alternatifi / Soft Closer Alternative

- Sistem üzerinde tek yöne yavaşlatıcı mevcuttur.
- The system has one way soft closing.



MultiDoor 252 1 Set İçeriği / 1 Set Includes

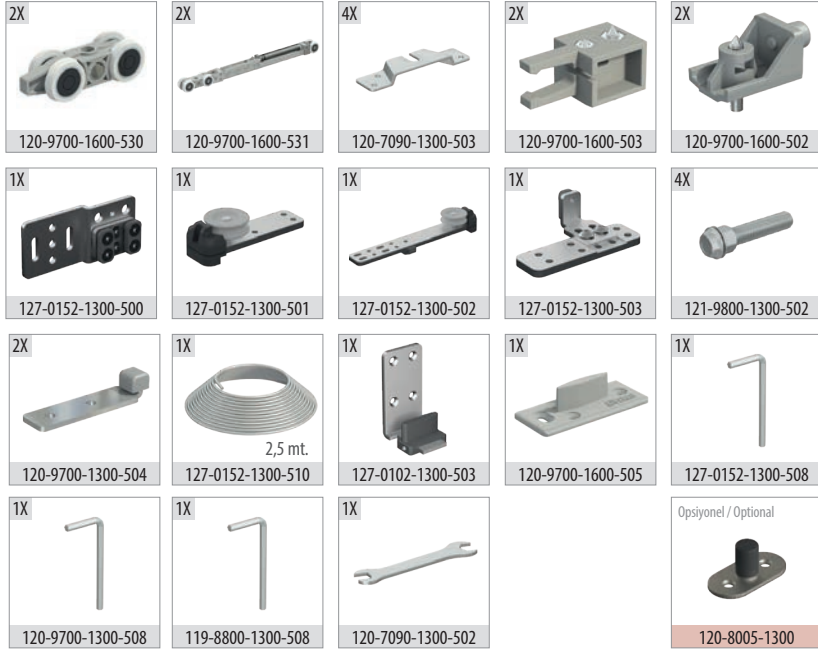

MultiDoor 251 1 Takım İçeriği (Opsiyonel Ek Kapı) / 1 Kit Includes (Optional Additional Door)

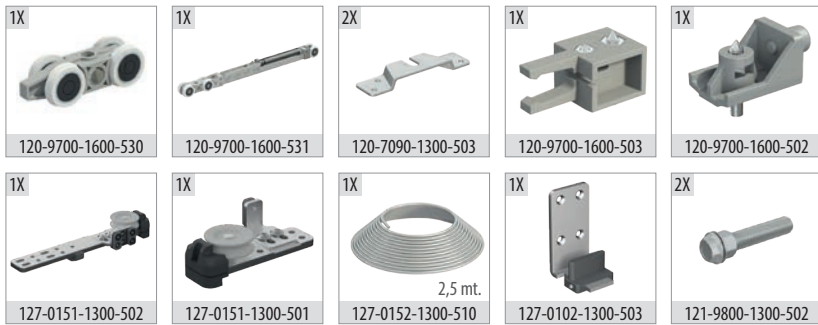

Ray Profilleri / Rail Profiles

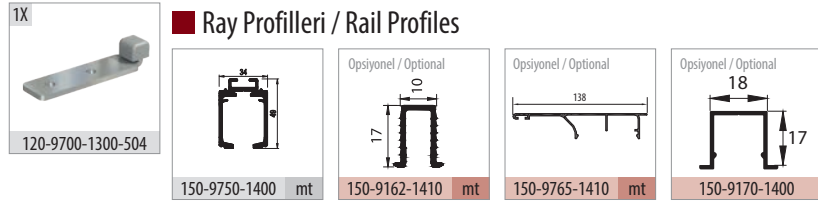

Teknik Detay / Technical Detail

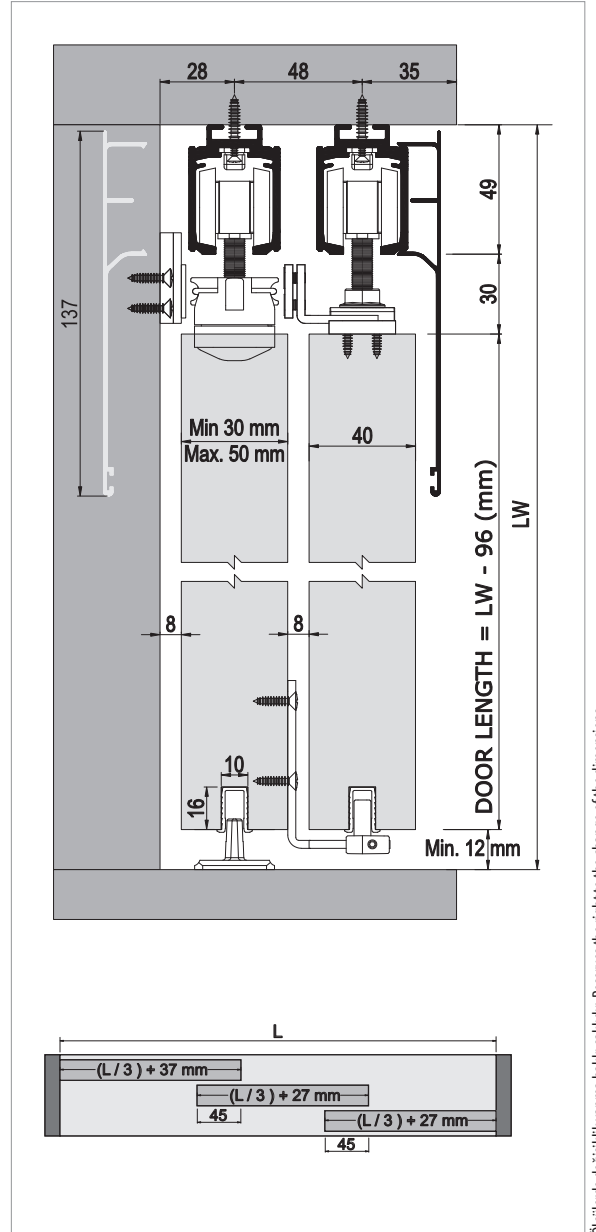

Ölçülerde değişiklik yapma hakkı saklıdır. Reserves the right to the change of the dimensions.

Kod / Code No	Açıklama / Description	Renk / Colour	Birim / Unit			Profil mt. / Profiles mt.	Bağ / Bnd.
127-0252-1600	MultiDoor 252 Teleskopik Sürme Kapı Sistemi / Telescopic Sliding Door System	Gri / Grey	2 Kapı / 1 Set	12	216	-	-
127-0251-1600	MultiDoor 251 İlave Kapı Sistemi / Additional Door System	Gri / Grey	1 Kapı / 1 Kit	8	400	-	-
127-0152-1300-510	İlave Çelik Halat / Additional Wire Rope	Gri / Grey	mt.	-	-	-	-
150-9750-1400	Alüminyum Üst Ray Profili / Aluminium Top Rail Profile	Pres / Uncoated	mt.	-	-	2,0 3,0 6,0	2 ad/pcs
150-9162-1410	Alüminyum Alt Klavuz Profili / Aluminium Bottom Slider Profile	Eloksal / Mat Anodized	mt.	-	-	- 3,0 6,0	20 ad/pcs
150-9765-1410	Alüminyum Alın Kapama / Aluminium Cover Front	Eloksal / Mat Anodized	mt.	-	-	2,0 3,0 6,0	2 ad/pcs

MultiDoor 450

60 KG ÇİFT YÖNE YAVAŞLATICILI HALATLI TELESKOPİK SÜRME KAPI SİSTEMİ • SOFTLINE TELESCOPIC SLIDING DOOR SYSTEMS

Yeni Ürün
New Product



Bilgi / Information

- Minimum kapı genişliği 810 mm olmalıdır.
- Min. Door width 810 mm

Yavaşlatıcı Alternatifi / Soft Closer Alternative

- Sistem üzerinde çift yöne yavaşlatıcı mevcuttur.
- The system has two way soft closing.



MultiDoor 452 1 Set İçeriği / 1 Set Includes



MultiDoor 451 1 Takım İçeriği (Opsiyonel Ek Kapı) / 1 Kit Includes (Optional Additional Door)

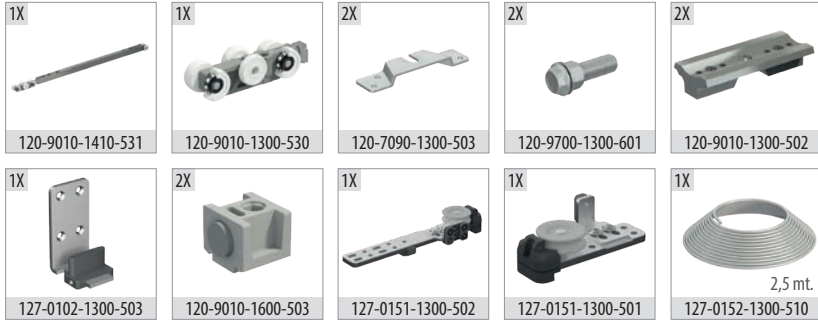

Ray Profilleri / Rail Profiles

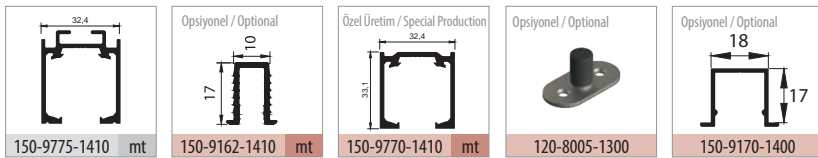

Teknik Detay / Technical Detail

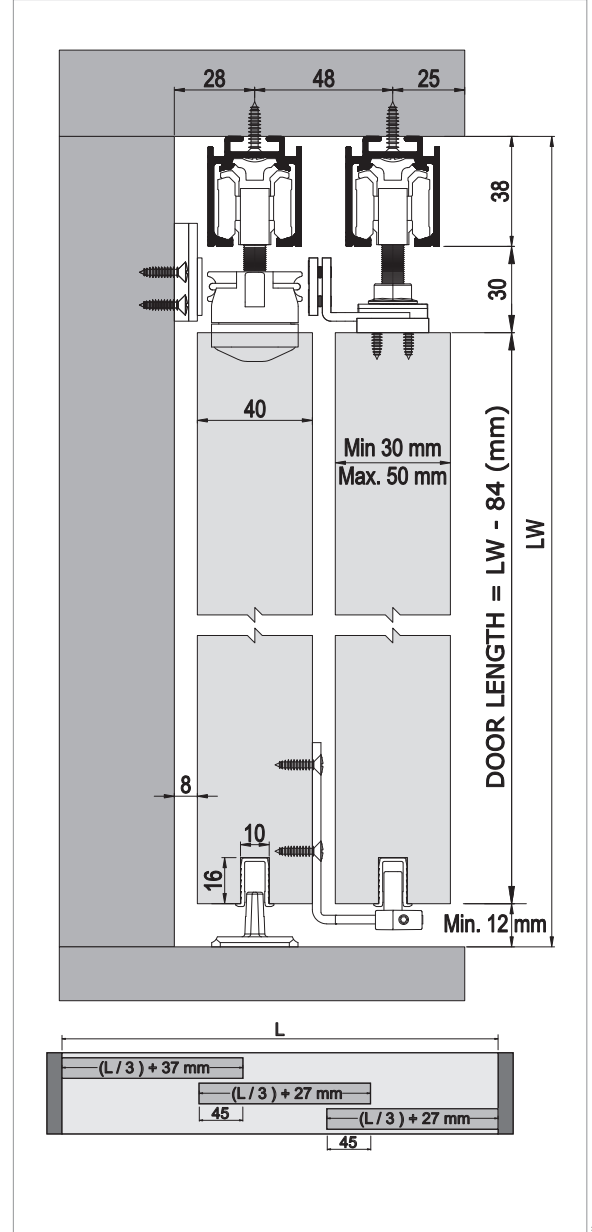

Ölçülerde değişiklik yapma hakkı saklıdır. Reserves the right to the change of the dimensions.

Kod / Code No	Açıklama / Description	Renk / Colour	Birim / Unit			Profil mt. / Profiles mt.	Bağ / Bnd.
127-0452-1410	MultiDoor 452 Teleskopik Sürme Kapı Sistemi / Telescopic Sliding Door System	Gri / Grey	2 Kapı / 1 Set	4	144	- - -	-
127-0451-1410	MultiDoor 451 İlave Kapı Sistemi / Additional Door System	Gri / Grey	1 Kapı / 1 Kit	4	144	- - -	-
127-0152-1300-510	İlave Çelik Halat / Additional Wire Rope	Gri / Grey	mt.	-	-	- - -	-
150-9775-1410	Alüminyum Üst Ray Profili / Aluminium Top Rail Profile	Eloksal / Mat Anodized	mt.	-	-	3,0 4,0 6,0	6 ad/pcs
150-9162-1410	Alüminyum Alt Klavuz Profili / Aluminium Bottom Slider Profile	Eloksal / Mat Anodized	mt.	-	-	- 3,0 6,0	20 ad/pcs
150-9770-1410	Alüminyum Üst Ray Profili / Aluminium Top Rail Profile	Eloksal / Mat Anodized	mt.	-	-	- - 6,0	6 ad/pcs

Underline

KAPI ALTI GIYOTINI SERİSİ • DOOR SEAL SERIES

Underline 200 • KAPI ALTI GIYOTINI • DOOR SEAL

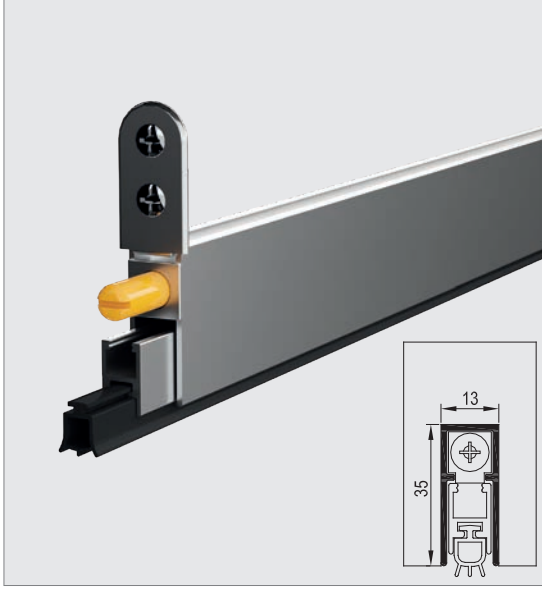

Bilgi / Information

- 0'dan 20 mm alt açıklığa kadar kapatabilme imkanı sunar.
- Mekanizma baskı ayarı yapılabilir.
- 10 cm. kadar kısaltma yapılabilir.
- Özel ölçü için lütfen müşteri temsilciniz ile irtibata geçiniz.
- Özel üretimlerde Minimum 200 adet sipariş kabul edilir.

- Usable for 0 - 20 mm drop
- Pressure can be adjusted
- Shortened up to 10 cm.
- Custom sizes, please contact your customer representative.
- Minimum 200 pcs orders are accepted in for special manufacturers.



Kod / Code No	Açıklama / Description	Boy / Size	Birim / Unit
130-0200-1410-0530	Kapı Altı Giyotini / Door Seal - Internal	530 mm	1 Adet / 1 Pcs
130-0200-1410-0830	Kapı Altı Giyotini / Door Seal - Internal	830 mm	1 Adet / 1 Pcs
130-0200-1410-0930	Kapı Altı Giyotini / Door Seal - Internal	930 mm	1 Adet / 1 Pcs
130-0200-1410-1030	Kapı Altı Giyotini / Door Seal - Internal	1.030 mm	1 Adet / 1 Pcs
130-0200-1410-1130	Kapı Altı Giyotini / Door Seal - Internal	1.130 mm	1 Adet / 1 Pcs
130-0200-1410-1230	Kapı Altı Giyotini / Door Seal - Internal	1.230 mm	1 Adet / 1 Pcs

Underline 210 • KAPI ALTI GIYOTINI • DOOR SEAL

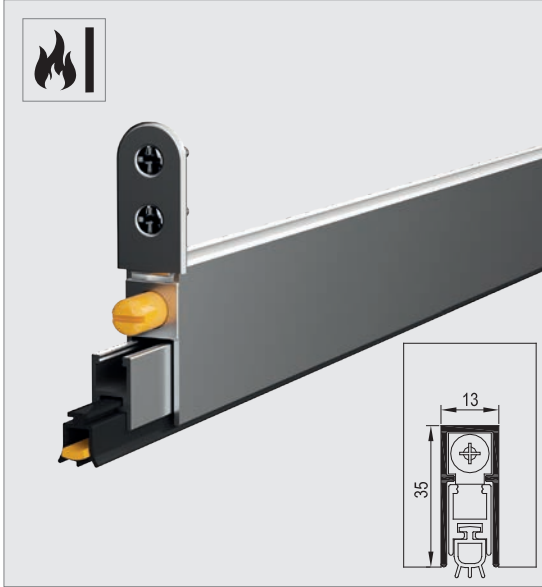

Bilgi / Information

- 0'dan 20 mm alt açıklığa kadar kapatabilme imkanı sunar.
- Mekanizma baskı ayarı yapılabilir.
- 10 cm. kadar kısaltma yapılabilir.
- Özel ölçü için lütfen müşteri temsilciniz ile irtibata geçiniz.
- Özel üretimlerde Minimum 200 adet sipariş kabul edilir.

- Usable for 0 - 20 mm drop
- Pressure can be adjusted
- Shortened up to 10 cm.
- Custom sizes, please contact your customer representative.
- Minimum 200 pcs orders are accepted in for special manufacturers.



Kod / Code No	Açıklama / Description	Boy / Size	Birim / Unit
130-0210-1410-0830	Yangına Dayanımlı Kapı Altı Giyotini / Door Seal (Fire Protection)- Internal	830 mm	1 Adet / 1 Pcs
130-0210-1410-0930	Yangına Dayanımlı Kapı Altı Giyotini / Door Seal (Fire Protection)- Internal	930 mm	1 Adet / 1 Pcs
130-0210-1410-1030	Yangına Dayanımlı Kapı Altı Giyotini / Door Seal (Fire Protection)- Internal	1.030 mm	1 Adet / 1 Pcs
130-0210-1410-1130	Yangına Dayanımlı Kapı Altı Giyotini / Door Seal (Fire Protection)- Internal	1.130 mm	1 Adet / 1 Pcs
130-0210-1410-1230	Yangına Dayanımlı Kapı Altı Giyotini / Door Seal (Fire Protection)- Internal	1.230 mm	1 Adet / 1 Pcs

Underline 220 • KAPI ALTI GIYOTINI • DOOR SEAL

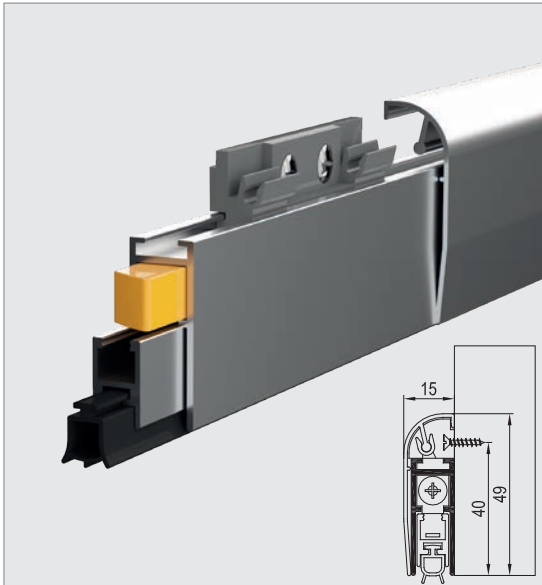

Bilgi / Information

- Tüm ahşap ve alüminyum kapı detaylarında kullanılabilir.
- 0'dan 20 mm alt açıklığa kadar kapatabilme imkanı sunar.
- Mekanizma baskı ayarı yapılabilir.
- 10 cm. kadar kısaltma yapılabilir.
- Özel ölçü için lütfen müşteri temsilciniz ile irtibata geçiniz.
- Özel üretimlerde Minimum 200 adet sipariş kabul edilir.

- Usable for wooden and aluminium doors
- Usable for 0 - 20 mm drop
- Pressure can be adjusted
- Shortened up to 10 cm.
- Custom sizes, please contact your customer representative.
- Minimum 200 pcs orders are accepted in for special manufacturers.



Kod / Code No	Açıklama / Description	Boy / Size	Birim / Unit
130-0220-1410-0530	Kapı Altı Giyotini - Dıştan / Door Seal - External	530 mm	1 Adet / 1 Pcs
130-0220-1410-0830	Kapı Altı Giyotini - Dıştan / Door Seal - External	830 mm	1 Adet / 1 Pcs
130-0220-1410-0930	Kapı Altı Giyotini - Dıştan / Door Seal - External	930 mm	1 Adet / 1 Pcs
130-0220-1410-1030	Kapı Altı Giyotini - Dıştan / Door Seal - External	1.030 mm	1 Adet / 1 Pcs
130-0220-1410-1130	Kapı Altı Giyotini - Dıştan / Door Seal - External	1.130 mm	1 Adet / 1 Pcs
130-0220-1410-1230	Kapı Altı Giyotini - Dıştan / Door Seal - External	1.230 mm	1 Adet / 1 Pcs

Underline

KAPI ALTI GIYOTİNİ SERİSİ • DOOR SEAL SERIES

Underline 230 • KAPI ALTI GIYOTİNİ • DOOR SEAL

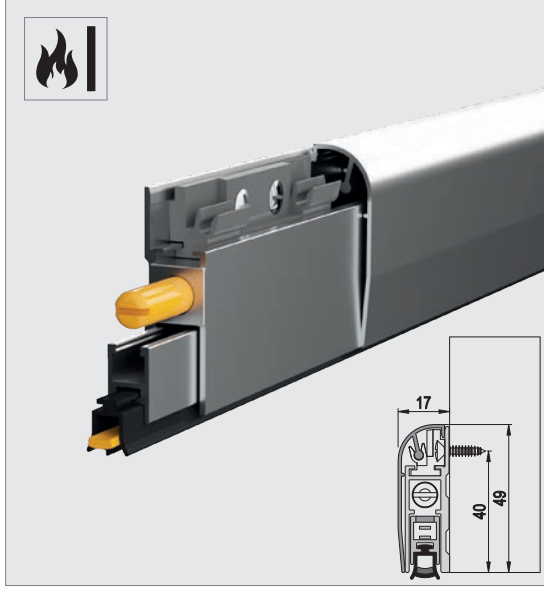

Bilgi / Information

- Tüm ahşap ve alüminyum kapı detaylarında kullanılabilir.
- 0'dan 20 mm alt açıklığa kadar kapatabilme imkanı sunar.
- Mekanizma baskı ayarı yapılabilir.
- 10 cm. kadar kısaltma yapılabilir.
- Özel ölçü için lütfen müşteri temsilciniz ile irtibata geçiniz.
- Özel üretimlerde Minimum 200 adet sipariş kabul edilir.

- Usable for wooden and aluminium doors
- Usable for 0 - 20 mm drop
- Pressure can be adjusted
- Shortened up to 10 cm.
- Custom sizes, please contact your customer representative.
- Minimum 200 pcs orders are accepted in for special manufacturers.



Kod / Code No	Açıklama / Description	Boy / Size	Birim / Unit
130-0230-1410-0830	Yangına Dayanımlı Kapı Altı Giyotini-Dıştan / Door Seal (Fire Protection)	830 mm	1 Adet / 1 Pcs
130-0230-1410-0930	Yangına Dayanımlı Kapı Altı Giyotini-Dıştan / Door Seal (Fire Protection)	930 mm	1 Adet / 1 Pcs
130-0230-1410-1030	Yangına Dayanımlı Kapı Altı Giyotini-Dıştan / Door Seal (Fire Protection)	1.030 mm	1 Adet / 1 Pcs
130-0230-1410-1130	Yangına Dayanımlı Kapı Altı Giyotini-Dıştan / Door Seal (Fire Protection)	1.130 mm	1 Adet / 1 Pcs
130-0230-1410-1230	Yangına Dayanımlı Kapı Altı Giyotini-Dıştan / Door Seal (Fire Protection)	1.230 mm	1 Adet / 1 Pcs

Underline 300 • KAPI ALTI GIYOTİNİ • DOOR SEAL



Bilgi / Information

- Tüm ahşap ve alüminyum kapı detaylarında kullanılabilir.
- 0'dan 13 mm alt açıklığa kadar kapatabilme imkanı sunar.
- Mekanizma baskı ayarı yapılabilir.
- 20 cm. kadar kısaltma yapılabilir.
- Özel ölçü için lütfen müşteri temsilciniz ile irtibata geçiniz.
- Özel üretimlerde minimum 200 adet sipariş kabul edilir.

- Usable for wooden and aluminium doors
- Usable for 0 - 13 mm drop
- Pressure can be adjusted
- Shortened up to 20 cm.
- Custom sizes, please contact your customer representative.
- Minimum 200 pcs orders are accepted in for special manufacturers.



Kod / Code No	Açıklama / Description	Boy / Size	Birim / Unit
130-0300-1410-0460	Underline 300 - Kapı Altı Giyotini / Door Seal - Internal	460 mm	1 Adet / 1 Pcs
130-0300-1410-0630	Underline 300 - Kapı Altı Giyotini / Door Seal - Internal	630 mm	1 Adet / 1 Pcs
130-0300-1410-0830	Underline 300 - Kapı Altı Giyotini / Door Seal - Internal	830 mm	1 Adet / 1 Pcs
130-0300-1410-1030	Underline 300 - Kapı Altı Giyotini / Door Seal - Internal	1.030 mm	1 Adet / 1 Pcs
130-0300-1410-1230	Underline 300 - Kapı Altı Giyotini / Door Seal - Internal	1.230 mm	1 Adet / 1 Pcs



Domino 90

90 DERECE AÇILIR KATLANIR KAPI DONANIMI • 90 DEGREE BI-FOLDING DOOR HARDWARE

Yeni Ürün
New Product

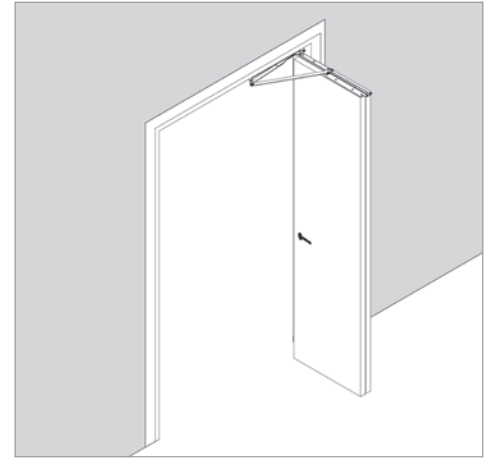
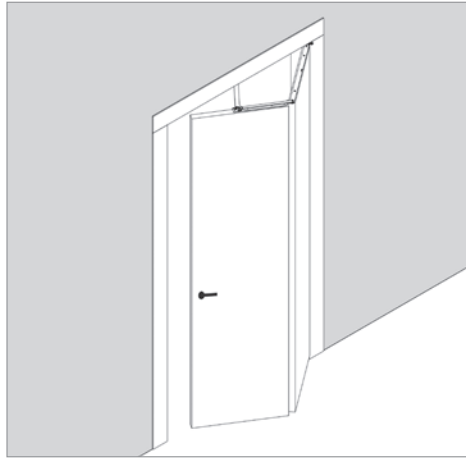
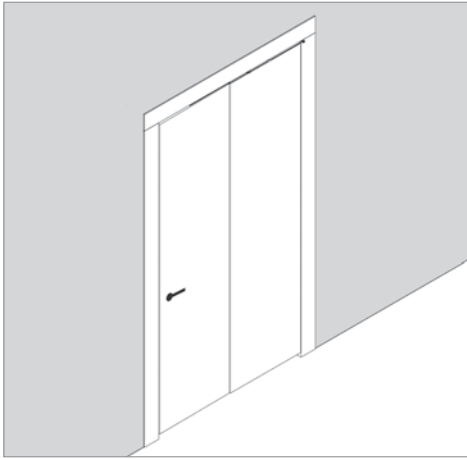
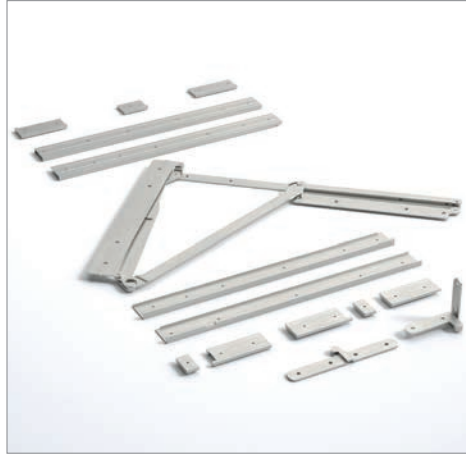

Kod / Code No	Açıklama / Description	Boy / Size	Birim / Unit
131-0090-0900-0600	Domino 90 - Sağ Kapı / Right Door	600 mm	1 Tk. / 1 Set
131-0090-0900-0700	Domino 90 - Sağ Kapı / Right Door	700 mm	1 Tk. / 1 Set
131-0090-0900-0800	Domino 90 - Sağ Kapı / Right Door	800 mm	1 Tk. / 1 Set
131-0090-0900-0900	Domino 90 - Sağ Kapı / Right Door	900 mm	1 Tk. / 1 Set
131-0090-0900-1000	Domino 90 - Sağ Kapı / Right Door	1.000 mm	1 Tk. / 1 Set
131-0095-0900-0600	Domino 90 - Sol Kapı / Left Door	600 mm	1 Tk. / 1 Set
131-0095-0900-0700	Domino 90 - Sol Kapı / Left Door	700 mm	1 Tk. / 1 Set
131-0095-0900-0800	Domino 90 - Sol Kapı / Left Door	800 mm	1 Tk. / 1 Set
131-0095-0900-0900	Domino 90 - Sol Kapı / Left Door	900 mm	1 Tk. / 1 Set
131-0095-0900-1000	Domino 90 - Sol Kapı / Left Door	1.000 mm	1 Tk. / 1 Set

Bilgi / Information

- 90 derece katlanıp park edilebilir kapı makas sistemidir.
- Dar alan bölgelerde kapının açıldığı esnada yerden tasarruf edilmesini sağlar.
- Ahşap kapılar için tasarlanmıştır.
- 36-44 mm ahşap kapılarda kullanıma uygundur.
- Hızlı montaj kiti 40 mm kapılar için kullanılabilir.
- Sistemin toplam taşıma kapasitesi 50 kg dir.
- Kolay ve ahşap kapı üzerinde herhangi bir freze/cnc işlem gerektirmeden montaj edilebilmesi için montaj yatak kiti kullanılarak da uygulanabilir özelliğe sahiptir.
- Montaj yatak kiti istenilen renkte boyanarak kapı ile bir bütünlük sağlanabilir.
- Ahşap üzerine işlem yapmadan montaj edilebilir.
- Mekanizma gövdesi paslanmaz malzemeden imal edilmiştir.
- Islak mekanlarda kullanılabilir.
- Farklı kanat açıklıkları için 5 tip ölçüde imal edilmiştir.
- Kapının park ettiği alanın görüleceği içten bakış yönüne göre sağ ve sol mekanizma olarak 2 tip üretimi mevcuttur.
- Estetik görünüm ve sağlıklı çalışma sistemine sahiptir.
- İç mekan kapılarda kullanıma uygundur.
- Kapı üzerine istenilen açma kolu ve/veya tutamak tek yönlü montaj edilebilmektedir.

- It's door scissor system that can be fold and parked 90 degrees.
- It's saves space when opening the door in narrow areas.
- Designed for wooden doors.
- It's available for use on 36-44 mm wooden doors.
- The quick assembly kit can be used for 40 mm
- Total carrying capacity of the system is 50 kg.
- Can also be apply by using the mounting bed kit for easy fixing on the wooden door without any milling cutter /cnc operation.
- The assembly bed kit can be paint in the required color and an integrity with the door can be achieved.
- Can be mounted on wood without processing.
- Mechanism body is made of stainless material.
- Can be used in wet places.
- For the gaps of wing , it's produced in 5 different types of sizes
- There are 2 types of production; as right and left mechanism according to the inside view direction from which the area where the door is parked will be seen.
- It has aesthetic appearance and in well working system
- Available for use on interior doors.
- The required door handle and/or handle can be fixing on the door in one direction.

Domino 180

180 DERECE AÇILIR KATLANIR KAPI DONANIMI • 180 DEGREE BI-FOLDING DOOR HARDWARE

Yeni Ürün
New Product

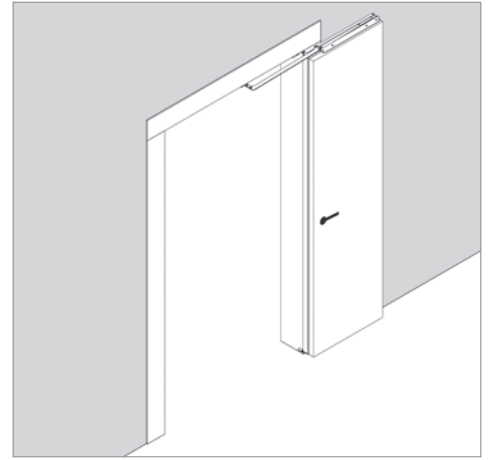
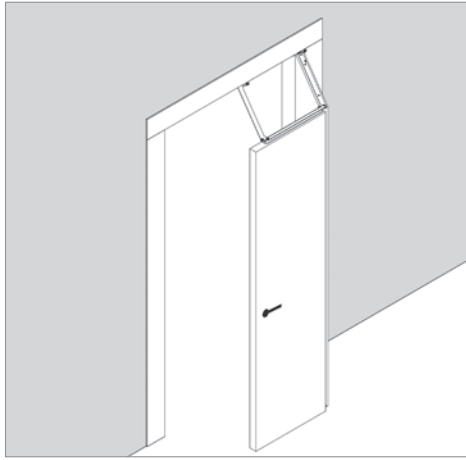
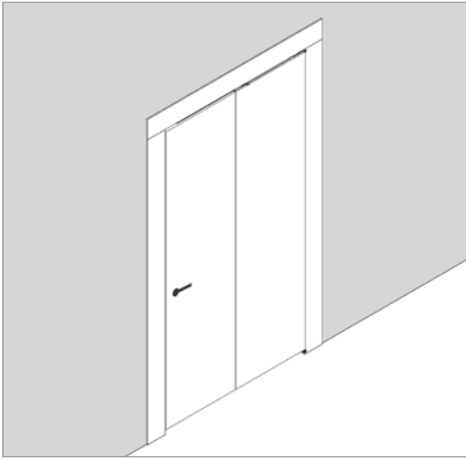

Kod / Code No	Açıklama / Description	Boy / Size	Birim / Unit
131-0180-0900-0600	Domino 180 - Sağ Kapı / Right Door	600 mm	1 Tk. / 1 Set
131-0180-0900-0700	Domino 180 - Sağ Kapı / Right Door	700 mm	1 Tk. / 1 Set
131-0180-0900-0800	Domino 180 - Sağ Kapı / Right Door	800 mm	1 Tk. / 1 Set
131-0180-0900-0900	Domino 180 - Sağ Kapı / Right Door	900 mm	1 Tk. / 1 Set
131-0180-0900-1000	Domino 180 - Sağ Kapı / Right Door	1.000 mm	1 Tk. / 1 Set
131-0185-0900-0600	Domino 180 - Sol Kapı / Left Door	600 mm	1 Tk. / 1 Set
131-0185-0900-0700	Domino 180 - Sol Kapı / Left Door	700 mm	1 Tk. / 1 Set
131-0185-0900-0800	Domino 180 - Sol Kapı / Left Door	800 mm	1 Tk. / 1 Set
131-0185-0900-0900	Domino 180 - Sol Kapı / Left Door	900 mm	1 Tk. / 1 Set
131-0185-0900-1000	Domino 180 - Sol Kapı / Left Door	1.000 mm	1 Tk. / 1 Set

Bilgi / Information

- 180 derece katlanıp park edebilen kapı makas sistemidir.
- Dar alan bölgelerde kapının açıldığı esnada yerden tasarruf edilmesini sağlar.
- Kapı park yönünde, kapı net açıklığının yarısı kadar bir mesafede açılarak net geçiş açıklığının tamamını kullanmanızı sağlar.
- Ahşap kapılar için tasarlanmıştır.
- 36-44 mm ahşap kapılarda kullanıma uygundur.
- Hızlı montaj kiti 40 mm kapılar için kullanılabilir.
- Sistemin toplam taşıma kapasitesi 50 kg dir.
- Gerekli durumlarda gizli menteşe kullanımı ile 3 kanat tek yönde kullanıma uygundur.
- Kolay ve ahşap kapı üzerinde herhangi bir freze/cnc işlem gerektirmeden montaj edilebilmesi için montaj yatak kiti kullanılarak da uygulanabilir özelliğe sahiptir.
- Montaj yatak kiti istenilen renkte boyanarak kapı ile bir bütünlük sağlanabilir.
- Ahşap üzerine işlem yapmadan montaj edilebilir.
- Mekanizma gövdesi paslanmaz malzemeden imal edilmiştir.
- Islak mekanlarda kullanılabilir.
- Farklı kanat açıklıkları için 5 tip ölçüde imal edilmiştir.
- Kapının park ettiği alanın görüleceği içten bakış yönüne göre sağ ve sol mekanizma olarak 2 tip üretimi mevcuttur.
- Estetik görünüm ve sağlıklı çalışma sistemine sahiptir.
- İç mekan kapılarda kullanıma uygundur.
- Kapı üzerine istenilen açma kolu ve/veya tutamak tek yönlü montaj edilebilmektedir.

- It's Door Scissor System that can be fold and parked 180 degrees.
- It's saves space when opening the door in narrow areas.
- The doors in parking direction, at a distance of half the door clear opening, allowing to use the entire clear passage opening.
- Designed for wooden doors.
- It's available for use on 36-44 mm wooden doors.
- The quick assembly kit can be used for 40 mm doors.
- Total carrying capacity of the system is 50 kg.
- 3 doors are suitable for use in one direction with the use of hidden hinges when its necessary.
- Can also be apply by using the mounting bed kit for easy fixing on the wooden door without any milling cutter /cnc operation.
- The assembly bed kit can be paint in the required color and an integrity with the door can be achieved.
- Can be mounted on wood without processing.
- Mechanism body is made of stainless material.
- Can be used in wet places.
- For the gaps of wing, it's produced in 5 different types of sizes.
- There are 2 types of production; as right and left mechanism according to the inside view direction from which the area where the door is parked will be seen.
- It has aesthetic appearance and in well working system
- Available for use on interior doors.
- The required door handle and/or handle can be fixing on the door in one direction.

Kilit Cebi

LOCK POCKET

131-0100 • KİLİT CEBİ • LOCK POCKET

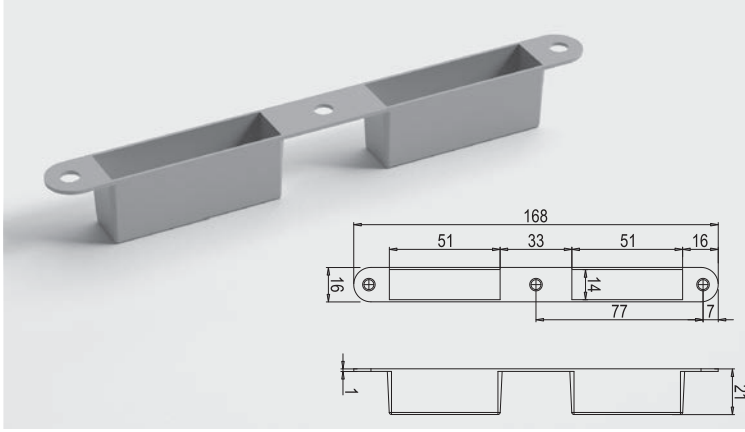

Bilgi / Information

- Ahşap kapılarda kilit karşılığının altındaki detayı kapatmak amacı ile kullanılır.
- Kullanımda olan kilit DIN normlarına uygundur.
- It is used to close the details bottom of the door lock striker on the doors of wood
- Suitable for lock DIN standarts which use in the markets

Kod / Code No	Renk / Colour	Br. / Unit		
131-0100-1660	Krem / Cream	1 Adet / 1 Pcs	100	6.000
131-0100-1650	Beyaz / White	1 Adet / 1 Pcs	100	6.000
131-0100-1670	Kahve / Brown	1 Adet / 1 Pcs	100	6.000
131-0100-1600	Gri / Grey	1 Adet / 1 Pcs	100	6.000



131-0110 • KİLİT CEBİ • LOCK POCKET

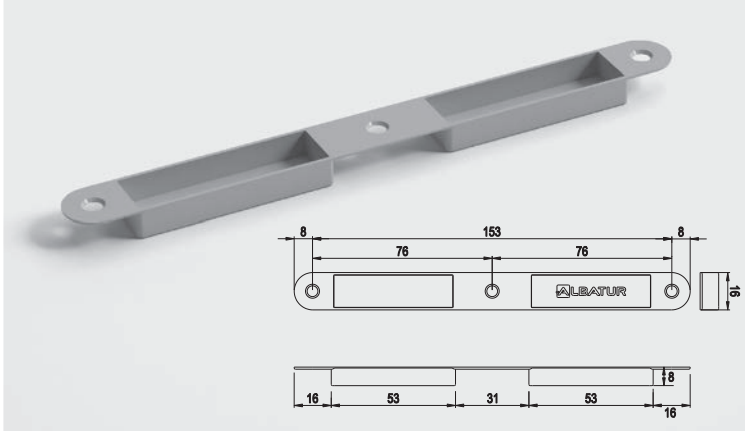

Bilgi / Information

- Ahşap kapılarda kilit karşılığının altındaki detayı kapatmak amacı ile kullanılır.
- Kullanımda olan kilit DIN normlarına uygundur.
- It is used to close the details bottom of the door lock striker on the doors of wood
- Suitable for lock DIN standarts which use in the markets

Kod / Code No	Renk / Colour	Br. / Unit		
131-0110-1660	Krem / Cream	1 Adet / 1 Pcs	100	6.000
131-0110-1650	Beyaz / White	1 Adet / 1 Pcs	100	6.000
131-0110-1670	Kahve / Brown	1 Adet / 1 Pcs	100	6.000



131-0120 • KİLİT CEBİ • LOCK POCKET

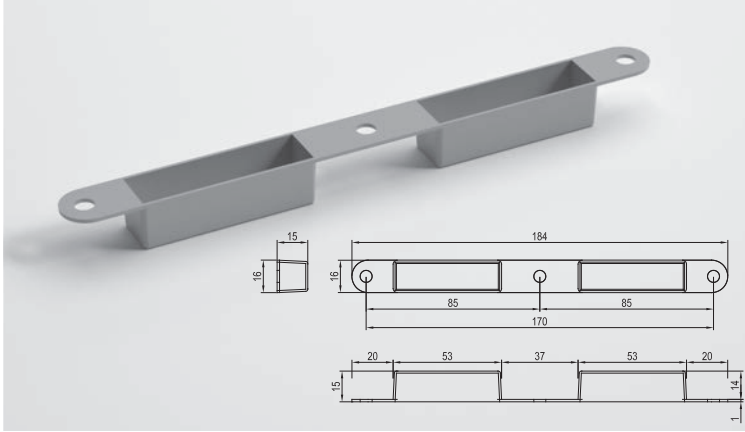

Bilgi / Information

- Ahşap kapılarda kilit karşılığının altındaki detayı kapatmak amacı ile kullanılır.
- Kullanımda olan kilit DIN normlarına uygundur.
- It is used to close the details bottom of the door lock striker on the doors of wood
- Suitable for lock DIN standarts which use in the markets

Kod / Code No	Renk / Colour	Br. / Unit		
131-0120-1600	Gri / Grey	1 Adet / 1 Pcs	100	6.000



131-0130 • KİLİT CEBİ • LOCK POCKET

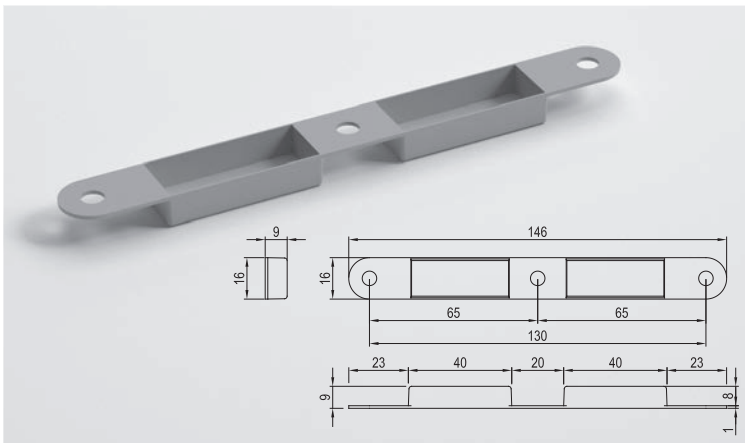

Bilgi / Information

- Ahşap kapılarda kilit karşılığının altındaki detayı kapatmak amacı ile kullanılır.
- Kullanımda olan kilit DIN normlarına uygundur.
- It is used to close the details bottom of the door lock striker on the doors of wood
- Suitable for lock DIN standarts which use in the markets

Kod / Code No	Renk / Colour	Br. / Unit		
131-0130-1600	Gri / Grey	1 Adet / 1 Pcs	100	6.000



Menteşe

ÇELİK MENTEŞE • STEEL HINGE



■ Teknik Detay / Technical Detail

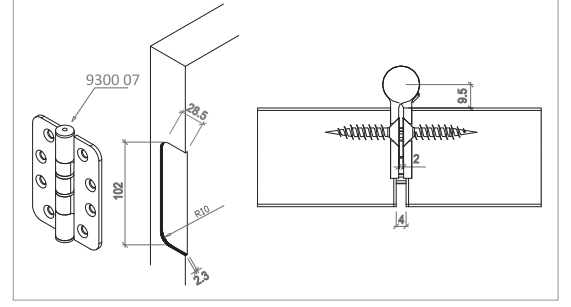

■ Bilgi / Information

- Taşıma kapasitesi, 1 kanat için 3 menteşe kullanılarak 80 kg kadardır.
- Carrying capacity : For 1 door 3 hinges using maximum to 80 kg

Kod / Code No	Açıklama / Description	Renk / Colour	Birim / Unit		
122-9300-1410-507	Çelik Menteşe / Steel Hinge	Galvaniz / Galvanized	1 Adet / 1 Pcs	50	4800

Menteşe

ÇELİK MENTEŞE • STEEL HINGE

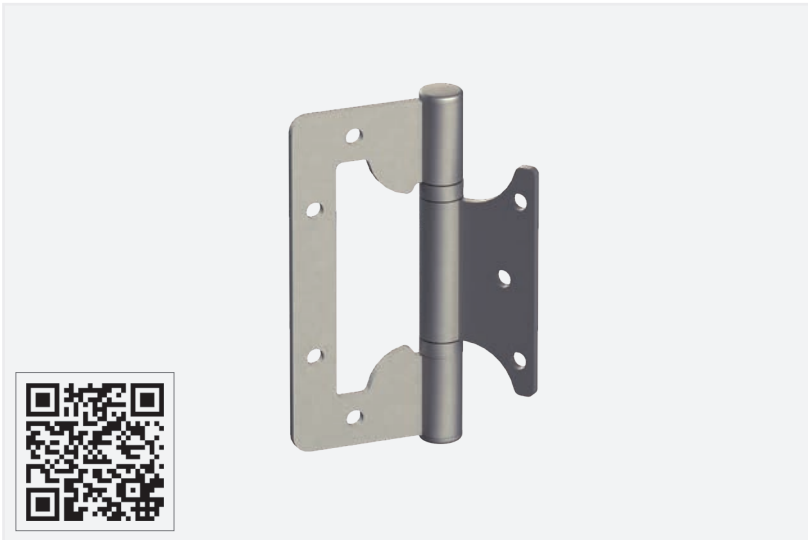

■ Teknik Detay / Technical Detail

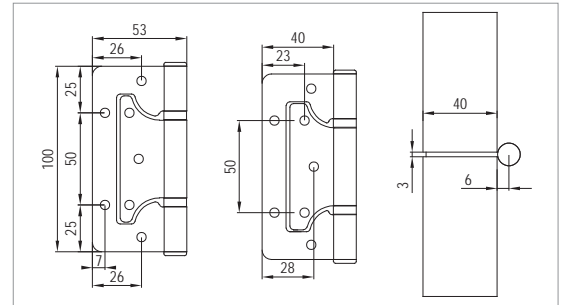

■ Bilgi / Information

- Taşıma kapasitesi, 1 kanat için 3 menteşe kullanılarak 40 kg kadardır.
- Carrying capacity : For 1 door 3 hinges using maximum to 40 kg

Kod / Code No	Açıklama / Description	Renk / Colour	Birim / Unit		
122-9061-1300-505	Çelik Menteşe / Steel Hinge	Galvaniz / Galvanized	1 Adet / 1 Pcs	50	4800

131-0200

OTOMATİK KAPI SÜRGÜSÜ (YÖNSÜZ) • AUTOMATIC DOOR BOLT (NONDIRECTIVE)

Yeni Ürün
New Product



Teknik Detay / Technical Detail

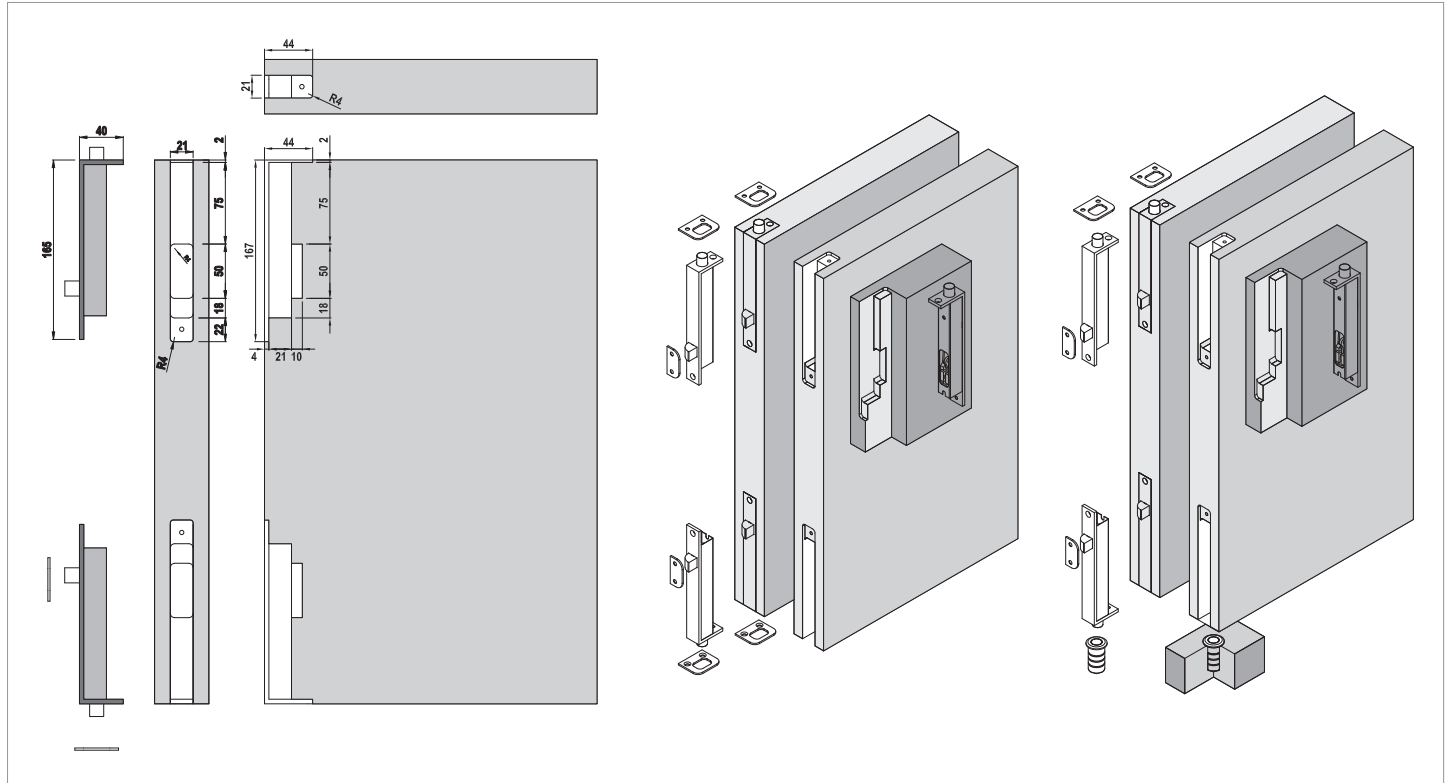

Kod / Code No	Açıklama / Description	Renk / Colour	Birim / Unit		
131-0200-1810	Otomatik Kapı Sürgüsü (Yönsüz) / Automatic Door Bolt (Nondirective)	Altın / Gold	1 Adet / 1 Pcs	24	480
131-0200-1820	Otomatik Kapı Sürgüsü (Yönsüz) / Automatic Door Bolt (Nondirective)	Saten / Satin	1 Adet / 1 Pcs	24	480

131-0210

YER SOKETİ • DUST PROOF STRIKE

Yeni Ürün
New Product

1 Set İçeriği / 1 Set Includes



131-0210-1820

1 Set İçeriği / 1 Set Includes



131-0210-1810



Teknik Detay / Technical Detail

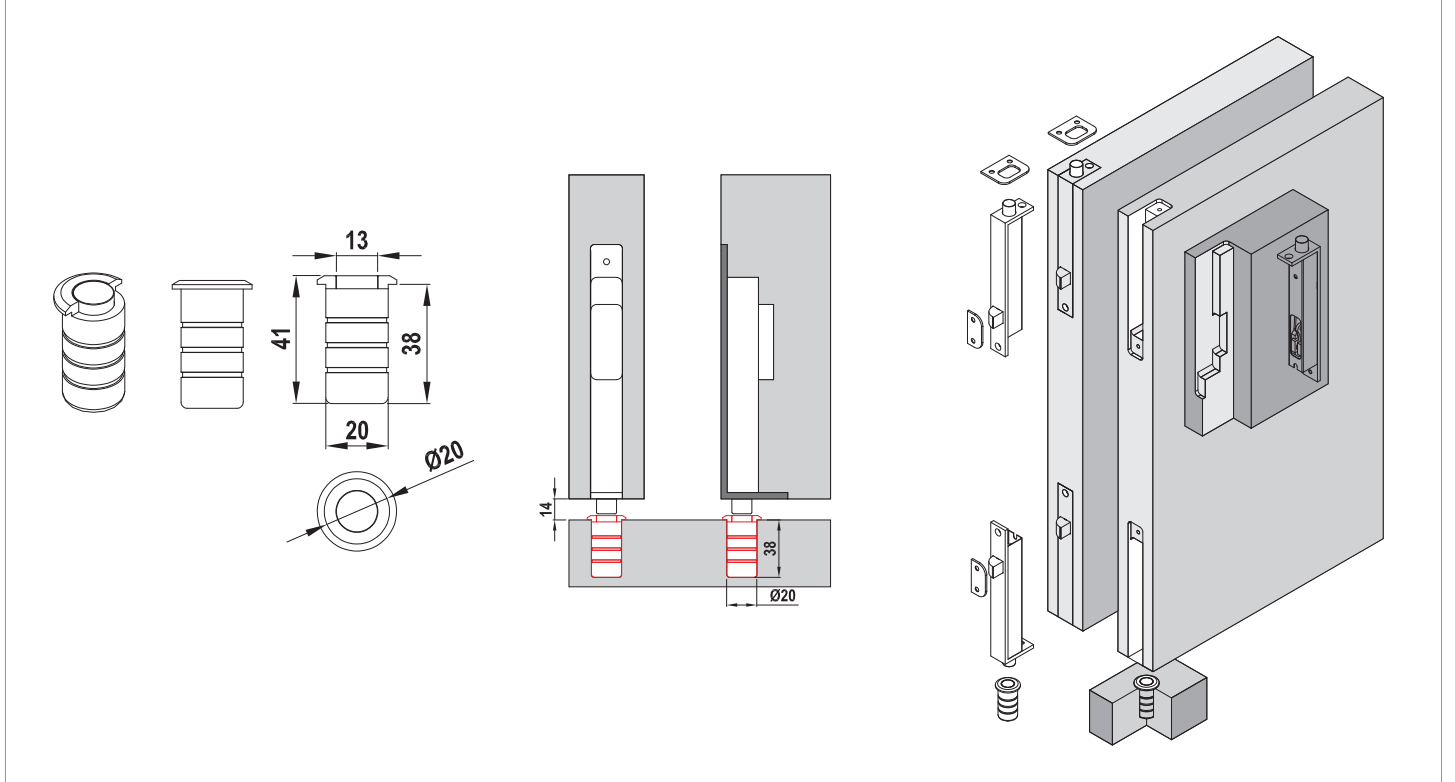

Kod / Code No	Açıklama / Description	Renk / Colour	Birim / Unit		
131-0210-1810	Yer Soketi • Dust Proof Strike	Altın / Gold	1 Adet / 1 Pcs	24	480
131-0210-1820	Yer Soketi • Dust Proof Strike	Saten / Satin	1 Adet / 1 Pcs	24	480

MagicLift 1100

GARDIROP ASANSÖRÜ • LIFT FOR WARDROBE



OIL
DAMPER

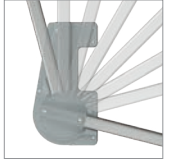

Kod / Code No	Açıklama / Description	Renk / Colour	Birim / Unit		
135-1100-3610	MagicLift 15 Kg - Gardirop asansörü / Lift For Wardrobe	Gri / Grey	1 Adet / 1 Pcs	6	72
135-1100-3620	MagicLift 15 Kg - Gardirop asansörü / Lift For Wardrobe	Antrasit / Anthracite	1 Adet / 1 Pcs	6	72
135-1110-3610	MagicLift 10 Kg - Gardirop asansörü / Lift For Wardrobe	Gri / Grey	1 Adet / 1 Pcs	6	72
135-1110-3620	MagicLift 10 Kg - Gardirop asansörü / Lift For Wardrobe	Antrasit / Anthracite	1 Adet / 1 Pcs	6	72

MagicLift 1101

GARDIROP ASANSÖRÜ MONTAJ APARATI • LIFT FOR WARDROBE Mounting APPARATUS



Kod / Code No	Açıklama / Description	Renk / Colour	Birim / Unit		
135-1101-1610	Gardirop Asansörü Montaj Aparatı • Lift For Wardrobe Mounting Apparatus	Gri / Grey	1 Adet / 1 Pcs	6	192
135-1101-1620	Gardirop Asansörü Montaj Aparatı • Lift For Wardrobe Mounting Apparatus	Antrasit / Anthracite	1 Adet / 1 Pcs	6	192

Ventil Aluminium

ALÜMİNYUM DEKORATİF MENFEZ • ALUMINIUM AIR VENTILATION COVER

Ventil 440 • BAR MENFEZ • AIR VENTILATION COVER



Bilgi / Information

- Eni 60 mm
- Width 60 mm

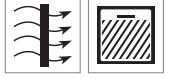

Kod / Code No	Boy / Size	Renk / Colour	Birim / Unit		
140-0440-1410-0423	423 mm	Eloksal / Mat Anodized	1 Adet / 1 Pcs	10	630
140-0440-1410-0610	610 mm	Eloksal / Mat Anodized	1 Adet / 1 Pcs	10	420
140-0440-1410-0900	900 mm	Eloksal / Mat Anodized	1 Adet / 1 Pcs	10	420
140-0440-1420-0423	423 mm	Parlak / Bright	1 Adet / 1 Pcs	10	630
140-0440-1420-0610	610 mm	Parlak / Bright	1 Adet / 1 Pcs	10	420
140-0440-1420-0900	900 mm	Parlak / Bright	1 Adet / 1 Pcs	10	420

Ventil 460 • BAR MENFEZ • AIR VENTILATION COVER

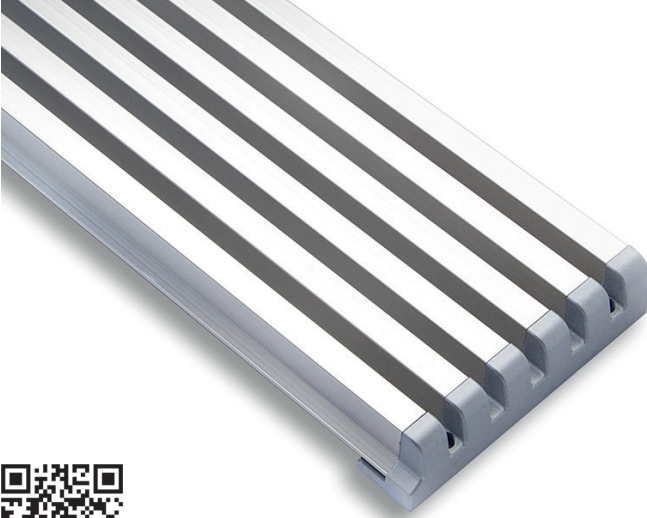

Bilgi / Information

- Eni 90 mm
- Width 90 mm

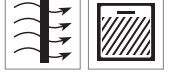

Kod / Code No	Boy / Size	Renk / Colour	Birim / Unit		
140-0460-1410-0423	423 mm	Eloksal / Mat Anodized	1 Adet / 1 Pcs	10	630
140-0460-1410-0610	610 mm	Eloksal / Mat Anodized	1 Adet / 1 Pcs	10	420
140-0460-1410-0900	900 mm	Eloksal / Mat Anodized	1 Adet / 1 Pcs	10	420
140-0460-1420-0423	423 mm	Parlak / Bright	1 Adet / 1 Pcs	10	630
140-0460-1420-0610	610 mm	Parlak / Bright	1 Adet / 1 Pcs	10	420
140-0460-1420-0900	900 mm	Parlak / Bright	1 Adet / 1 Pcs	10	420

Ventil 480 • BAR MENFEZ • AIR VENTILATION COVER

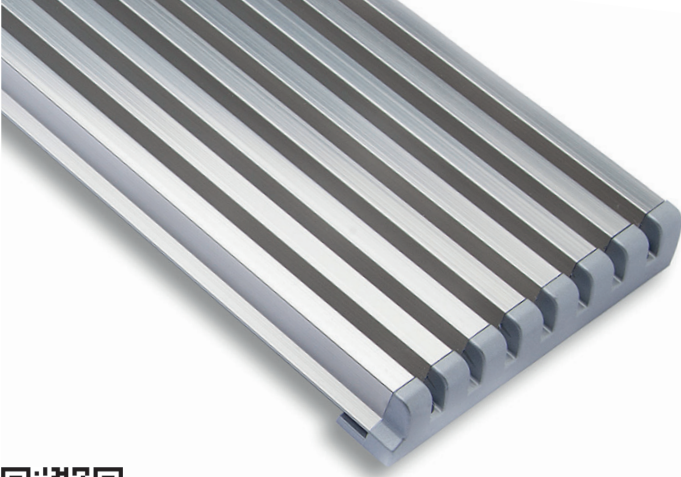

Bilgi / Information

- Eni 120 mm
- Width 120 mm

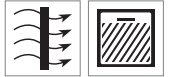

Kod / Code No	Boy / Size	Renk / Colour	Birim / Unit		
140-0480-1410-0423	423 mm	Eloksal / Mat Anodized	1 Adet / 1 Pcs	10	630
140-0480-1410-0610	610 mm	Eloksal / Mat Anodized	1 Adet / 1 Pcs	10	420
140-0480-1410-0900	900 mm	Eloksal / Mat Anodized	1 Adet / 1 Pcs	10	420
140-0480-1420-0423	423 mm	Parlak / Bright	1 Adet / 1 Pcs	10	630
140-0480-1420-0610	610 mm	Parlak / Bright	1 Adet / 1 Pcs	10	420
140-0480-1420-0900	900 mm	Parlak / Bright	1 Adet / 1 Pcs	10	420

Ventil Aluminium

ALÜMİNYUM DEKORATİF MENFEZ • ALUMINIUM AIR VENTILATION COVER

Ventil 900 • KOZA MENFEZ • AIR VENTILATION COVER

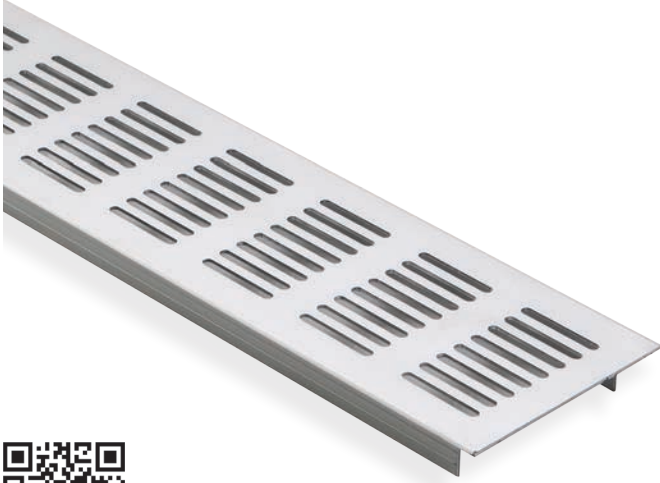

Bilgi / Information

- Eni 70 mm
- Birim adet fiyatlandır.
- Pakette 2 adet mevcuttur.

- Width 70 mm
- Unit prices.
- 2 Pcs in a bag.



Kod / Code No	Boy / Size	Renk / Colour	Birim / Unit		
140-0900-1410-0200	200 mm	Eloksal / Mat Anodized	1 Adet / 1 Pcs	20	3.000
140-0900-1410-0270	270 mm	Eloksal / Mat Anodized	1 Adet / 1 Pcs	20	2.000
140-0900-1410-0423	423 mm	Eloksal / Mat Anodized	1 Adet / 1 Pcs	20	1.200
140-0900-1410-0500	500 mm	Eloksal / Mat Anodized	1 Adet / 1 Pcs	20	1.200
140-0900-1410-0610	610 mm	Eloksal / Mat Anodized	1 Adet / 1 Pcs	20	800
140-0900-1410-0763	763 mm	Eloksal / Mat Anodized	1 Adet / 1 Pcs	20	500
140-0900-1420-0270	270 mm	Parlak / Bright	1 Adet / 1 Pcs	20	2.000
140-0900-1420-0423	423 mm	Parlak / Bright	1 Adet / 1 Pcs	20	1.200
140-0900-1420-0500	500 mm	Parlak / Bright	1 Adet / 1 Pcs	20	1.200
140-0900-1420-0610	610 mm	Parlak / Bright	1 Adet / 1 Pcs	20	800

Ventil 700 • KOZA MENFEZ • AIR VENTILATION COVER

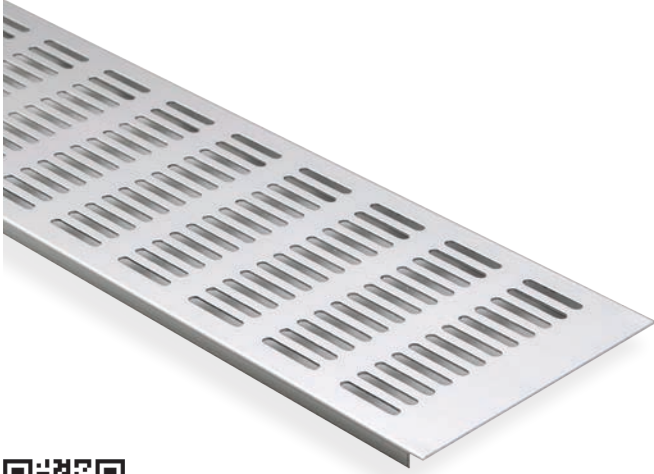

Bilgi / Information

- Eni 120 mm
- Birim adet fiyatlandır.
- Pakette 2 adet mevcuttur.

- Width 120 mm
- Unit prices.
- 2 Pcs in a bag.

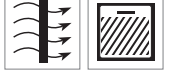

Kod / Code No	Boy / Size	Renk / Colour	Birim / Unit		
140-0700-1410-0200	200 mm	Eloksal / Mat Anodized	1 Adet / 1 Pcs	20	2.500
140-0700-1410-0270	270 mm	Eloksal / Mat Anodized	1 Adet / 1 Pcs	20	2.000
140-0700-1410-0423	423 mm	Eloksal / Mat Anodized	1 Adet / 1 Pcs	20	800
140-0700-1410-0500	500 mm	Eloksal / Mat Anodized	1 Adet / 1 Pcs	20	800
140-0700-1410-0610	610 mm	Eloksal / Mat Anodized	1 Adet / 1 Pcs	20	800
140-0700-1410-0763	763 mm	Eloksal / Mat Anodized	1 Adet / 1 Pcs	20	600
140-0700-1420-0270	270 mm	Parlak / Bright	1 Adet / 1 Pcs	20	2.000
140-0700-1420-0423	423 mm	Parlak / Bright	1 Adet / 1 Pcs	20	800
140-0700-1420-0500	500 mm	Parlak / Bright	1 Adet / 1 Pcs	20	800
140-0700-1420-0610	610 mm	Parlak / Bright	1 Adet / 1 Pcs	20	800

Ventil 750 • KOZA MENFEZ • AIR VENTILATION COVER



Bilgi / Information

- Eni 200 mm
- Birim adet fiyatlandır.
- Pakette 2 adet mevcuttur.

- Width 200 mm
- Unit prices.
- 2 Pcs in a bag.



Kod / Code No	Boy / Size	Renk / Colour	Birim / Unit		
140-0750-1410-0270	270 mm	Eloksal / Mat Anodized	1 Adet / 1 Pcs	10	800
140-0750-1410-0423	423 mm	Eloksal / Mat Anodized	1 Adet / 1 Pcs	10	600
140-0750-1410-0500	500 mm	Eloksal / Mat Anodized	1 Adet / 1 Pcs	10	600
140-0750-1410-0610	610 mm	Eloksal / Mat Anodized	1 Adet / 1 Pcs	10	400
140-0750-1410-0763	763 mm	Eloksal / Mat Anodized	1 Adet / 1 Pcs	10	250
140-0750-1410-1000	1000 mm	Eloksal / Mat Anodized	1 Adet / 1 Pcs	4	120
140-0750-1410-2000	2000 mm	Eloksal / Mat Anodized	1 Adet / 1 Pcs	4	120

Ventil Aluminium

ALÜMİNYUM DEKORATİF MENFEZ • ALUMINIUM AIR VENTILATION COVER

Ventil 950 • KARE MENFEZ • AIR VENTILATION COVER





Bilgi / Information

- Eni 70 mm
- Birim adet fiyatlandır.
- Pakette 2 adet mevcuttur.

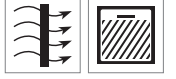
- Width 70 mm
- Unit prices.
- 2 Pcs in a bag.



Kod / Code No	Boy / Size	Renk / Colour	Birim / Unit		
140-0950-1410-0200	200 mm	Eloksal / Mat Anodized	1 Adet / 1 Pcs	20	3.000
140-0950-1410-0270	270 mm	Eloksal / Mat Anodized	1 Adet / 1 Pcs	20	2.000
140-0950-1410-0423	423 mm	Eloksal / Mat Anodized	1 Adet / 1 Pcs	20	1.200
140-0950-1410-0500	500 mm	Eloksal / Mat Anodized	1 Adet / 1 Pcs	20	1.200
140-0950-1410-0610	610 mm	Eloksal / Mat Anodized	1 Adet / 1 Pcs	20	800
140-0950-1410-0763	763 mm	Eloksal / Mat Anodized	1 Adet / 1 Pcs	20	500

Ventil 800 • KARE MENFEZ • AIR VENTILATION COVER

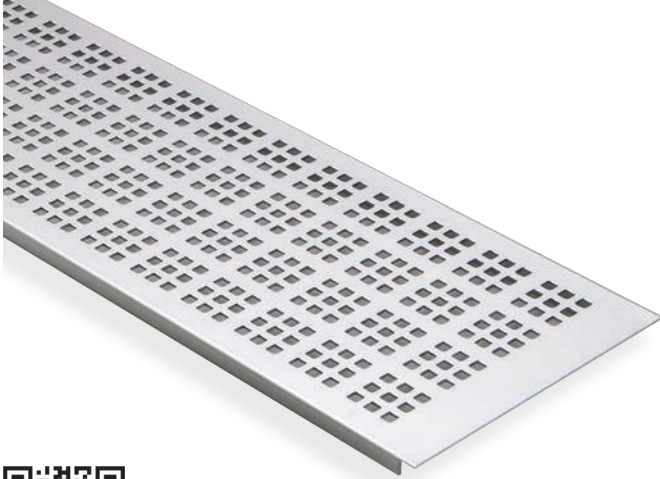

Bilgi / Information

- Eni 120 mm
- Birim adet fiyatlandır.
- Pakette 2 adet mevcuttur.

- Width 120 mm
- Unit prices.
- 2 Pcs in a bag.



Kod / Code No	Boy / Size	Renk / Colour	Birim / Unit		
140-0800-1410-0200	200 mm	Eloksal / Mat Anodized	1 Adet / 1 Pcs	20	2.500
140-0800-1410-0270	270 mm	Eloksal / Mat Anodized	1 Adet / 1 Pcs	20	2.000
140-0800-1410-0423	423 mm	Eloksal / Mat Anodized	1 Adet / 1 Pcs	20	800
140-0800-1410-0500	500 mm	Eloksal / Mat Anodized	1 Adet / 1 Pcs	20	800
140-0800-1410-0610	610 mm	Eloksal / Mat Anodized	1 Adet / 1 Pcs	20	800
140-0800-1410-0763	763 mm	Eloksal / Mat Anodized	1 Adet / 1 Pcs	20	600

Ventil 850 • KARE MENFEZ • AIR VENTILATION COVER

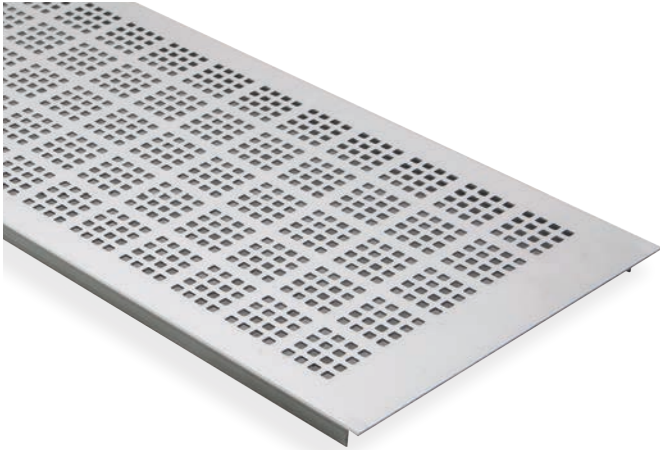



Bilgi / Information

- Eni 200 mm
- Birim adet fiyatlandır.
- Pakette 2 adet mevcuttur.

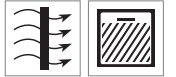
- Width 200 mm
- Unit prices.
- 2 Pcs in a bag.



Kod / Code No	Boy / Size	Renk / Colour	Birim / Unit		
140-0850-1410-0270	270 mm	Eloksal / Mat Anodized	1 Adet / 1 Pcs	10	800
140-0850-1410-0423	423 mm	Eloksal / Mat Anodized	1 Adet / 1 Pcs	10	600
140-0850-1410-0500	500 mm	Eloksal / Mat Anodized	1 Adet / 1 Pcs	10	600
140-0850-1410-0610	610 mm	Eloksal / Mat Anodized	1 Adet / 1 Pcs	10	400
140-0850-1410-0763	763 mm	Eloksal / Mat Anodized	1 Adet / 1 Pcs	10	250

Ventil Plastic

PLASTİK DEKORATİF MENFEZ • PLASTIC AIR VENTILATION COVER

■ Ventil 0680 • PLASTİK MENFEZ • PLASTIC AIR VENTILATION COVER 76x430 mm



■ Bilgi / Information

- Birim adet fiyatlandırır.
- Pakette 2 adet mevcuttur.
- Unit prices.
- 2 Pcs in a bag.

Kod / Code No	Renk / Colour	Br. / Unit		
141-0680-1700	M.Gri / M.Grey	1 Adet / 1 Pcs	10	280
141-0680-1650	Beyaz / White	1 Adet / 1 Pcs	10	280
141-0680-1670	K.Kahve / D.Brown	1 Adet / 1 Pcs	10	280
141-0680-1600	Gri / Grey	1 Adet / 1 Pcs	10	280
141-0680-1680	Akçaağaç / Oak	1 Adet / 1 Pcs	10	280

■ Ventil 0650 • PLASTİK MENFEZ • PLASTIC AIR VENTILATION COVER 70x466 mm

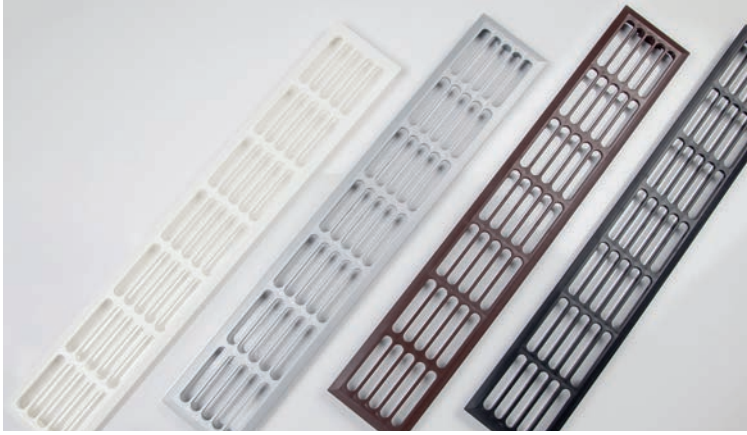

■ Bilgi / Information

- Birim adet fiyatlandırır.
- Pakette 2 adet mevcuttur.
- Unit prices.
- 2 Pcs in a bag.

Kod / Code No	Renk / Colour	Br. / Unit		
141-0650-1700	M.Gri / M.Grey	1 Adet / 1 Pcs	14	400
141-0650-1650	Beyaz / White	1 Adet / 1 Pcs	14	400
141-0650-1670	K.Kahve / D.Brown	1 Adet / 1 Pcs	14	400
141-0650-1630	Siyah / Black	1 Adet / 1 Pcs	14	400

■ Ventil 0630 • PLASTİK MENFEZ • PLASTIC AIR VENTILATION COVER 51x215 mm

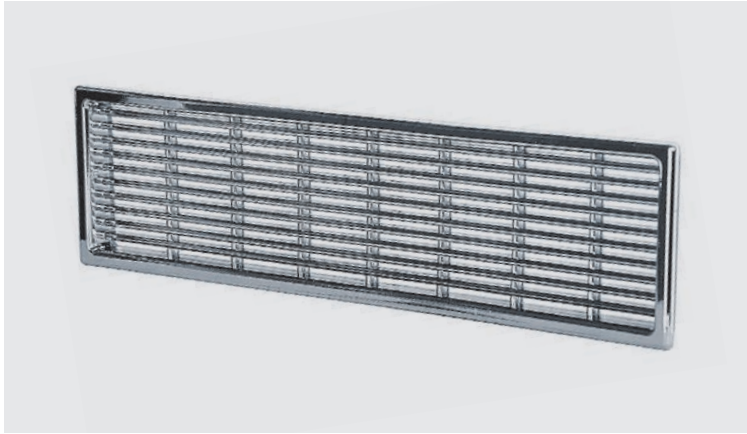

■ Bilgi / Information

- Birim adet fiyatlandırır.
- Unit Prices

Kod / Code No	Renk / Colour	Br. / Unit		
141-0630-1800	Krom / Chrome	1 Adet / 1 Pcs	50	2.000
141-0630-1810	Mat Krom / Mat Chrome	1 Adet / 1 Pcs	50	2.000

■ Ventil 0640 • PLASTİK MENFEZ • PLASTIC AIR VENTILATION COVER 35x164 mm

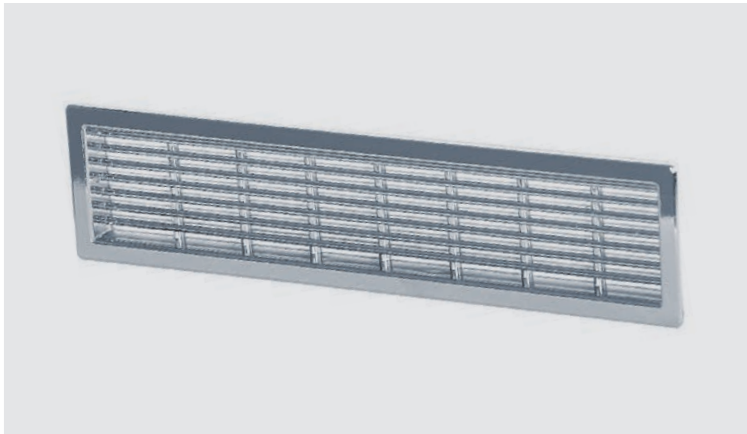

■ Bilgi / Information

- Birim adet fiyatlandırır.
- Unit Prices

Kod / Code No	Renk / Colour	Br. / Unit		
141-0640-1800	Krom / Chrome	1 Adet / 1 Pcs	50	2.000
141-0640-1810	Mat Krom / Mat Chrome	1 Adet / 1 Pcs	50	2.000

Ventil Plastic

PLASTİK DEKORATİF MENFEZ • PLASTIC AIR VENTILATION COVER

■ Ventil 0670 • PLASTİK MENFEZ • PLASTIC AIR VENTILATION COVER 50x50 mm



■ Bilgi / Information

- Birim adet fiyatlandırır.
- Unit Prices

Kod / Code No	Renk / Colour	Br. / Unit		
141-0670-1800	Krom / Chrome	1 Adet / 1 Pcs	50	2.500
141-0670-1810	Mat Krom / Mat Chrome	1 Adet / 1 Pcs	50	2.500

■ Ventil 0600 • PLASTİK MENFEZ • PLASTIC AIR VENTILATION COVER 200x30 mm

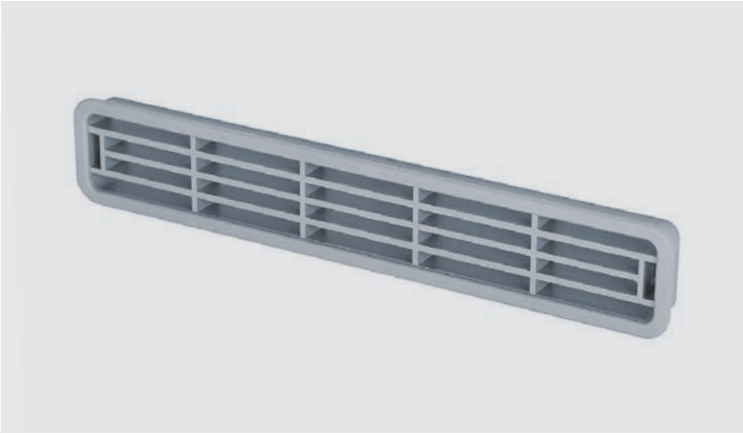

■ Bilgi / Information

- Birim adet fiyatlandırır.
- Unit Prices

Kod / Code No	Renk / Colour	Br. / Unit		
141-0600-1600	M.Gri / M.Grey	1 Adet / 1 Pcs	100	6.000
141-0600-1660	Krem / Cream	1 Adet / 1 Pcs	100	6.000
141-0600-1671	Kahve / Brown	1 Adet / 1 Pcs	100	6.000
141-0600-1670	K.Kahve / D.Brown	1 Adet / 1 Pcs	100	6.000
141-0600-1800	Krom / Chrome	1 Adet / 1 Pcs	50	6.000
141-0600-1630	Siyah / Black	1 Adet / 1 Pcs	100	6.000

■ Ventil 0660 • PLASTİK MENFEZ • PLASTIC AIR VENTILATION COVER Ø44 mm



■ Bilgi / Information

- Birim adet fiyatlandırır.
- Unit Prices

Kod / Code No	Renk / Colour	Br. / Unit		
141-0660-1650	Beyaz / White	1 Adet / 1 Pcs	100	5.000
141-0660-1670	K.Kahve / D.Brown	1 Adet / 1 Pcs	100	5.000
141-0660-1600	Gri / Grey	1 Adet / 1 Pcs	100	5.000
141-0660-1800	Krom / Chrome	1 Adet / 1 Pcs	100	5.000

■ Ventil 0610 • PLASTİK MENFEZ • PLASTIC AIR VENTILATION COVER Ø60 mm



■ Bilgi / Information

- Birim adet fiyatlandırır.
- Unit Prices

Kod / Code No	Renk / Colour	Br. / Unit		
141-0610-1650	Beyaz / White	1 Adet / 1 Pcs	100	4.000
141-0610-1670	K.Kahve / D.Brown	1 Adet / 1 Pcs	100	4.000
141-0610-1600	Gri / Grey	1 Adet / 1 Pcs	100	4.000
141-0610-1800	Krom / Chrome	1 Adet / 1 Pcs	100	4.000

TurnTable

DÖNER TABLA MEKANİZMASI • SWIVEL PLATE - TURNABLE TABLE MECHANISM

TurnTable 60 • DÖNER TABLA MEKANİZMASI • SWIVEL PLATE - TURNABLE TABLE MECHANISM

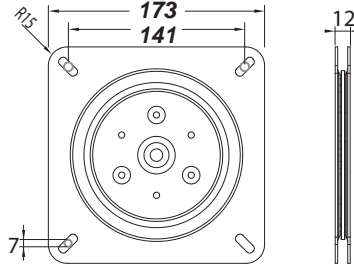

Kod / Code No	Açıklama / Description	L/W mm	Renk / Colour	Birim / Unit		
142-0060-1300	Döner Tabla Mekanizması / Swivel Plate - Turnable Table Mechanism	173 x 173 mm H:12 mm	Galvaniz / Galvanized	1 Adet / 1 Pcs	10	1.280

TurnTable 61 • DÖNER TABLA MEKANİZMASI • SWIVEL PLATE - TURNABLE TABLE MECHANISM

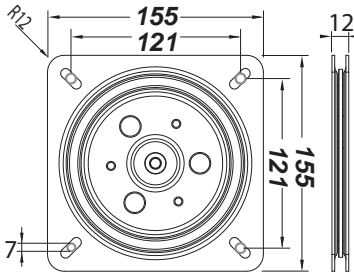

Kod / Code No	Açıklama / Description	L/W mm	Renk / Colour	Birim / Unit		
142-0061-1220	Döner Tabla Mekanizması / Swivel Plate - Turnable Table Mechanism	155 x 155 mm H:12 mm	Siyah / Black	1 Adet / 1 Pcs	10	1.280

TurnTable 62 • DÖNER TABLA MEKANİZMASI • SWIVEL PLATE - TURNABLE TABLE MECHANISM

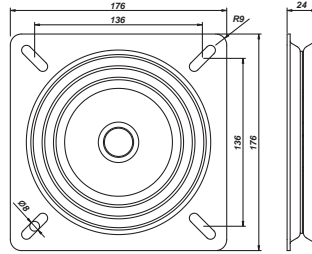

Bilgi / Information

- Ürününüz ölçüsel olarak güncellenmiştir.
- Dimension of our product has been updated.



Kod / Code No	Açıklama / Description	L/W mm	Renk / Colour	Birim / Unit		
142-0062-1220	Döner Tabla Mekanizması / Swivel Plate - Turnable Table Mechanism	176 x 176 mm H:24 mm	Siyah / Black	1 Adet / 1 Pcs	5	640

TurnTable 65 • DÖNER TABLA MEKANİZMASI • SWIVEL PLATE - TURNABLE TABLE MECHANISM

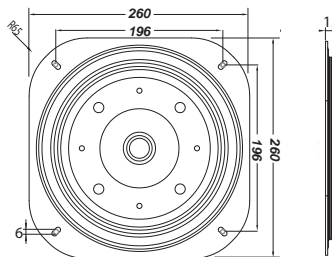

Kod / Code No	Açıklama / Description	L/W mm	Renk / Colour	Birim / Unit		
142-0065-1300	Döner Tabla Mekanizması / Swivel Plate - Turnable Table Mechanism	260 x 260 mm H:12 mm	Galvaniz / Galvanized	1 Adet / 1 Pcs	10	800

TurnTable

DÖNER TABLA MEKANİZMASI • SWIVEL PLATE - TURNABLE TABLE MECHANISM

TurnTable 67 • DÖNER TABLA MEKANİZMASI • SWIVEL PLATE - TURNABLE TABLE MECHANISM

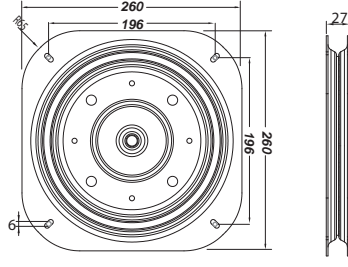
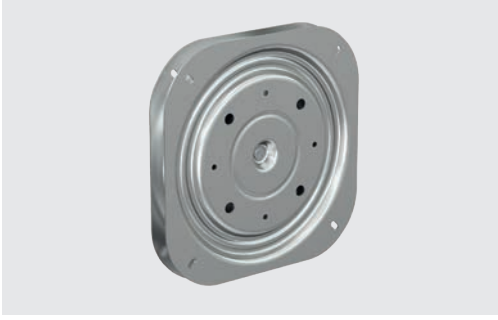

Kod / Code No	Açıklama / Description	L/W mm	Renk / Colour	Birim / Unit		
142-0067-1300	Döner Tabla Mekanizması / Swivel Plate - Turnable Table Mechanism	260 x 260 mm H:27 mm	Galvaniz / Galvanized	1 Adet / 1 Pcs	5	400

TurnTable 68 • DÖNER TABLA MEKANİZMASI • SWIVEL PLATE - TURNABLE TABLE MECHANISM

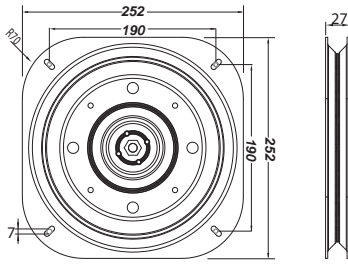
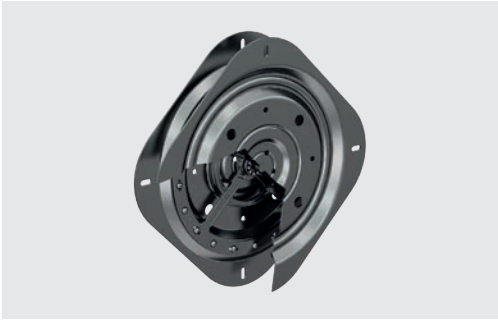

Kod / Code No	Açıklama / Description	L/W mm	Renk / Colour	Birim / Unit		
142-0068-1220	Döner Tabla Mekanizması / Swivel Plate - Turnable Table Mechanism	252 x 252 mm H:27 mm	Siyah / Black	1 Adet / 1 Pcs	5	240

TurnTable 70 • KONUM SABİTLEYİCİ • SWIVEL LOCATION STABILIZER

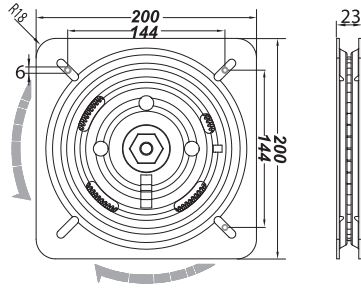

Kod / Code No	Açıklama / Description	L/W mm	Renk / Colour	Birim / Unit		
142-0070-1220	Konum Sabitleyici / Swivel Location Stabilizer	200 x 200 mm H:23 mm	Siyah / Black	1 Adet / 1 Pcs	6	288

TurnTable 75 • DÖNER TABLA MEKANİZMASI • SWIVEL PLATE - TURNABLE TABLE MECHANISM

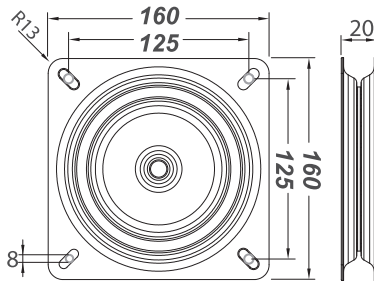

Kod / Code No	Açıklama / Description	L/W mm	Renk / Colour	Birim / Unit		
142-0075-1220	Döner Tabla Mekanizması / Swivel Plate - Turnable Table Mechanism	160 x 160 mm H:20 mm	Siyah / Black	1 Adet / 1 Pcs	5	480

■ 143-1000 • PANEL BİLEŞENİ • PANEL COMPONENT

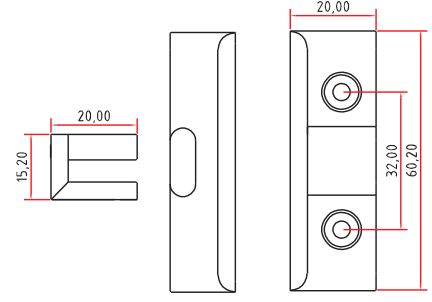

Kod / Code No	Renk / Colour	Br. / Unit		
143-1000-1630	Siyah / Black	1 Adet / 1 Pcs	100	6000

■ 143-1010 • PANEL BİLEŞENİ • PANEL COMPONENT

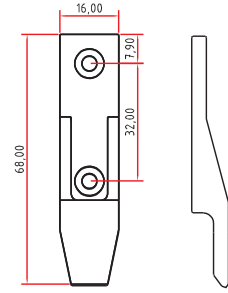

Kod / Code No	Renk / Colour	Br. / Unit		
143-1010-1630	Siyah / Black	1 Adet / 1 Pcs	100	6000

■ 143-1020 • PANEL BİLEŞENİ • PANEL COMPONENT

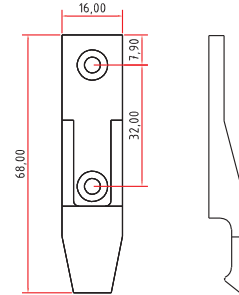

Kod / Code No	Renk / Colour	Br. / Unit		
143-1020-1630	Siyah / Black	1 Adet / 1 Pcs	100	6000

■ 143-1030 • PANEL BİLEŞENİ • PANEL COMPONENT

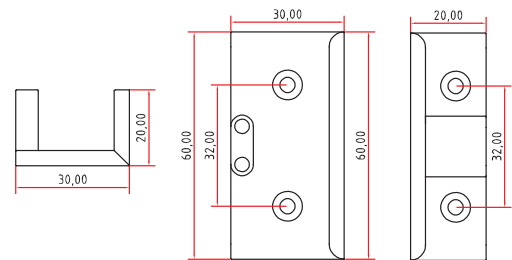

Kod / Code No	Renk / Colour	Br. / Unit		
143-1030-1630	Siyah / Black	1 Adet / 1 Pcs	100	6000

■ 143-1040 • PANEL BİLEŞENİ • PANEL COMPONENT

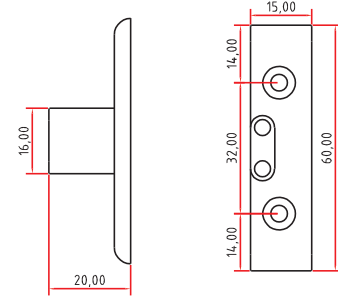

Kod / Code No	Renk / Colour	Br. / Unit		
143-1040-1630	Siyah / Black	1 Adet / 1 Pcs	100	6000

■ 143-1050 • PANEL BİLEŞENİ • PANEL COMPONENT

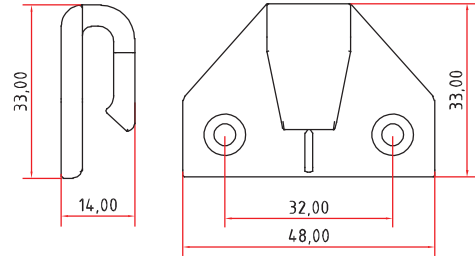

Kod / Code No	Renk / Colour	Br. / Unit		
143-1050-1630	Siyah / Black	1 Adet / 1 Pcs	100	6000

■ 143-1060 • PANEL BİLEŞENİ • PANEL COMPONENT

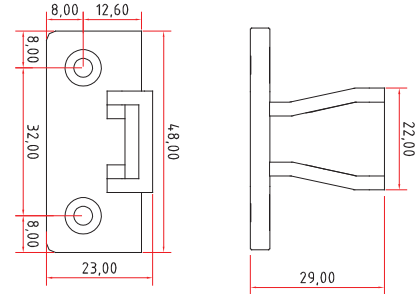
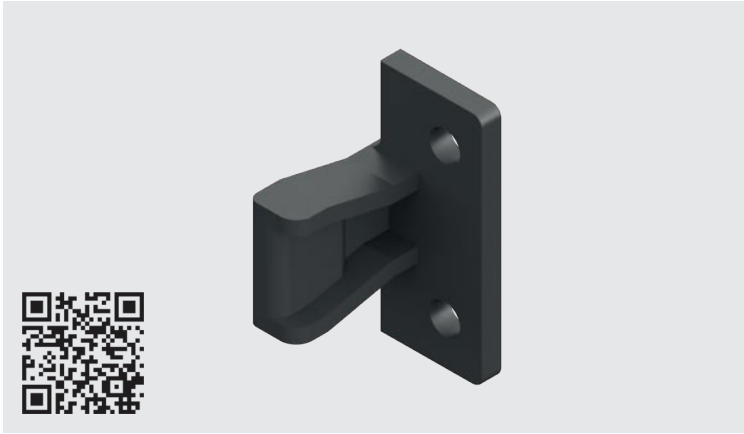

Kod / Code No	Renk / Colour	Br. / Unit		
143-1060-1630	Siyah / Black	1 Adet / 1 Pcs	100	6000

■ 143-1070 • PANEL BİLEŞENİ • PANEL COMPONENT

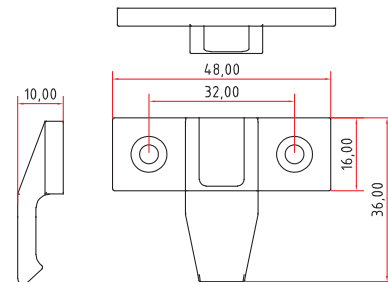

Kod / Code No	Renk / Colour	Br. / Unit		
143-1070-1630	Siyah / Black	1 Adet / 1 Pcs	100	6000

Çalışma Koşulları

WORKING CONDITIONS

■ Genel Bilgiler

- Ürünlerimiz; patentli, faydalı model ve endüstriyel tasarım tescil belgelidir.
- Fiyatlarımıza KDV dahil değildir.
- ALBATUR önceden haber vermeksizin fiyat ve satış şartlarını değiştirme hakkını saklı tutar.
- Her yeni fiyat listesi bir öncekini geçersiz kılar.
- Siparişini teyid ederek kesinleşmiş müşterimiz, çalışma koşullarımızı kabul etmiş sayılır.
- Bu fiyat listesinde oluşabilecek tipografik hatalardan firmamız sorumlu değildir.
- ALBATUR önceden haber vermeksizin ürünlerinde dizayn, renk ve hammadde özelliklerini değiştirme hakkını saklı tutar.
- Ürün broşürümüzde, albaturas.com web sitemizde ve kataloglarda verilen teknik ölçüler tavsiye niteliğinde olup, ür-ge sonrasında değişkenlik gösterebilir.
- ALBATUR 'un yazılı izni olmadan katalog ürünlerine ait herhangi bir görüntü kopyalanamaz veya kullanılamaz.
- Ürün paketlemelerinde koli, bağ, palet ölçü ve miktarlarını değiştirme hakkımız saklıdır.
- Firmamız sistemin bir parçası olan ürünlere ilişkin teklî satış yapmama hakkına sahiptir.
- Ödemesi alınmamış siparişler için sevk günündeki fiyatlar geçerlidir.

■ Sipariş Alış Düzeni ve Sevkiyat Düzeni

- Siparişler, yazılı olarak mail veya fax yoluyla firmamıza ulaştırılmalı ve teyid almalıdır. Aksi durumda oluşabilecek zarar ve gecikmeden firmamız sorumlu değildir.
- Koli, kutu ve paketleme adetlerine uygun olarak siparişler verilmelidir. Aksi durumda gelen siparişler bağ ve koliye tamamlanmaktadır.
- Stokta bulunmayan ürünler için hammadde tedariki yapılır ve üretim planına alınır.
- Özel siparişlerde ödeme alındıktan sonra üretim yapılır.
- Özel siparişlerde teknik detaylar, renk ve ölçü tam olmalıdır. ALBATUR'dan kaynaklanabilecek kusur dışında iade kabul edilmez.
- Siparişler ödeme önceliği ve sipariş tarihi dikkate alınarak sevk edilir.

■ Ödeme Düzeni

- Satışlarımız kredi kartı, havale veya DBS Sistemiyle ile tahsil edilir.
- Ödemesi alınmayan siparişler sevk edilemez.
- Karşılıksız çeklerin ödemesi 7 günü geçtiği takdirde aylık %3 finansman farkı uygulanır.
- Tüm siparişlerde sipariş bedelinin ödenmesi öncelikli edim olup, sipariş miktarının tümünün veya bir kısmının teslim edilmediği gerekçesi ile ödeme yapmaktan imtina edilemez.
- Siparişlerin sevk edilen tutarı kadar tahsilat yapılır. Sipariş miktarının tamamlanması istenilerek ödemeler şarta bağlanmaz.
- Siparişlerde; ALBATUR kataloğundaki sipariş kodu, varsa rengi, ölçüleri eksiksiz ve tam olmalıdır.

■ Nakliye Düzeni

- Ürünlerin teslim yeri Bursa'daki üretim tesisleridir.
- Müşteri ile karşılıklı mutabık kalınan kargo veya nakliye firmalarına verilmiş mallar müşteriye teslim edilmiş sayılır.
- Siparişlerin, nakliye bedeli ve sorumluluğu müşteriye aittir. Nakliye sırasında doğacak aksaklıklardan ALBATUR sorumlu tutulamaz.
- Müşteri tarafından nakliye şirketi belirtilmediği takdirde, anlaşmalı olduğumuz nakliye firmaları ile sevkiyat yapılmaktadır.
- İstenildiği takdirde ürünler müşteri adına bedeli mukabili sigorta ettirilebilir.
- Müşterimiz, ürünlerini nakliye şirketinden teslim alırken eksik veya hasar durumunu mutlaka kontrol etmelidir. Eğer bir aksaklık var ise nakliye görevlisine o anda tutanak tutturmalıdır. Teslimat fişi imzalandıktan sonra nakliye şirketleri hasar tazmini yapmamaktadır. Müşteri, hasarını nakliye şirketinden talep etmelidir. Tutanağı düzenlenmiş eksik veya hasarlı ürün teslimlerindeki sigorta konularında gerekli bilgilendirme, talep edilmesi durumunda firmamızdan alınabilir.

■ İade Düzeni

- İmalat hatalı ürünler ALBATUR'a bildirilmeli ve onayı alınarak 15 gün içinde iade edilmelidir. İade edilmeyen ürünler tekrar geri alınmaz ve değiştirilemez. İade edilecek ürünler ALBATUR'un anlaşmalı kargo veya nakliye firmaları ile yapılmalıdır.
- Sistem ürünlerimizin tüm parçaları firmamızdan temin edilmeyen ürünlerde yaşanabilecek aksaklıklardan firmamız sorumlu değildir.
- Siparişe özel üretilen ürünler iade alınmaz.
- Ürün modeli, dizaynı değişmiş veya listeden çıkarılmış ürünler iade alınmaz.
- İade gönderilmeden önce firmamızdan iade onayı alınmalıdır. Onay alınmayan ve önceden bilgisi verilmeden gönderilen iade ürünlerin firmamızca giriş kabulü yapılmaz.

SETBOX

PAKETLEME • PACKAGING

STANDART PAKETLEME / STANDARD PACKAGING



Standart Sevkiyat Düzenimiz ;

Mekanizma ve ray profilleri, ürüne göre değişen bağ ve koli adetlerinde müşterilerimize sevk edilmektedir.

Standard shipment process ;

Mechanism and rail profiles are packaging and shipping to our customers in changing laps and carton ties and parcels various according to the product.

SETBOX PAKETLEME / SETBOX PACKAGING



Değerli İş Ortağımız ;

Sizlere yeni hizmetimiz SETBOX'ı tanıtmak istiyoruz. Paketleme ve sevkiyat süreçlerinize hız katacağını düşündüğümüz SETBOX sistemi, tek paket içerisinde 1 dolaplık ürünü içermektedir.

SETBOX Paketleme ;

Sürme sistemler için düşünülmüş bu paketleme modelinde, ray profilleri ve mekanizma tek karton ambalaj içerisinde, köpüklerle desteklenmiş olarak 1 set halinde sevk edilmektedir.

Kısaca ; Dolap için 1 setbox içerisinde ; 2 kapak mekanizma + üst ray + alt ray bulunmaktadır.

Neden SETBOX ;

- Bildiğiniz gibi sürgü sistemleri çok bileşenli ürünlerdir. Tek paketleme sayesinde hatasız ve noksanız sevkiyat gerçekleştirilebilir.
- Depolama açısından kolaylık sağlar.
- Değişken ve benzer ray profillerindeki stok karışıklığını önler. Stoklama maliyetlerinizi düşürür.
- Sevkiyat hazırlık sürenizi kısaltır.
- Ürünlerinizi koli ve köpük ambalajı sayesinde daha uzun süreli muhafaza edebilir ve dış darbelerle göre koruyabilirsiniz.
- İnternet üzerinden E-satış yapan firmalar için sevkiyat kolaylığı sağlar.

Detay Bilgiler ;

- Farklı boy ve ürün seçenekleri sebebiyle ürünler siparişe özel paketlenmektedir.
- Stokta hazır ürün bulunmamaktadır.
- Ray boyları 2 mt , 2.5 mt, 3 mt olarak uygulanabilir.
- Kapılarda 1 kapı sistemi ve üst ray paketlenir. İstenirse alın kapama profili paket içerisine ilave edilebilir.
- Setbox sistemi ürün fiyatı üzerine paket maliyeti eklenerek sunulur.

Ürüne özel minimum paketleme miktarı ve fiyat teklifi için müşteri temsilciniz ile temasa geçebilirsiniz.

Dear Business Partner ;

We would like to introduce our new service SETBOX. SETBOX system which we think will add speed to your packaging and shipment process, includes 1 set sliding systems product in one package

SETBOX Packaging ;

In this packaging model for sliding systems , will be shipping 1 set mechanism with rail profiles and inside one carton package and supporting with foam.

Shortly; For wardrobe 1 setbox including ; 2 door mechanism + Top rail + bottom rail

Why SETBOX ;

- As you know, sliding systems are multi-component products
- Easy to storage
- Its prevent to stock confusing for similar and variable profiles. It will reduce of your stocking cost
- Will be positive effect and will be shorten to your shipment time
- You can protect your products for longer periods of time and protect them against to external damage because of carton and foam packaging
- Setbox product give advantage for shipment in online sales

Detailed Informations ;

- The orders can be make special packaging because of different size product and mechanism
- There is no ready product in our stock
- Rail size can be apply 2 mt , 2.5 mt , 3 mt
- For door , 1 door mechanism and Top rail packaging together. If need Closure Profile can be add inside the setbox
- Setbox system product included packaging cost.

You can contact your customer representative for special product minimum specific packaging and price offer.



Önemli Notlar

IMPORTANT NOTES

1. Sürgü Sistem mekanizmaları ve üretimini gerçekleştirdiğimiz tüm Albatur markalı ürünler sistem bileşenleri ile birlikte tasarlanmaktadır. Ürünlerimizde müşteri memnuniyetinin üst seviyede karşılanması için, sürgü sistem ve diğer üretimini gerçekleştirdiğimiz ürünlerin set halinde ALBATUR markalı olarak kullanılmasını tavsiye ederiz.
2. Sistem elemanlarının "Muadil" ürünler kullanılarak montajlanması durumunda karşılaşılabilecek sorunlardan firmamız sorumlu değildir.
3. Sürgü sistemlerinde her kapak için belirlenmiş taşıma ağırlıklarının aşılması önemlidir. Sistemin taşıma ağırlığından fazla yük yüklenmesi sürgü sisteminize zarar verebilir.
4. Süreme sistemlerin stabil çalışması ve ürünlerinizin uzun ömürlü kullanımı için dolabınızın teraziye olması önemlidir. Sürgü sistemler hassas ölçülerde çalışmaktadır. Kurulum esnasında bu konuda hassasiyet gösterilmesini tavsiye ederiz.
5. Dolaplarınızın üretimi ve montajı esnasında sürgü sistem teker gruplarının darbeye maruz kalmaması çok önemlidir. Aksi halde teker yüzeyinde veya ray profilleri üzerindeki deformasyonlar kullanıcı memnuniyetini azaltabilir.
6. Teker sistemi ray profiline takılmadan önce, çapak ve benzeri yüzey kirlerinin temizlenmesi ve silinerek montaj edilmesi tavsiye edilir. Aksi durumda mekanizma üzerindeki yabancı malzemeler ray profil yüzeyine zarar verebilir.
7. Ray profillerinin kanal aralarına girebilecek toz vs yabancı cisimler elektrikli süpürge yardımıyla veya kuru bez ile temizlenmesi tavsiye edilir. Temizlenmemesi durumunda bu kalıntılar tekerlek yüzeyine zarar verebilir.
8. Sürgü sistemlerinde en sık karşılaşılan çalışma problemi, firmamıza ait ürünün hatalı olmasından kaynaklanmayan kapaklarda kullanılan doğal ahşap malzemelerin evsafından ve dış etkenlerden kaynaklı olarak değişim göstermesi ve kapakların birbirine temas etmesidir. Bu türden problemleri en başından engellemek için süreme kapaklarınızda kapak gergi sistemleri kullanmanızı tavsiye ederiz.
9. Yavaşlatıcı mekanizmalar ve entegre çalışan yavaşlatıcılı sürgü sistem mekanizmalarının oda sıcaklığında muhafaza edilmesi tavsiye edilir. Piston gövdelerinin aşırı soğuk veya sıcakta maruz kalması ürün performansını olumsuz etkiler.
10. Ürünlerimizin montajında, Yavaşlatıcı sistemlerin montaj öncesinde kurulması önemle tavsiye edilir. Kurulmadan montaj edilmesi durumunda yavaşlatıcıların aktivatör yakalama dili zarar görebilir. Bu sebepten montaj esnasında zarar gören ürünler garanti kapsamı dışındadır.
11. Süreme sistemlerinde harici ve entegre olarak kullanılan yavaşlatıcı mekanizmaların montaj talimatına uygun gerçekleştirilen aktivatör montajı, sistemin sağlıklı ve sorunsuz çalışması için önemlidir. Web sitemizde bulunan teknik dokümanlarımızdan ve ürün kurulum videolarımızdan, tercih ettiğiniz Albatur markalı ürünler için destek alabilirsiniz.
12. Metal TV altlıklarında ürünün taşıma kapasitesinin üzerinde yük yüklenmemesi gerekmektedir. Fazla yük ürünün çalışma prensibine zarar verebilir.
13. Tüm ürünlerimizde montaj talimatına mutlaka uyulması gerekmektedir.
14. Ürünlerimizin montajı esnasında uygulanan yanlış yöntemlerden dolayı yaşanacak hatalardan firmamız sorumlu değildir. Ürünlerimizin kurulumu esnasında dikkat edilmesi gereken hususlar web sitemizde bulunan teknik doküman ve videolarda mevcuttur. Kurulumla başlamadan önce ürüne ait video ve dokümanları incelemenizi tavsiye ederiz.
15. Müşteri tarafından talep edilen ve Albatur tarafından özel üretim yapılan ürünler (üretim hatalı olması dışında) iade alınmaz.
16. Ürünlerimizle ilgili yedek parça taleplerinde kalite yönetim sistemimiz gereğince, üründen hata varsa tespit edebilmek ve kalıcı aksiyon alabilmek adına parçaların firmamıza ulaştırılması gerekmektedir. Aksi durumda yeni parçalar fatura edilerek sevk edilir.
17. Ürünlerimizin demontaj yapılarak kullanılması durumunda yaşanacak problemlerden firmamız sorumlu değildir.
18. Ürünlerimiz iç mekan yaşam alanları için tasarlandığından bu ortamlarda kullanılması tavsiye edilir. Dış mekanlarda kullanılacak ürünler için satış ekiplerimizle temasa geçebilir ve teknik bilgi talep edebilirsiniz.
19. Albatur ürünleri, sadece önceden boyanmış, boyası tamamen kurumuş zemin ve ortamlarda montaj edilmelidir. Ayrıca önemle bilinmelidir ki; bazı kimyasal temizlik malzemelerinin kullanımı (deterjan, asit, alkol ve çözücüler vb ..) yüzey kaplamalarına ve mekanizmaya zarar verebileceği için kesinlikle tavsiye edilmez.
20. Albatur gerekli gördüğü zamanda ve durumda, önceden haber vermeksizin ürünlerde ölçü, renk, şekil değişikliği yapma hatta modeli tamamen üretimden kaldırma hakkına sahiptir.
21. Bu kataloğun tüm çoğaltma hakları Albatur Endüstri A.Ş.'ne aittir. İzinsiz çoğaltılamaz.
22. Baskıdan kaynaklanan hatalardan Albatur Endüstri A.Ş. sorumlu değildir.
23. Resimler örnek görüntüler olabilir ve/veya teslim edilecek ürün görselinden farklı bir görünüme sahip olabilir.
24. Kataloğumuzda ve web sayfamızda verilen teknik tanımlar, ölçüler ve çizimler bağlayıcı değildir. Önerilen kurulum ölçüleridir. Albatur ürün özelliklerinde haber vermeden değişiklik yapabilir.
25. Ürünlerimiz hakkında ürün detaylarına ve teknik çizimlere www.albaturas.com daki ürün sayfalarımızdan ulaşabilirsiniz.
26. Katalog sayfalarımızdaki qr-code 'ları akıllı cihazlar ile tarayabilir ve web üzerindeki ürün sayfasına, teknik çizimlere ve videolara ulaşabilirsiniz.

1. Sliding System mechanisms and all Albatur branded products that we produce are designed together with system components. For the keep customer satisfaction at the highest level in our products, we recommend that the sliding system and other products what we manufacturing be used as a set with Albatur brand
2. If the system fittings are assembled using «equivalent» products, our company is not responsible for the problems that may occur in this case
3. In sliding systems, it is important not to overlap the specified carrying weights for each door. Loading more than the carrying weight on the system can be damage your sliding system.
4. For the stable and well working of your sliding systems; its important to make good balance of your wardrobe. Sliding systems are working with sensitive dimensions. We recommend paying attention to this issue during installation.
5. It is very important that the sliding system wheels group are not exposed to impact during the production and installation of your cabinets. Otherwise, deformations on the wheels surface or rail profiles can decrease user satisfaction.
6. Before the assembly the wheels system on the rails, recommended to clean the burrs and dirt from the surface. Otherwise other foreign materials can be damage on the profile surface
7. It is recommended to clean rail profiles with a vacuum cleaner or duster for dust etc. objects that may get into between the channels. If not cleaned well, the residues may damage your wheels surface.
8. The most common working problem in sliding systems is that the natural wood materials used in the covers, which are not caused by the faulty product of our company, change due to the quality and external factors, and the covers come into touch with each other. In order to prevent such problems from the beginning, we recommend using door tensioning systems in your sliding doors.
9. It is recommended to keep all kind of the soft closer system mechanisms at room temperature. If leaving the pistons in extreme heat or cold condition ,will be decrease product performance.
10. In the installation of our products, highly recommended to assembly the soft closers before system installation.Soft closers activator's kit can be damage If the install before the assembly. For this reason, damaged products during assembly are out of warranty.
11. Activator installation performed in accordance with the installation instructions of soft closer mechanisms used externally and integrally in sliding systems is important for healthy and trouble-free use of the system. You can get support for your preferred Albatur branded products from our technical prospectus and product installation videos on our website.
12. In the Metal Tv turnable system , should not be load more than carrying capacity. Overload can be damage working principle of the products.
13. Installation instructions must be followed in all our products.
14. Our company is not responsible for the mistakes that may occur due to the wrong methods application during the assembly of our products. Technical documents and related product assembly videos are available in on our website regarding the points that considered during the installation of our products.
15. Special products produced by Albatur with customer request are not returned.(Except for a production faulty)
16. In accordance with our quality management system for the spare part requests related to our products, the fault parts must be delivered to our company in order to detect if there is a fault in the product and for take permanent action.
17. Our company is not responsible for the problems will be happening if our products are used by disassembly.
18. Our products are designed for indoor living spaces, so its recommended to be used in these areas. Products to use for outdoors, you can contact our sales teams and request technical information.
19. Albatur products should only be installed on pre-painted or completely dried floors and environments. It should be known that; the use of some chemical cleaning materials (detergents, acid, alcohol and solvents etc.) is absolutely not recommended as it can damage surface coatings and mechanism.
20. Albatur reserves the right to change the sizes, colors and shape of the products at any time and in case it deems necessary, or even to remove the model completely from the production.
21. All reproduce of this catalog rights are reserved by Albatur Industry Inc. It can't be reproduced without permission.
22. Albatur Industry Inc. is not responsible for printing mistakes.
23. Pictures are can be sample images and/or may will be differnet view the product from the picture of to be delivered.
24. Technical definitions, dimensions and drawings given in our catalog and on our website are not binding. its recommended installation dimensions. Albatur can make changes in the products specifications without notice.
25. You can reach to detailed information about our products and technical drawings of our products on our website www.albaturas.com
26. You can scan the qr-codes in our catalog pages with your smart devices and access the product page, technical drawings and videos on the website.

Stand

ÜRÜN TEŞHİR STANDLARI • PRODUCT DISPLAY STANDS

■ 190-0032 • DUVAR TİPİ BÜYÜK STAND • WALL MOUNT STAND



■ Teknik Detay / Technical Detail

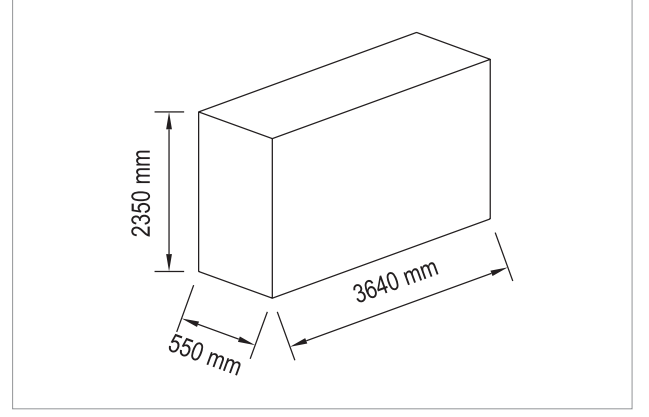

■ 190-0027 • PRATİK STAND • PRACTICAL STAND



■ Teknik Detay / Technical Detail

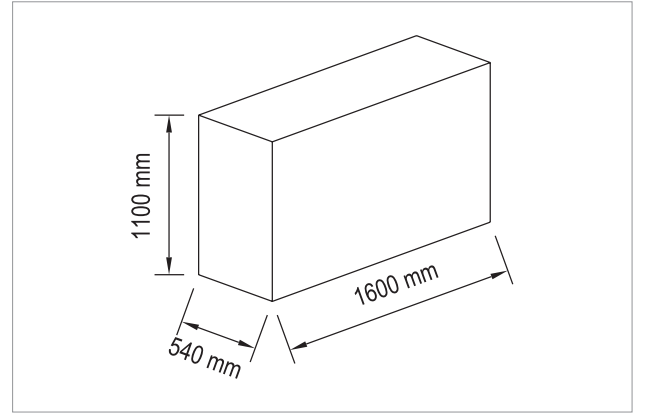

■ 190-0035 • ÜRÜN STAND • PRODUCT STAND



■ Teknik Detay / Technical Detail

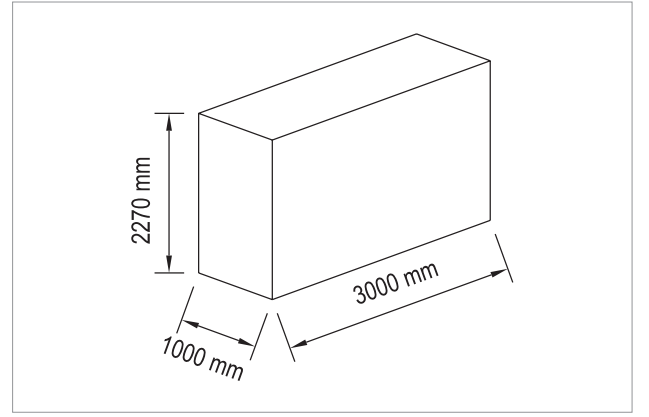

■ 190-0035 • DUVAR TİPİ BÜYÜK STAND • WALL MOUNT STAND



■ Teknik Detay / Technical Detail

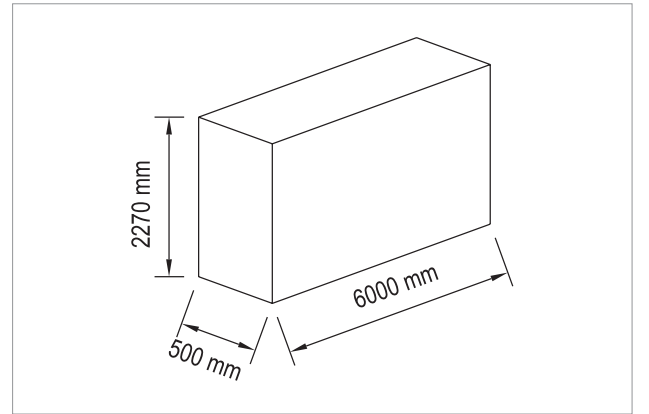

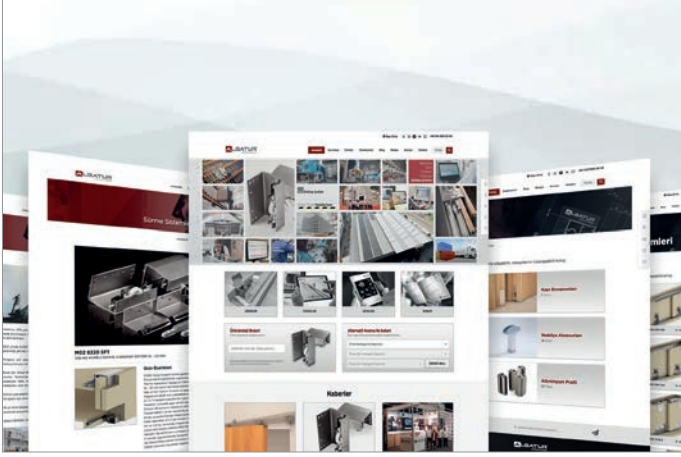

Sürekli güncellenen web sitemizde, ürünlerimizle ilgili ayrıntılı teknik bilgilere ulaşabilir, ürünlerimizin montaj videolarını izleyebilirsiniz. Ürün broşürümüzü inceleyebilir, güncel yeni ürün ve haberleri takip edebilirsiniz.

In our constantly updated website, you can reach more detailed technical information and you can watch installations videos of our products. You can see our product brochure and you can follow new products and news.

■ albaturas.com



Ürünlerimizin kolay ve rahat kurulumunu sağlayabilmek için Albatour olarak montaj videoları hazırlıyoruz. Bu sayede dünyanın farklı köşelerindeki uygulayıcı profesyonellerimize ürünümüzü daha hızlı ve etkin bir şekilde tanıtmaya imkanı elde ediyoruz.

3D montaj videolarımıza
www.albaturas.com
www.youtube.com/albaturas,
vimeo.com/albaturas,
facebook sayfamızdan ulaşabilirsiniz.

In order to provide easy and pratic installation of our products, Albatour company prepares installation videos.In this way, we have the opportunity to introduce our product to our application professionals in different corners of the world faster and more effectively.

You can reach our 3D montage videos from our website
www.albaturas.com
www.youtube.com/albaturas,
vimeo.com/albaturas,
facebook page.

■ youtube.com/albaturas



 LBATUR produces quality	 ALB	 ALB GLOBAL	 Dormech door automation
 Québec	 windustop	 SRG	 SETBOX
THE Sliding System	TurnTable	Pulltens	Multiline
WingSlide	GlassDoor	MultiDoor	BarnDoor
Glassline	DoorSlide	TvSlide	Rigel
Coplanar	Softline	DoorSync	Underline
TopSlide	MasterFold	MagicLift	EasyDoor
Ventil ®Plastic	Ventil ®Aluminium	Momentum	Interline
Domino	Feet	Master+	 link+

