

Group 109

Rigel[®]

Sürme Ray Dolap Serisi
Sliding Rail Wardrobe Series

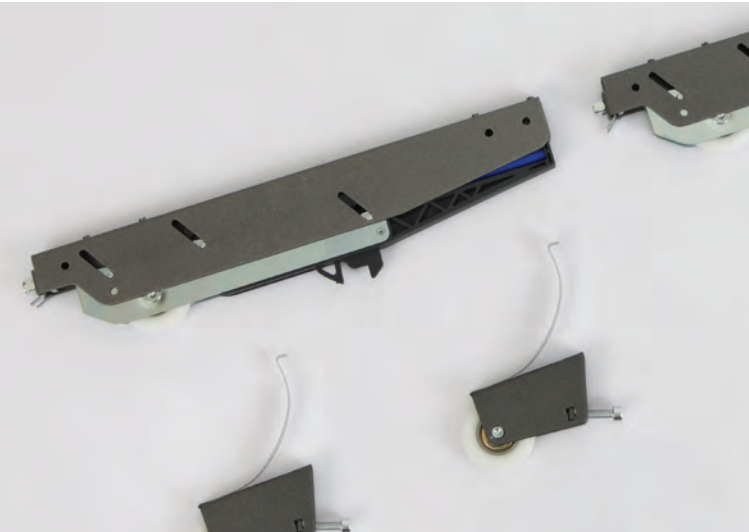

Bu serideki tüm ürünleri incelemek için QR kodu okutabilirsiniz.

You can search the QR code to see all the products in these series.

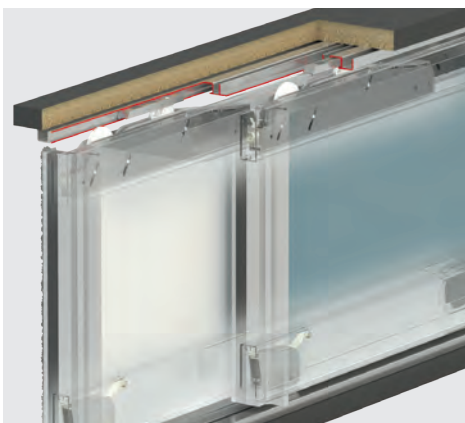

Rigel 1

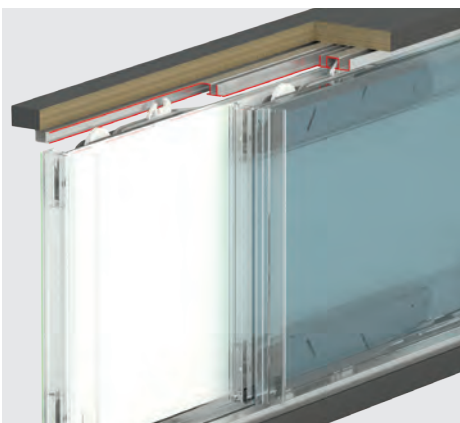

Rigel 2

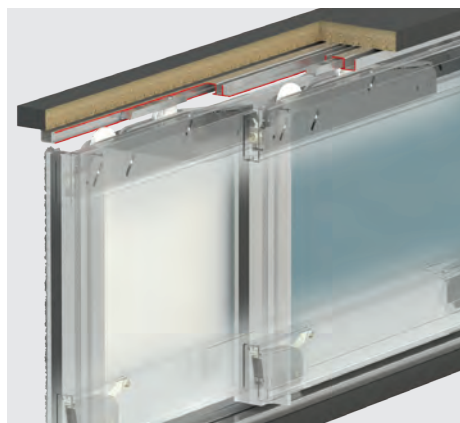

Rigel 3

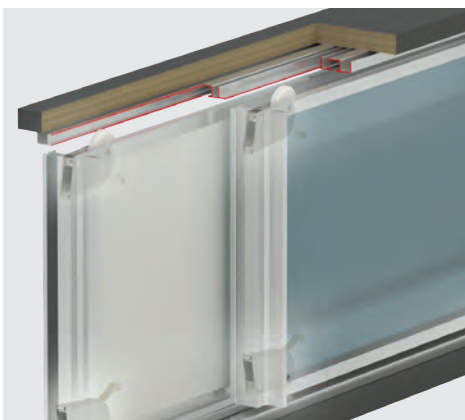

Rigel 4

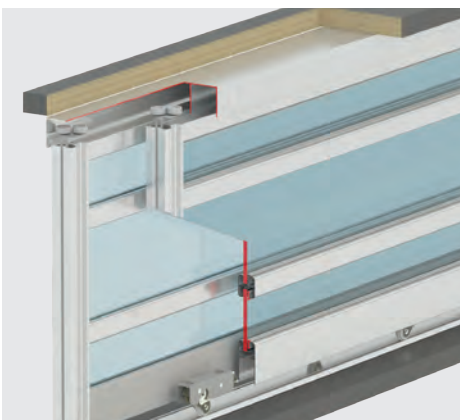

Rigel 1801

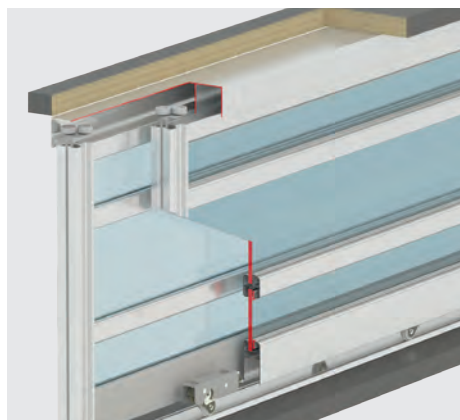

Rigel 1812

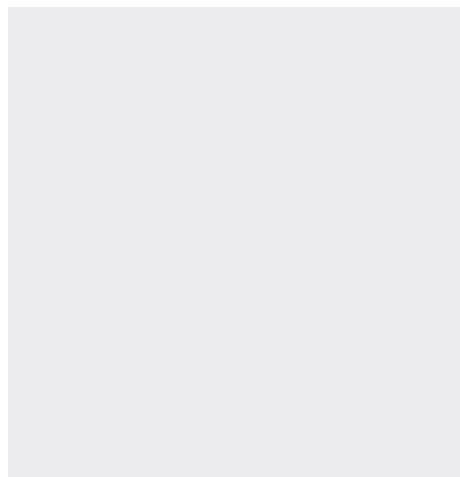
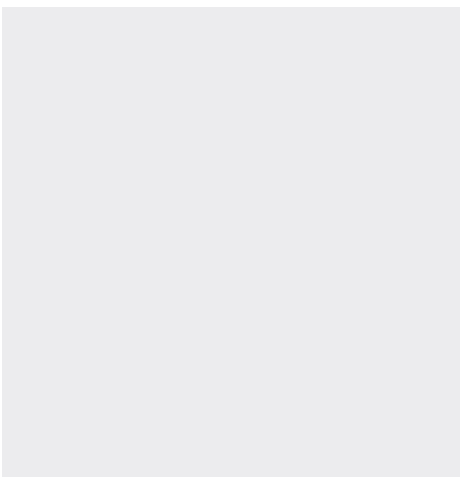
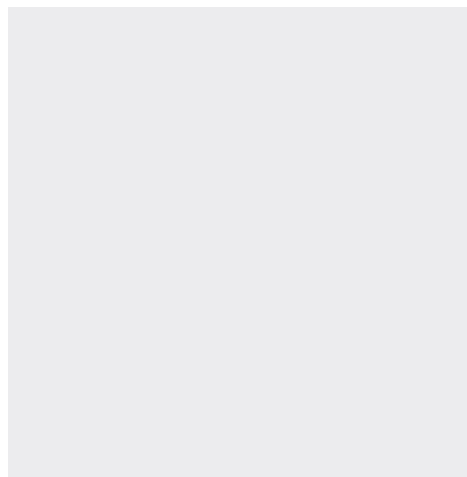
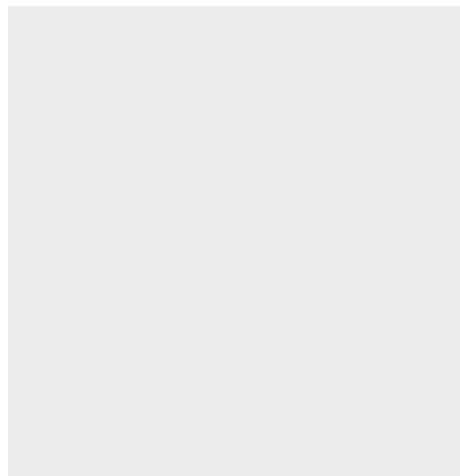
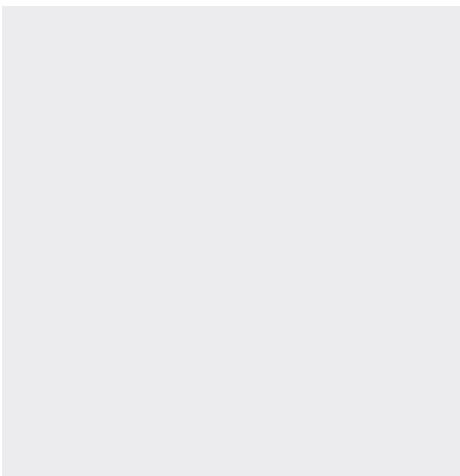
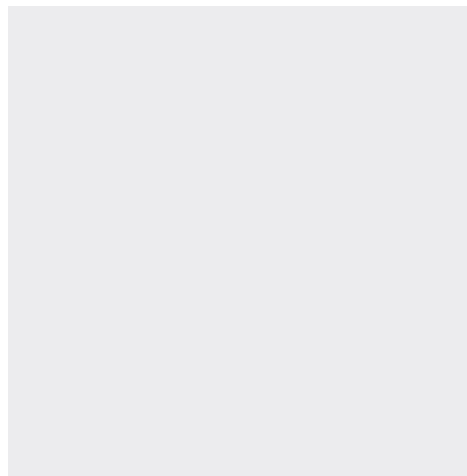

Rigel 1

50 KG SÜRME PANO SİSTEMİ • SLIDING PANEL SYSTEM

Yeni Ürün
New Product

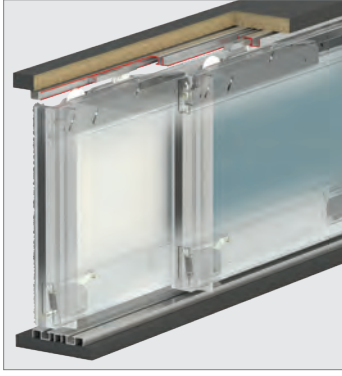

■ Yavaşlatıcı Alternatifi / Soft Closer Alternative

- Sistem üzerinde entegre yavaşlatıcı mevcuttur.
- The system has integrated soft closer.



■ 109-0251 1 Takım İçeriği / 1 Kit Includes

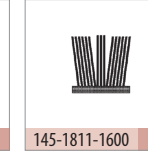
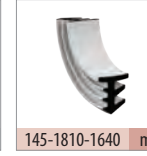
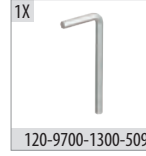
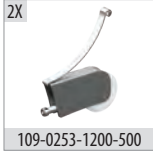
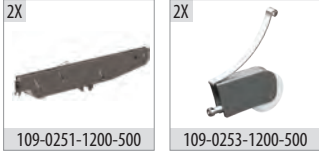

■ Ray Profilleri / Rail Profiles

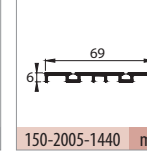
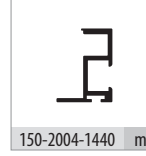
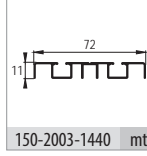
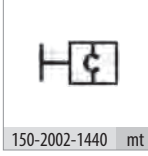
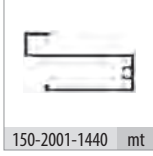
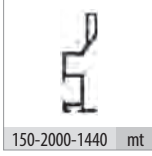

■ Teknik Detay / Technical Detail

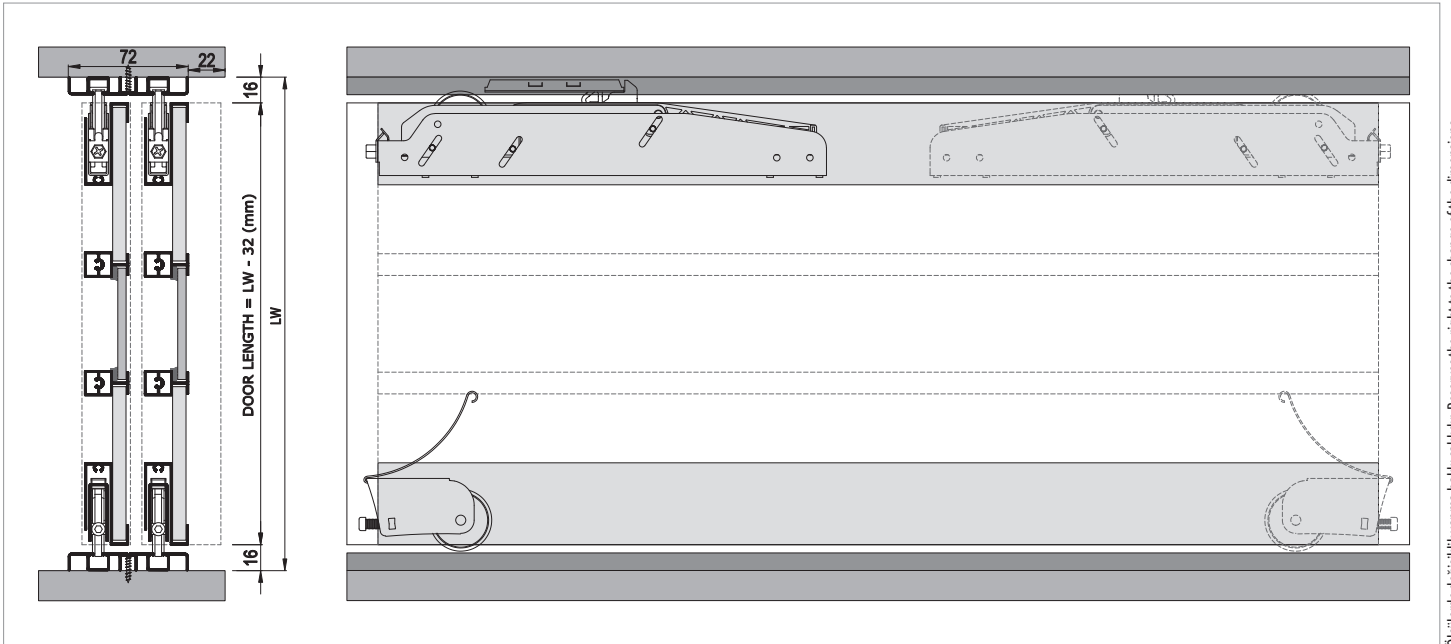

Ölçülerde değişiklik yapma hakkı saklıdır. Reserves the right to the change of the dimensions.

Kod / Code No	Açıklama / Description	Renk / Colour	Birim / Unit			Profil mt. / Profiles mt.	Bağ / Bnd.
109-0251-1200	RIGEL 1 - 50 Kg Sürme Pano Sistemi / 50 Kg Sliding Panel System	Silver	1 Kapak / 1 Kit	24	720	-	-
145-1810-1640	Kapama Fitolu / Closing Wick	Gri / Grey	mt.	100	3.600	-	-
145-1006-1673	Kapama Fitolu / Closing Wick	Gri / Grey	mt.	100	3.600	-	-
145-1811-1600	Kıl Fitolu / Ec-Wf Hair Wick	Gri / Grey	mt.	300	7.200	-	-
150-2003-1440	Alüminyum Ray Profili / Aluminium Rail Profile	Bronz Parlak / Bronze Bright	mt.	-	-	-	3,0 10 ad/pcs
150-2000-1440	Alüminyum Kulp Profili / Aluminium Handle Profile	Bronz Parlak / Bronze Bright	mt.	-	-	-	3,0 6 ad/pcs
150-2001-1440	Alüminyum Alt-Üst Kayıt Profili / Aluminium Bottom-Top Profile	Bronz Parlak / Bronze Bright	mt.	-	-	-	3,0 6 ad/pcs
150-2002-1440	Alüminyum Orta Kayıt Profili / Aluminium Horizontal Central Profile	Bronz Parlak / Bronze Bright	mt.	-	-	-	3,0 10 ad/pcs
150-2004-1440	Alüminyum Kulp Profili / Aluminium Handle Profile	Bronz Parlak / Bronze Bright	mt.	-	-	-	3,0 6 ad/pcs

Rigel 2

50 KG SÜRME PANO SİSTEMİ • SLIDING PANEL SYSTEM

Yeni Ürün
New Product

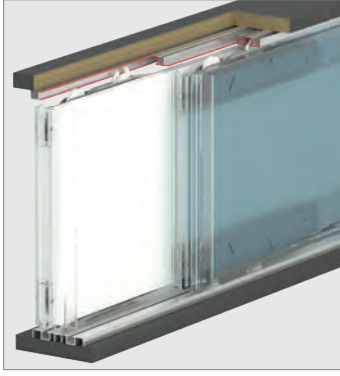

■ Yavaşlatıcı Alternatifi / Soft Closer Alternative

- Sistem üzerinde entegre yavaşlatıcı mevcuttur.
- The system has integrated soft closer.



■ 109-0252 1 Takım İçeriği / 1 Kit Includes



109-0251-1200-500

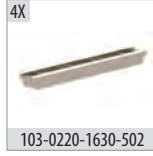

103-0220-1630-502

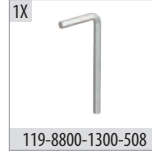

119-8800-1300-508

■ Alüminyum Fitilleri / Aluminium Wicks



145-1810-1640 mt



145-1006-1673 mt

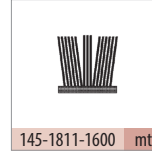

145-1811-1600 mt

■ Ray Profilleri / Rail Profiles

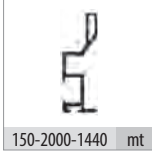

150-2000-1440 mt

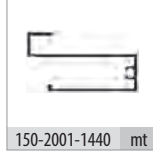

150-2001-1440 mt

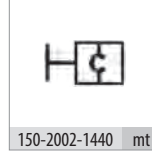

150-2002-1440 mt

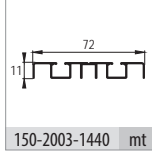

150-2003-1440 mt

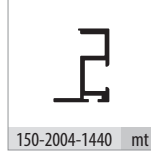

150-2004-1440 mt

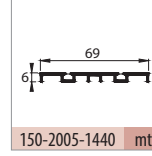

150-2005-1440 mt

■ Teknik Detay / Technical Detail

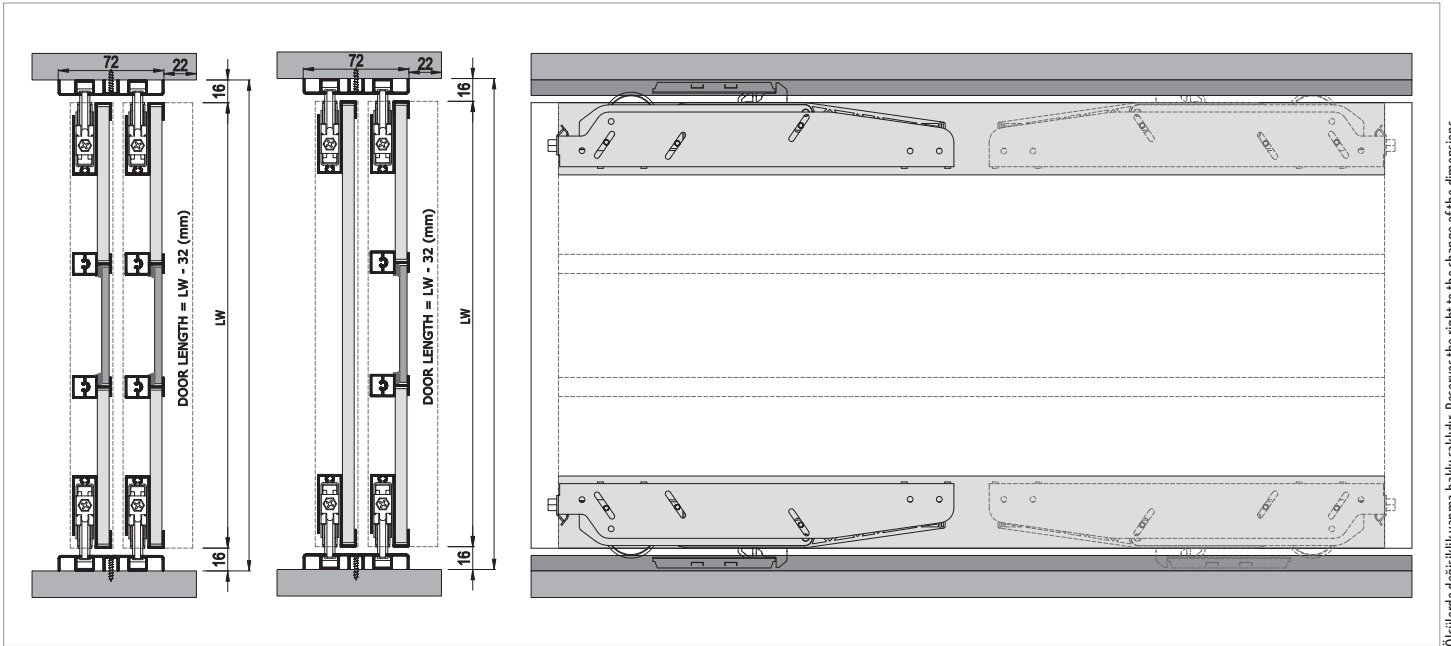

Ölçülerde değişiklik yapma hakkı saklıdır. Reserves the right to the change of the dimensions.

Kod / Code No	Açıklama / Description	Renk / Colour	Birim / Unit			Profil mt. / Profiles mt.	Bağ / Bnd.
109-0252-1200	RIGEL 2 - 50 Kg Sürme Pano Sistemi / 50 Kg Sliding Panel System	Silver	1 Kapak / 1 Kit	12	360	- - -	-
145-1810-1640	Kapama Fitili / Closing Wick	Gri / Grey	mt.	100	3.600	- - -	-
145-1006-1673	Kapama Fitili / Closing Wick	Gri / Grey	mt.	100	3.600	- - -	-
145-1811-1600	Kıl Fitil / Ec-Wf Hair Wick	Gri / Grey	mt.	300	7.200	- - -	-
150-2003-1440	Alüminyum Ray Profili / Aluminium Rail Profile	Bronz Parlak / Bronze Bright	mt.	-	-	- - 3,0	10 ad/pcs
150-2000-1440	Alüminyum Kulp Profili / Aluminium Handle Profile	Bronz Parlak / Bronze Bright	mt.	-	-	- - 3,0	6 ad/pcs
150-2001-1440	Alüminyum Alt-Üst Kayıt Profili / Aluminium Bottom-Top Profile	Bronz Parlak / Bronze Bright	mt.	-	-	- - 3,0	6 ad/pcs
150-2002-1440	Alüminyum Orta Kayıt Profili / Aluminium Horizontal Central Profile	Bronz Parlak / Bronze Bright	mt.	-	-	- - 3,0	10 ad/pcs
150-2004-1440	Alüminyum Kulp Profili / Aluminium Handle Profile	Bronz Parlak / Bronze Bright	mt.	-	-	- - 3,0	6 ad/pcs

Rigel 3

50 KG SÜRME PANO SİSTEMİ • SLIDING PANEL SYSTEM

Yeni Ürün
New Product

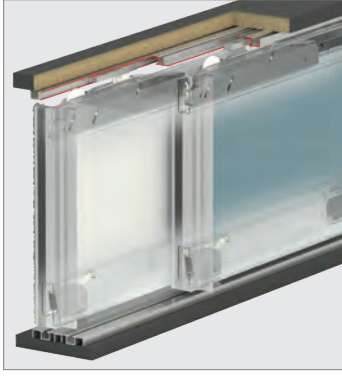

■ Yavaşlatıcı Alternatifi / Soft Closer Alternative

- Sistem üzerinde entegre yavaşlatıcı mevcuttur.
- The system has integrated soft closer.



■ 109-0253 1 Adet İçeriği / 1 Pcs. Includes

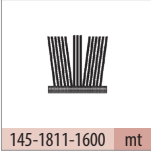
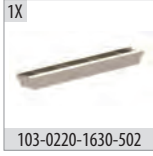

■ Ray Profilleri / Rail Profiles

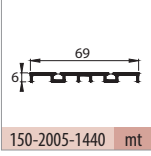
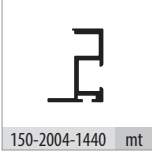
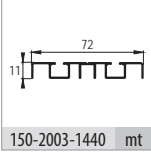
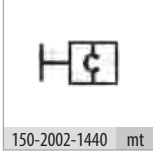
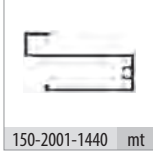
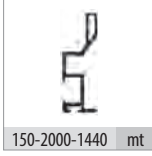

■ Teknik Detay / Technical Detail

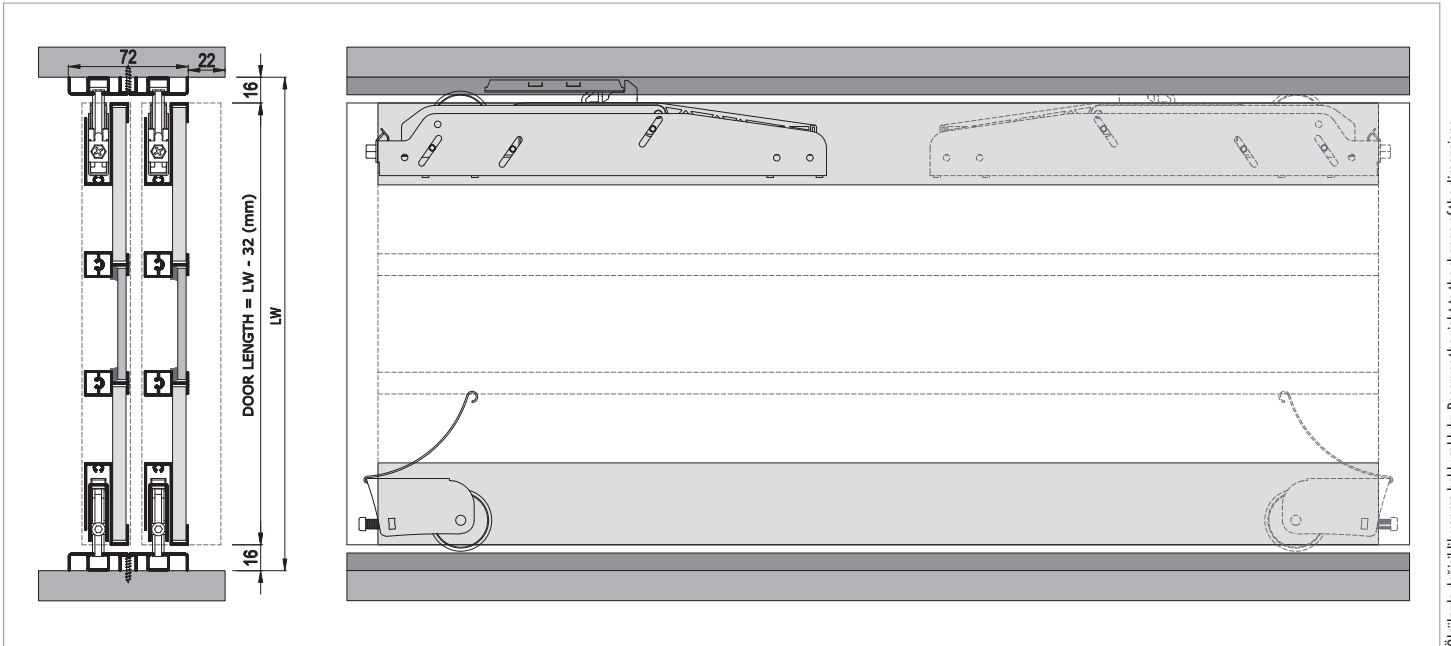

Ölçülerde değişiklik yapma hakkı saklıdır. Reserves the right to the change of the dimensions.

Kod / Code No	Açıklama / Description	Renk / Colour	Birim / Unit			Profil mt. / Profiles mt.	Bağ / Bnd.
109-0253-1200	RIGEL 3 - 50 Kg Sürme Pano Sistemi / 50 Kg Sliding Panel System	Silver	1 Adet / 1 Pcs	40	1.280	- - -	-
145-1810-1640	Kapama Fitolu / Closing Wick	Gri / Grey	mt.	100	3.600	- - -	-
145-1006-1673	Kapama Fitolu / Closing Wick	Gri / Grey	mt.	100	3.600	- - -	-
145-1811-1600	Kıl Fitolu / Ec-Wf Hair Wick	Gri / Grey	mt.	300	7.200	- - -	-
150-2003-1440	Alüminyum Ray Profili / Aluminium Rail Profile	Bronz Parlak / Bronze Bright	mt.	-	-	- - 3,0	10 ad/pcs
150-2000-1440	Alüminyum Kulp Profili / Aluminium Handle Profile	Bronz Parlak / Bronze Bright	mt.	-	-	- - 3,0	6 ad/pcs
150-2001-1440	Alüminyum Alt-Üst Kayıt Profili / Aluminium Bottom-Top Profile	Bronz Parlak / Bronze Bright	mt.	-	-	- - 3,0	6 ad/pcs
150-2002-1440	Alüminyum Orta Kayıt Profili / Aluminium Horizontal Central Profile	Bronz Parlak / Bronze Bright	mt.	-	-	- - 3,0	10 ad/pcs
150-2004-1440	Alüminyum Kulp Profili / Aluminium Handle Profile	Bronz Parlak / Bronze Bright	mt.	-	-	- - 3,0	6 ad/pcs

Rigel 4

50 KG SÜRME PANO SİSTEMİ • SLIDING PANEL SYSTEM

Yeni Ürün
New Product

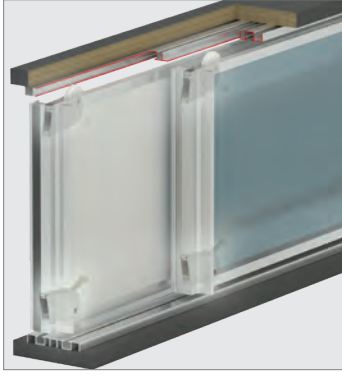

109-0254 1 Takım İçeriği / 1 Kit Includes

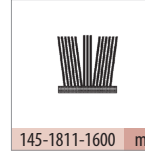
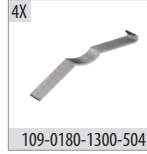
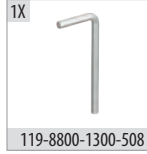

Alüminyum Fitilleri / Aluminium Wicks

Ray Profilleri / Rail Profiles

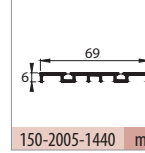
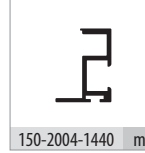
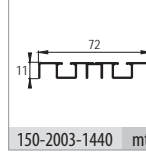
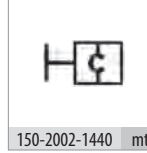
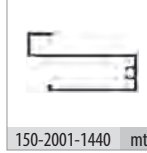
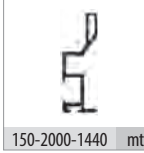

Teknik Detay / Technical Detail

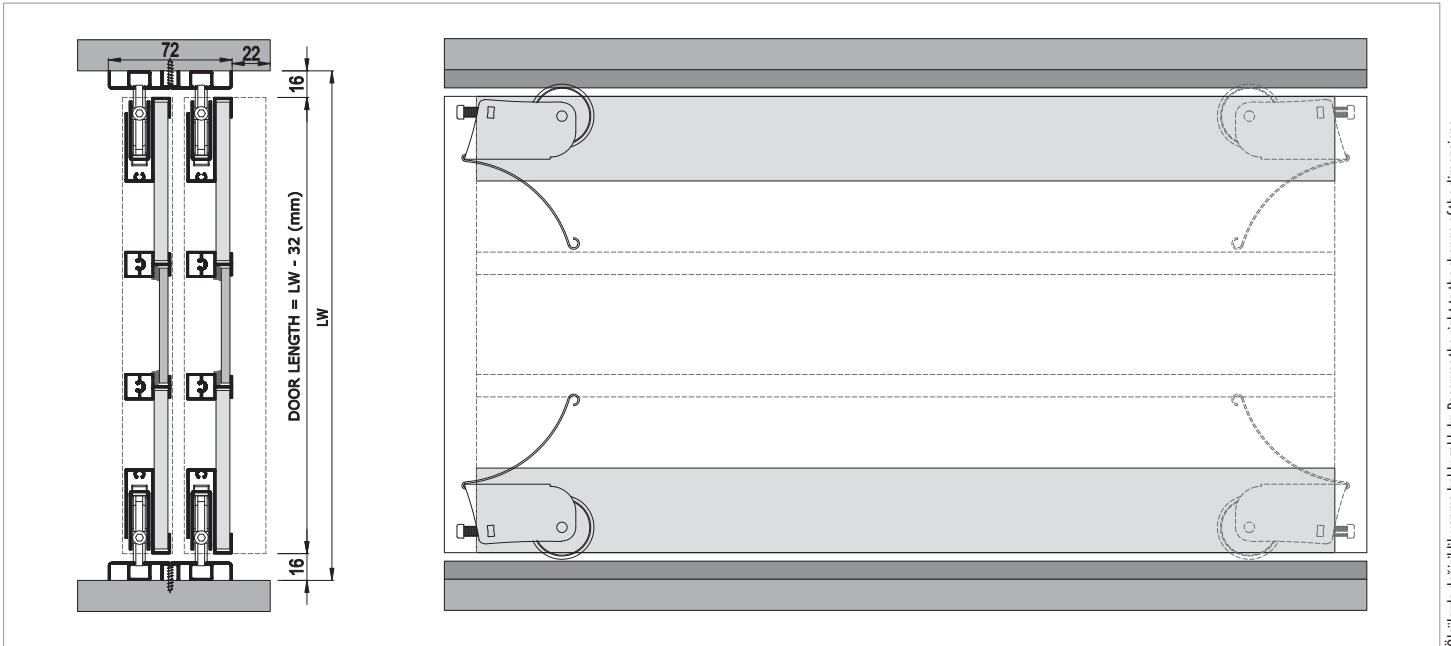

Ölçülerde değişiklik yapma hakkı saklıdır. Reserves the right to the change of the dimensions.

Kod / Code No	Açıklama / Description	Renk / Colour	Birim / Unit			Profil mt. / Profiles mt.	Bağ / Bnd.
109-0254-1200	RIGEL 4 - 50 Kg Sürme Pano Sistemi / 50 Kg Sliding Panel System	Silver	1 Takım / 1 Kit	32	1.024	- - -	-
145-1810-1640	Kapama Fitolu / Closing Wick	Gri / Grey	mt.	100	3.600	- - -	-
145-1006-1673	Kapama Fitolu / Closing Wick	Gri / Grey	mt.	100	3.600	- - -	-
145-1811-1600	Kıl Fitolu / Ec-Wf Hair Wick	Gri / Grey	mt.	300	7.200	- - -	-
150-2003-1440	Alüminyum Ray Profili / Aluminium Rail Profile	Bronz Parlak / Bronze Bright	mt.	-	-	- - 3,0	10 ad/pcs
150-2000-1440	Alüminyum Kulp Profili / Aluminium Handle Profile	Bronz Parlak / Bronze Bright	mt.	-	-	- - 3,0	6 ad/pcs
150-2001-1440	Alüminyum Alt-Üst Kayıt Profili / Aluminium Bottom-Top Profile	Bronz Parlak / Bronze Bright	mt.	-	-	- - 3,0	6 ad/pcs
150-2002-1440	Alüminyum Orta Kayıt Profili / Aluminium Horizontal Central Profile	Bronz Parlak / Bronze Bright	mt.	-	-	- - 3,0	10 ad/pcs
150-2004-1440	Alüminyum Kulp Profili / Aluminium Handle Profile	Bronz Parlak / Bronze Bright	mt.	-	-	- - 3,0	6 ad/pcs

Rigel Alüminyum Kapak Sistemi

ALUMINIUM FULL FRAME SYSTEM

Yeni Ürün
New Product

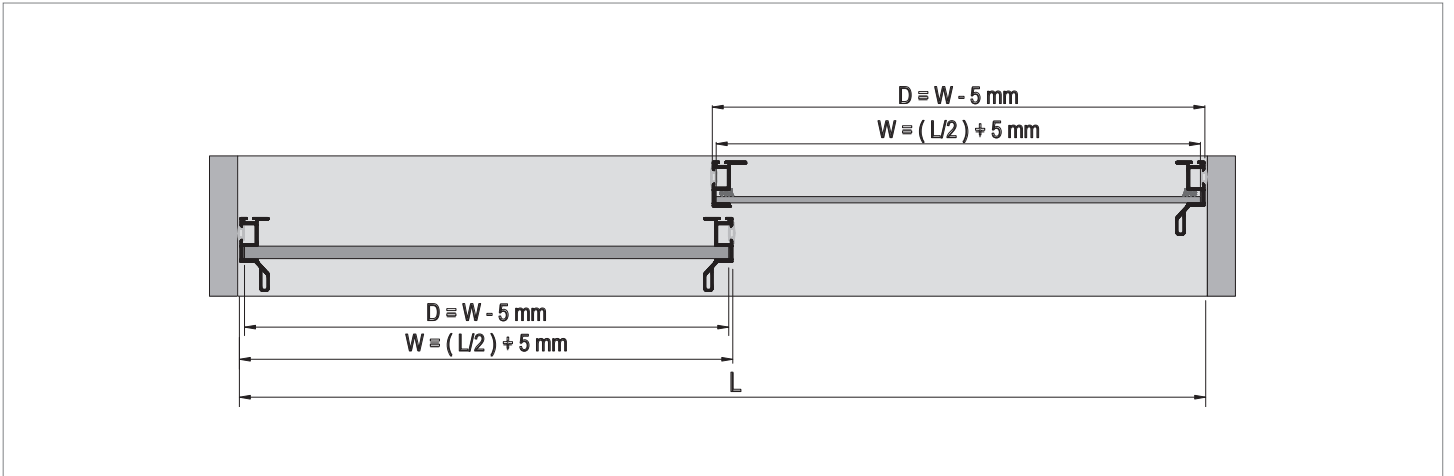
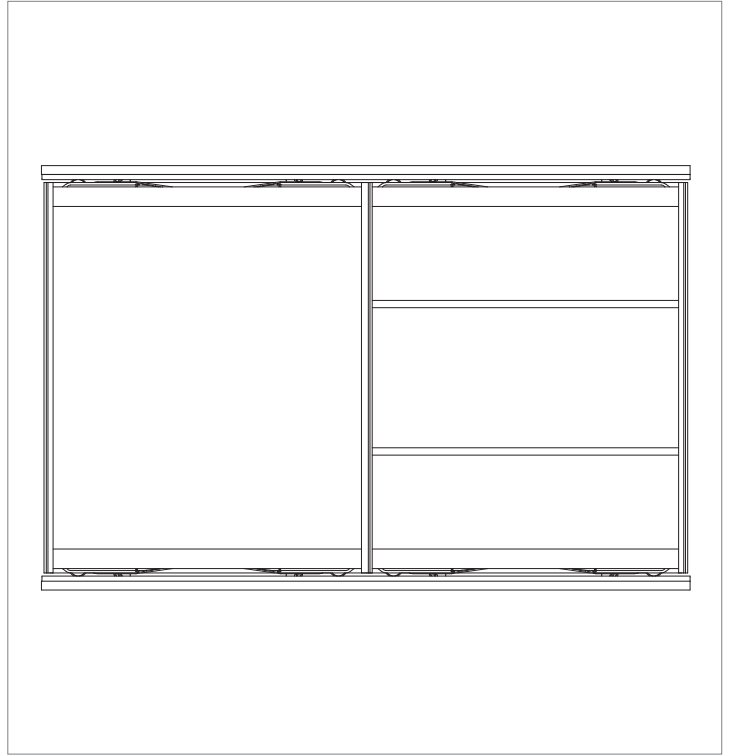
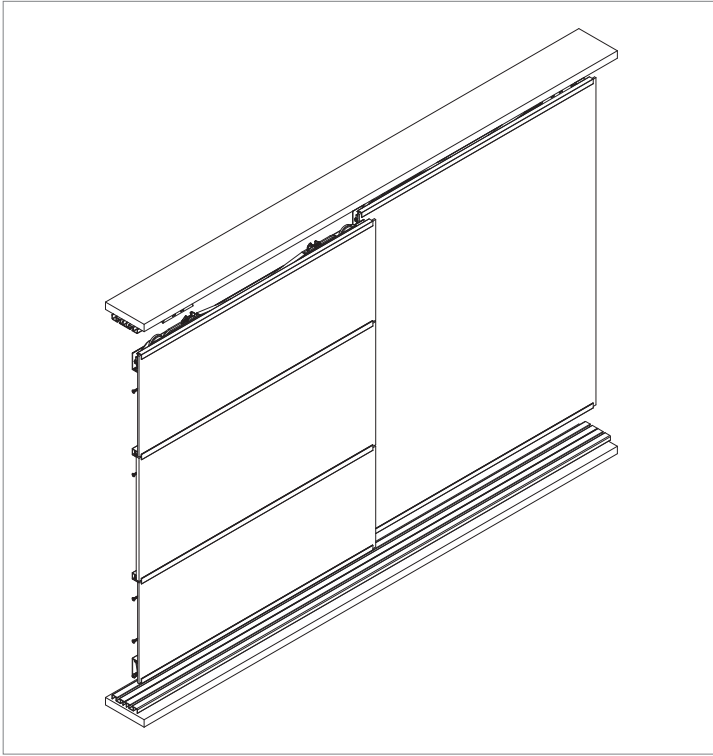
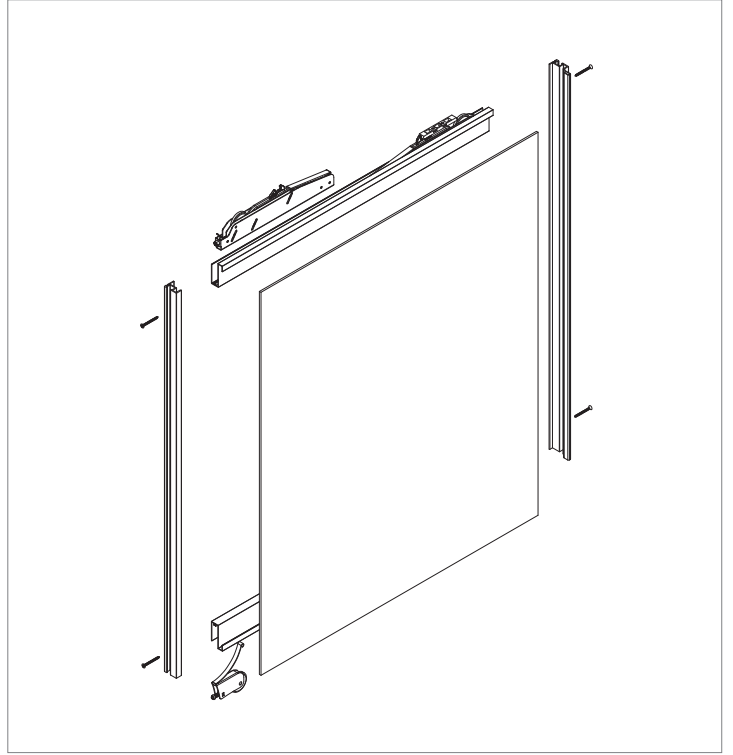
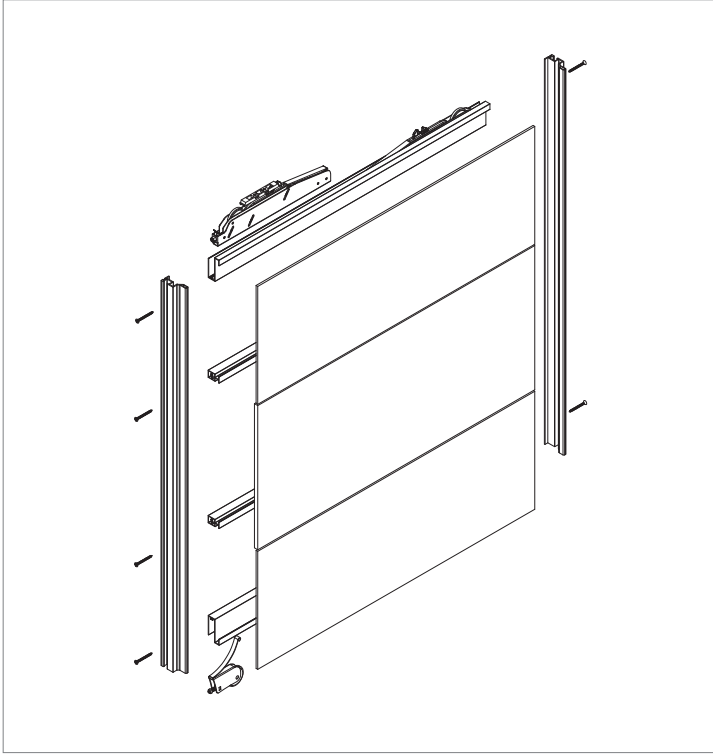

Rigel 1801

60 KG ALÜMİNYUM RAYLI PANO SİSTEMİ • SLIDING ALUMINIUM PANEL/DOOR SYSTEM

0180

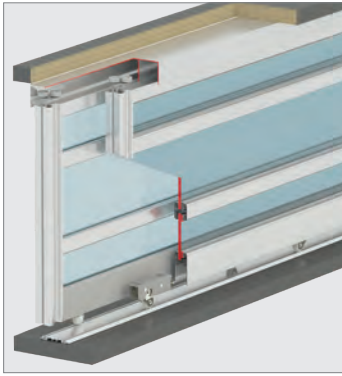

■ Yavaşlatıcı Alternatifi / Soft Closer Alternative

117-6700-1600 <<>> 117-6922-1610 <<>> 117-6921-1600 <<>>



■ 109-1801 1 Takım İçeriği / 1 Kit Includes

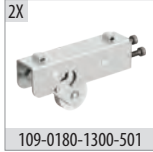
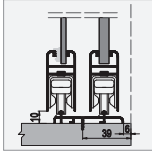

■ 109-1812 1 Takım İçeriği / 1 Kit Includes

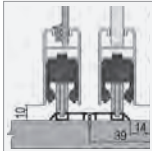

■ Alüminyum Fitilleri / Aluminium Wicks

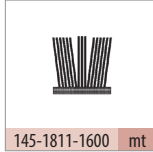

■ Ray Profilleri / Rail Profiles

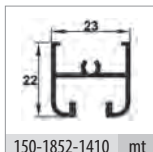
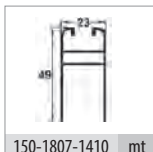
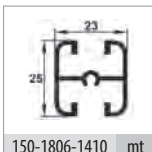
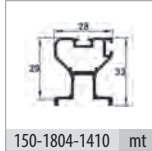
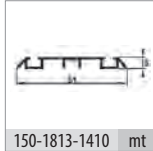
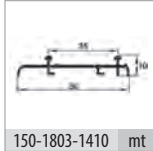

■ Teknik Detay / Technical Detail

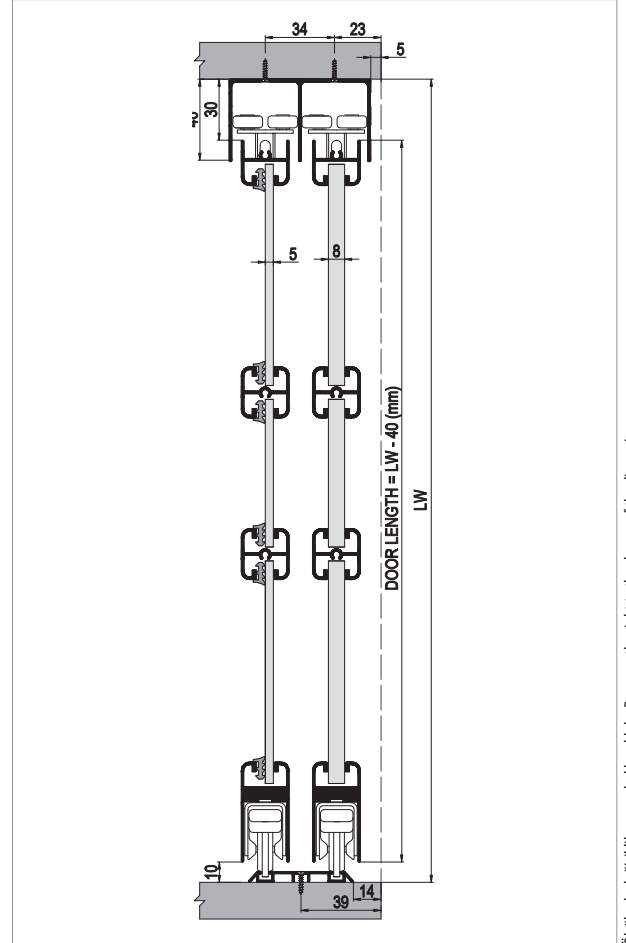

Ölçülerde değişiklik yapıma hakkı saklıdır. Reserves the right to the change of the dimensions.

Kod / Code No	Açıklama / Description	Renk / Colour	Birim / Unit			Profil mt. / Profiles mt.	Bağ / Bnd.
109-1801-1300	60 Kg. Pano Dişi Teker Mekanizması / Panel System Beta	Galvaniz / Galvanized	1 Kapak / 1 Kit	48	1.152	-	-
109-1812-1300	60 Kg. Pano Erkek Teker Mekanizması / Panel System Gama	Galvaniz / Galvanized	1 Kapak / 1 Kit	48	1.152	-	-
145-1808-1600	Kapama Fitolu / Closing Wick	Gri / Grey	mt.	100	3.600	-	-
145-1810-1640	Cam Fitolu / Glass Wick	Şeffaf / Transparan	mt.	100	3.600	-	-
145-1811-1600	Kıl Fitolu / Ec-Wf Hair Wick	Gri / Grey	mt.	300	7.200	-	-
150-1802-1410	Alüminyum Üst Ray Profili / Aluminium Top Rail Profile	Eloksal / Mat Anodized	mt.	-	-	-	6,0
150-1803-1410	Alüminyum Alt Ray Profili / Aluminium Bottom Rail Profile	Eloksal / Mat Anodized	mt.	-	-	-	6,0
150-1813-1410	Alüminyum Alt Ray Profili / Aluminium Bottom Rail Profile	Eloksal / Mat Anodized	mt.	-	-	-	6,0
150-1804-1410	Alüminyum Kulp Profili / Aluminium Handle Profile	Eloksal / Mat Anodized	mt.	-	-	-	6,0
150-1806-1410	Alüminyum Orta Kayıt Profili / Aluminium Horizontal Central Profile	Eloksal / Mat Anodized	mt.	-	-	-	6,0
150-1807-1410	Alüminyum Kapama Profili / Aluminium Closure Profile	Eloksal / Mat Anodized	mt.	-	-	-	6,0
150-1852-1410	Alüminyum Üst Kayıt Profili / Aluminium Top Entry Profile	Eloksal / Mat Anodized	mt.	-	-	-	6,0