

DoorSync[®] Wood

Ahşap Senkronize Sürme Kapı Serisi

Wooden Funicular Sliding Door Series

121

Group 121

DoorSync[®] Wood

Ahşap Senkronize Sürme Kapı Serisi

Wooden Funicular Sliding Door Series



Bu serideki tüm ürünleri incelemek için QR kodu okutabilirsiniz.

You can search the QR code to see all the products in these series.

DoorSync Wood

HALATLI SÜRGÜ KAPI SİSTEMİ • FUNICULAR SLIDING DOOR SYSTEM

Group 121

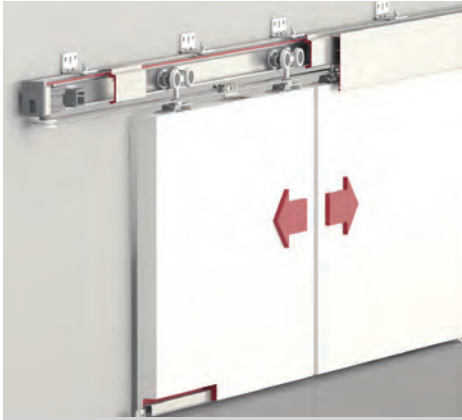

DoorSync **9800**

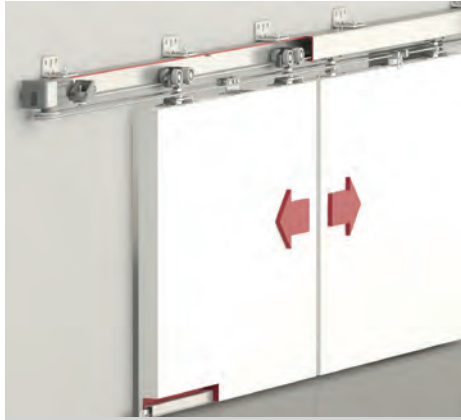

DoorSync **9810**

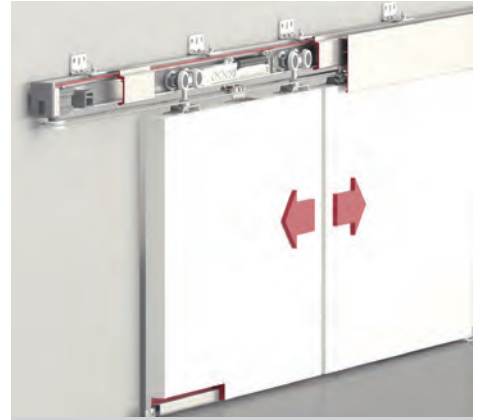

DoorSync **9801**

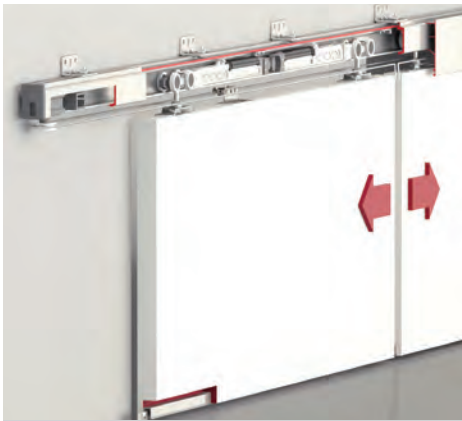

DoorSync **9820**

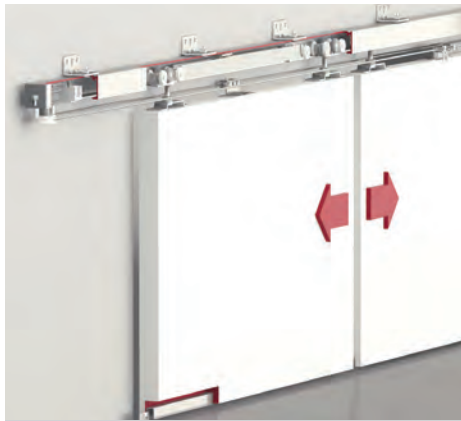

DoorSync **9830**

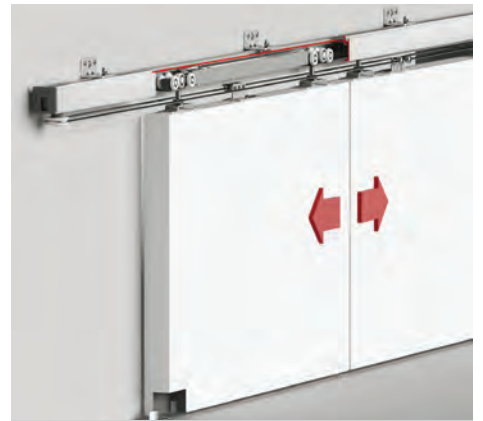

DoorSync **9840**

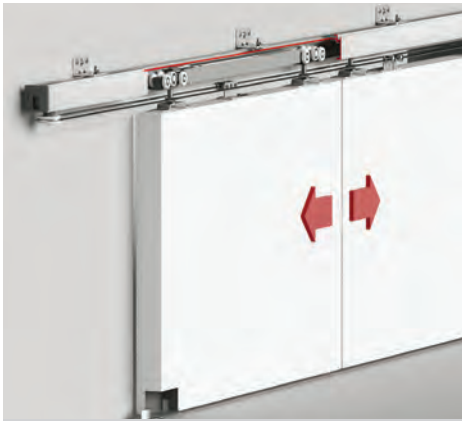

DoorSync **9850**

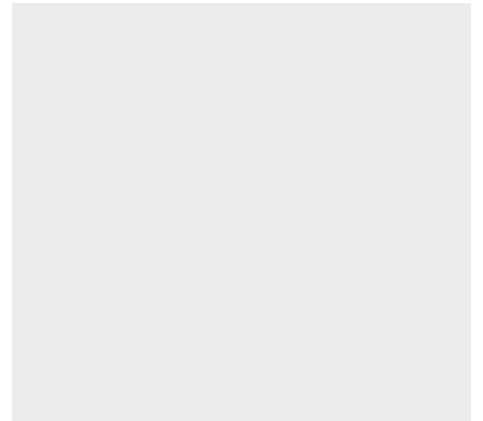
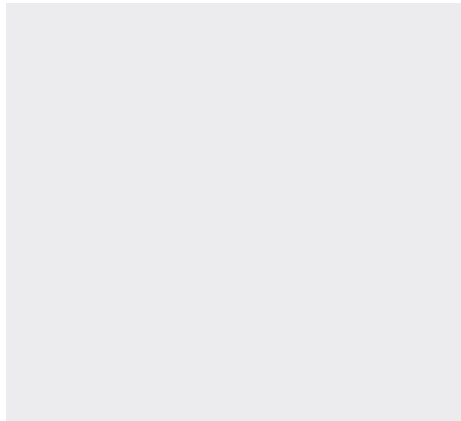

DoorSync 9800

120 KG HALATLI SÜRGÜ KAPI SİSTEMİ • FUNICULAR SLIDING DOOR SYSTEM



121-9800 1 Set İçeriği / 1 Set Includes

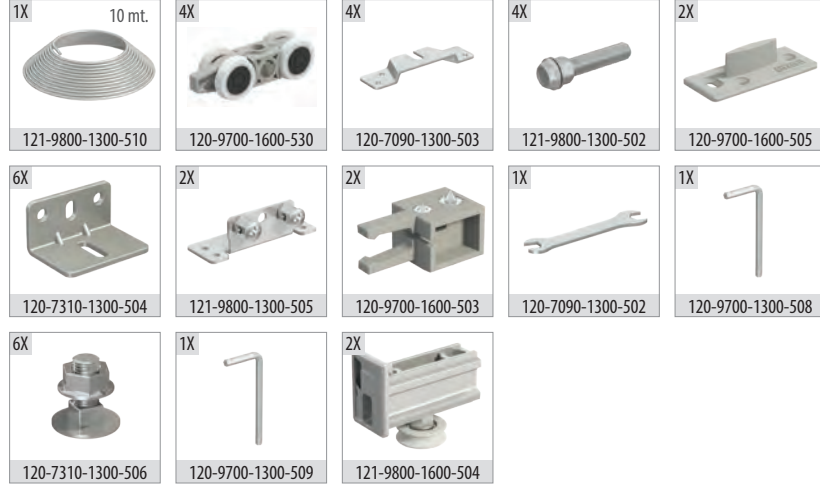

Ray Profilleri / Rail Profiles

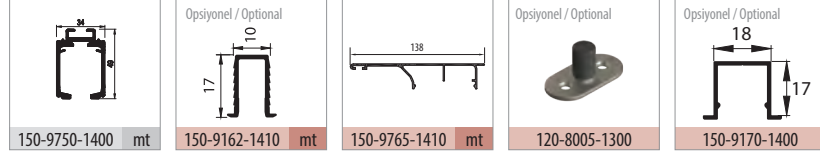

Uygulama / Application



Teknik Detay / Technical Detail

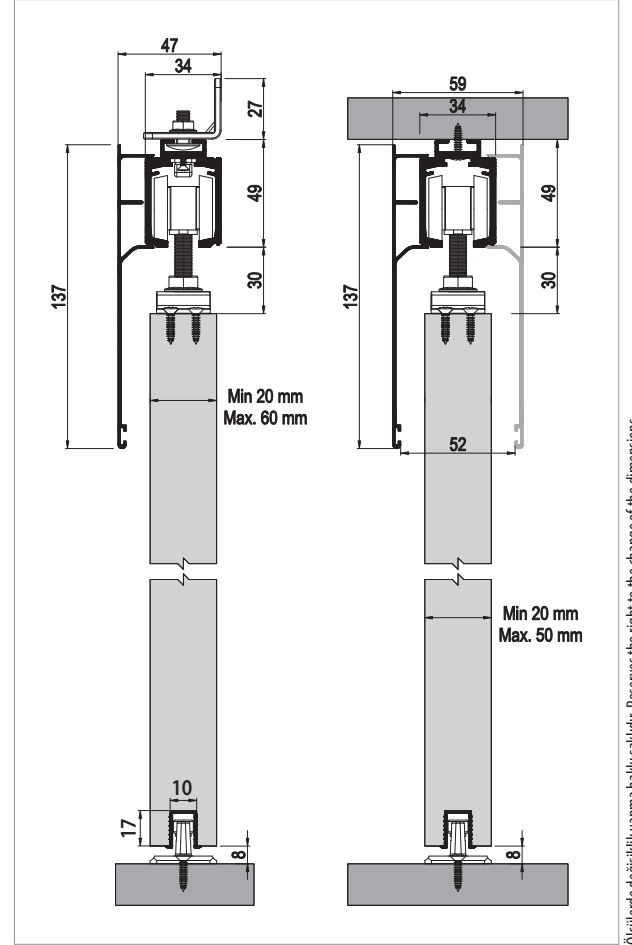

Ölçülerde değişiklik yapma hakkı saklıdır. Reserves the right to the change of the dimensions.

| Kod / Code No | Açıklama / Description | Renk / Colour | Birim / Unit | | | Profil mt. / Profiles mt. | Bağ / Bnd. |
|---------------|--|------------------------|----------------|----|-----|---------------------------|------------|
| 121-9800-1600 | 120 Kg Senkronize Sürgü Kapı Sistemi / Funicular Sliding Door System | Gri / Grey | 2 Kapı / 1 Set | 12 | 216 | - | - |
| 150-9750-1400 | Alüminyum Üst Ray Profili / Aluminium Top Rail Profile | Pres / Uncoated | mt. | - | - | 3,0 | 4,0 |
| 150-9162-1410 | Alüminyum Alt Klavuz Profili / Aluminium Bottom Slider Profile | Eloksal / Mat Anodized | mt. | - | - | 3,0 | - |
| 150-9765-1410 | Alüminyum Alın Kapama / Aluminium Cover Front | Eloksal / Mat Anodized | mt. | - | - | 3,0 | 4,0 |

DoorSync 9810

80 KG HALATLI SÜRGÜ KAPI SİSTEMİ • FUNICULAR SLIDING DOOR SYSTEM

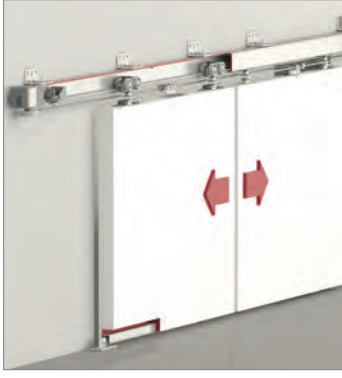

121-9810 1 Set İçeriği / 1 Set Includes



Ray Profilleri / Rail Profiles

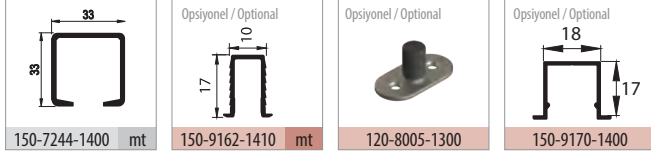

Uygulama / Application



Teknik Detay / Technical Detail

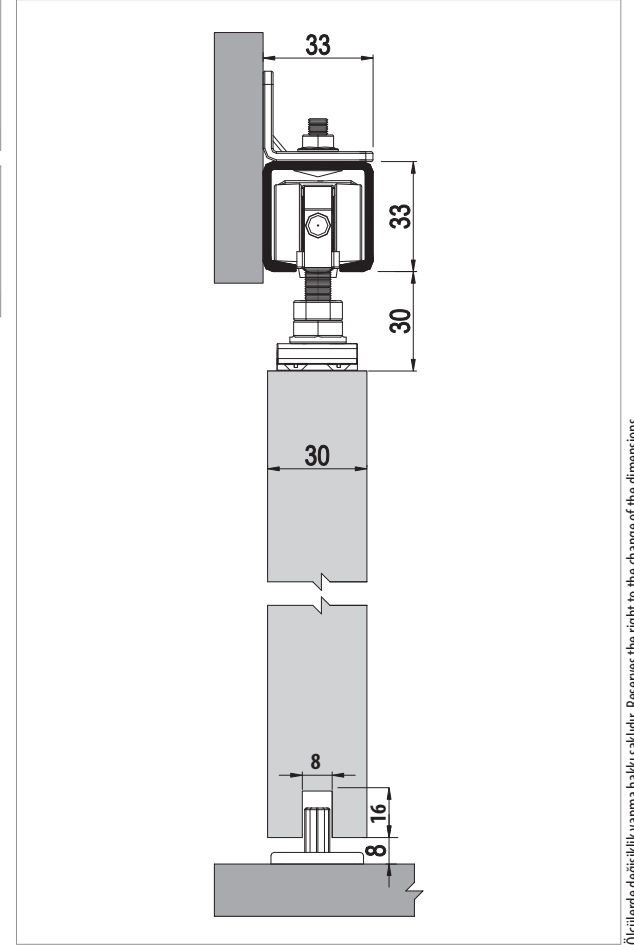

Ölçülerde değişiklik yapma hakkı saklıdır. Reserves the right to the change of the dimensions.

| Kod / Code No | Açıklama / Description | Renk / Colour | Birim / Unit | | | Profil mt. / Profiles mt. | | | Bağ / Bnd. |
|---------------|---|------------------------|----------------|----|-----|---------------------------|-----|-----|------------|
| 121-9810-1600 | 80 Kg Senkronize Sürgü Kapa Sistemi / Funicular Sliding Door System | Gri / Grey | 2 Kapa / 1 Set | 12 | 216 | - | - | - | - |
| 150-7244-1400 | Alüminyum Üst Ray Profili / Aluminium Top Rail Profile | Pres / Uncoated | mt. | - | - | 3,0 | 4,0 | 6,0 | 6 ad/pcs |
| 150-9162-1410 | Alüminyum Alt Klavuz Profili / Aluminium Bottom Slider Profile | Eloksal / Mat Anodized | mt. | - | - | - | - | 3,0 | 20 ad/pcs |

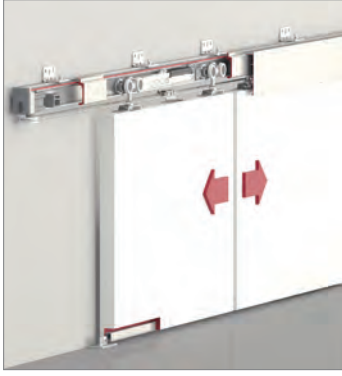

Bilgi / Information

- Minimum kapı genişliği 500 mm olmalıdır.
- Min. Door width 500 mm

Yavaşlatıcı Alternatifi / Soft Closer Alternative

- Sistem üzerinde tek yöne yavaşlatıcı mevcuttur.
- The system has one way soft closing.



121-9801 1 Set İçeriği / 1 Set Includes



Ray Profilleri / Rail Profiles

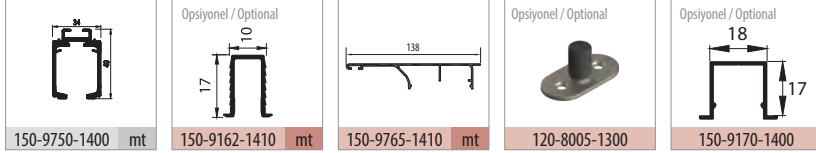

Uygulama / Application



Teknik Detay / Technical Detail

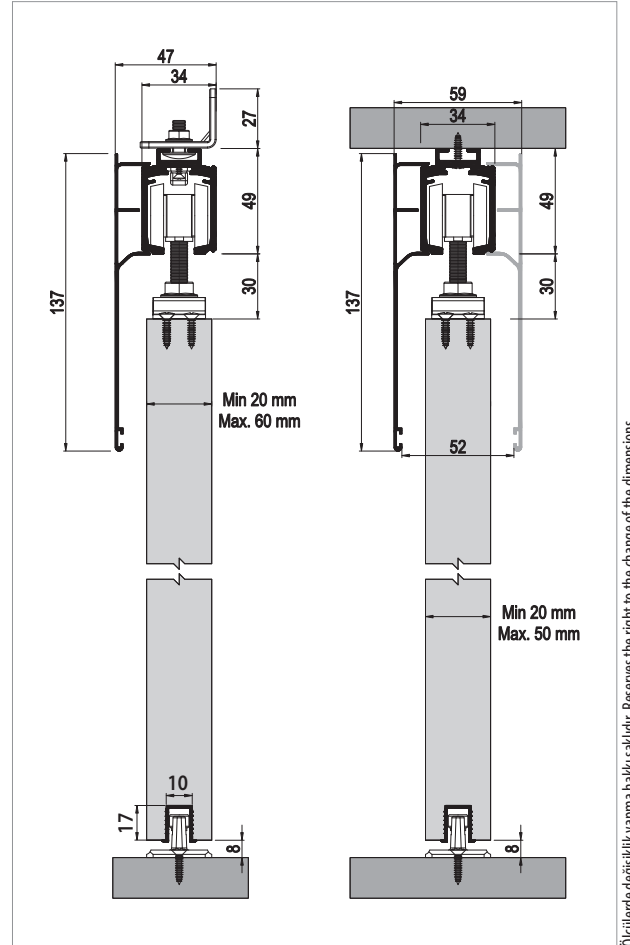

Ölçülerde değişiklik yapma hakkı saklıdır. Reserves the right to the change of the dimensions.

| Kod / Code No | Açıklama / Description | Renk / Colour | Birim / Unit | | | Profil mt. / Profiles mt. | Bağ / Bnd. |
|---------------|---|------------------------|----------------|----|-----|---------------------------|------------|
| 121-9801-1600 | 120 Kg Yavaşlatıcılı Halatlı Sürgü Kapı Sistemi / Funicular Sliding Door Has Soft Closing | Gri / Grey | 2 Kapı / 1 Set | 12 | 216 | - | - |
| 150-9750-1400 | Alüminyum Üst Ray Profili / Aluminium Top Rail Profile | Pres / Uncoated | mt. | - | - | 3,0 | 4,0 |
| 150-9162-1410 | Alüminyum Alt Klavuz Profili / Aluminium Bottom Slider Profile | Eloksal / Mat Anodized | mt. | - | - | 3,0 | - |
| 150-9765-1410 | Alüminyum Alın Kapama / Aluminium Cover Front | Eloksal / Mat Anodized | mt. | - | - | 3,0 | 4,0 |

DoorSync 9820

120 KG ÇİFT YÖNE YAVAŞLATICILI HALATLI SÜRGÜ KAPI SİSTEMİ • FUNICULAR SLIDING DOOR SYSTEM - HAS SOFT CLOSING

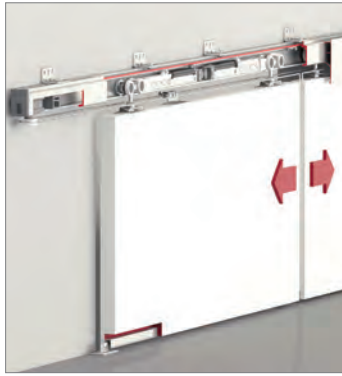

Bilgi / Information

- Minimum kapı genişliği 830 mm olmalıdır.
- Min. Door width 830 mm

Yavaşlatıcı Alternatifi / Soft Closer Alternative

- Sistem üzerinde çift yöne yavaşlatıcı mevcuttur.
- The system has two way soft closing.



121-9820 1 Set İçeriği / 1 Set Includes



Ray Profilleri / Rail Profiles

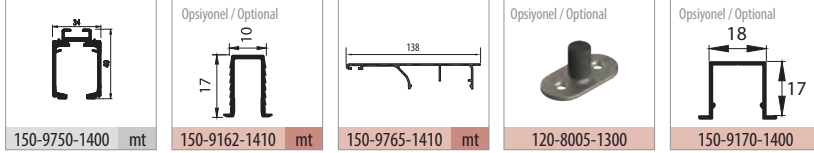

Uygulama / Application



Teknik Detay / Technical Detail

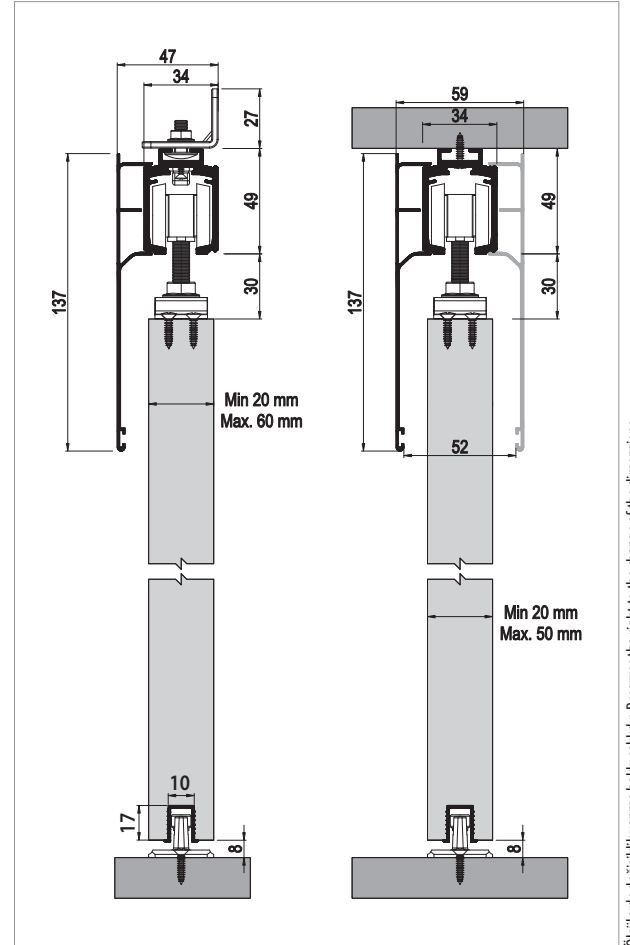

Ölçülerde değişiklik yapma hakkı saklıdır. Reserves the right to the change of the dimensions.

| Kod / Code No | Açıklama / Description | Renk / Colour | Birim / Unit | | | Profil mt. / Profiles mt. | Bağ / Bnd. |
|---------------|---|------------------------|----------------|----|-----|---------------------------|------------|
| 121-9820-1600 | 120 Kg Yavaşlatıcılı Halatlı Sürgü Kapı Sistemi / Funicular Sliding Door Has Soft Closing | Gri / Grey | 2 Kapı / 1 Set | 12 | 216 | - | - |
| 150-9750-1400 | Alüminyum Üst Ray Profili / Aluminium Top Rail Profile | Pres / Uncoated | mt. | - | - | 3,0 | 4,0 |
| 150-9162-1410 | Alüminyum Alt Klavuz Profili / Aluminium Bottom Slider Profile | Eloksal / Mat Anodized | mt. | - | - | 3,0 | - |
| 150-9765-1410 | Alüminyum Alın Kapama / Aluminium Cover Front | Eloksal / Mat Anodized | mt. | - | - | 3,0 | 4,0 |

DoorSync 9830

60 KG ÇİFT YÖNE YAVAŞLATICILI HALATLI SÜRGÜ KAPI SİSTEMİ • FUNICULAR SLIDING DOOR SYSTEM - HAS SOFT CLOSING



Bilgi / Information

- Minimum kapı genişliği 650 mm olmalıdır.
- Min. Door width 650 mm

Yavaşlatıcı Alternatifi / Soft Closer Alternative

- Sistem üzerinde çift yöne yavaşlatıcı mevcuttur.
- The system has two way soft closing.



121-9830 1 Set İçeriği / 1 Set Includes



Ray Profilleri / Rail Profiles

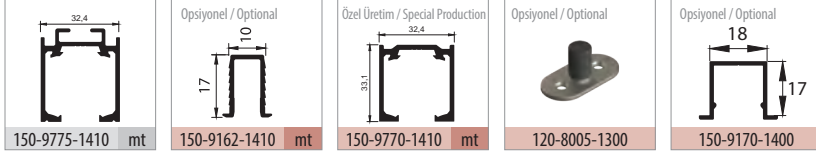

Uygulama / Application



Teknik Detay / Technical Detail

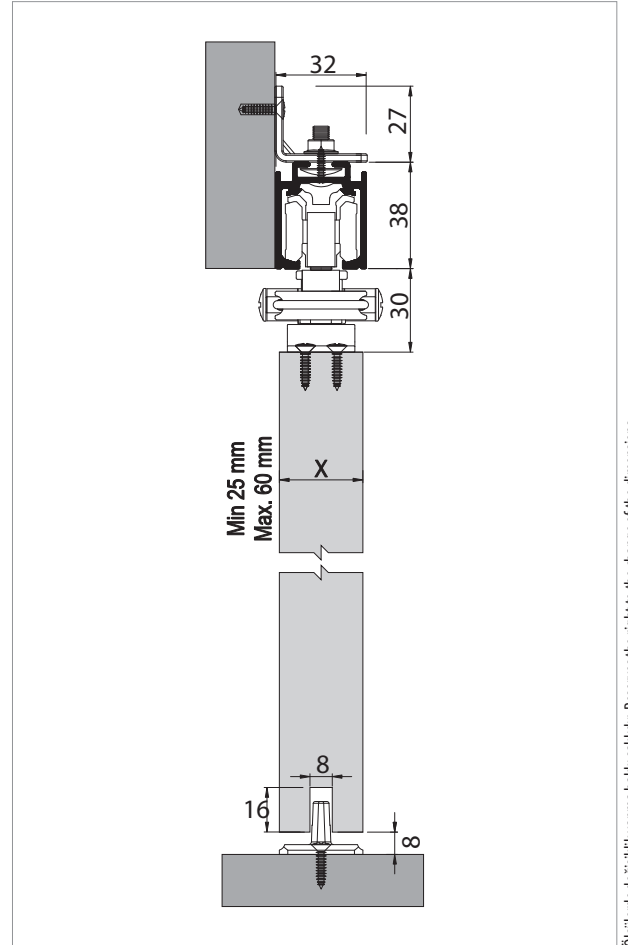

Ölçülerde değişiklik yapma hakkı saklıdır. Reserves the right to the change of the dimensions.

| Kod / Code No | Açıklama / Description | Renk / Colour | Birim / Unit | | | Profil mt. / Profiles mt. | | | Bağ / Bnd. |
|---------------|--|------------------------|----------------|---|-----|---------------------------|-----|-----|------------|
| 121-9830-1410 | 60 Kg Yavaşlatıcılı Halatlı Sürgü Kapı Sistemi / Funicular Sliding Door Has Soft Closing | Gri / Grey | 2 Kapı / 1 Set | 4 | 160 | - | - | - | - |
| 150-9775-1410 | Alüminyum Üst Ray Profili / Aluminium Top Rail Profile | Eloksal / Mat Anodized | mt. | - | - | 3,0 | 4,0 | 6,0 | 6 ad/pcs |
| 150-9162-1410 | Alüminyum Alt Klavuz Profili / Aluminium Bottom Slider Profile | Eloksal / Mat Anodized | mt. | - | - | 3,0 | 4,0 | - | 20 ad/pcs |

DoorSync 9840

40 KG ÇİFT YÖNE YAVAŞLATICILI HALATLI SÜRGÜ KAPI SİSTEMİ - FUNICULAR SLIDING DOOR SYSTEM - HAS SOFT CLOSING

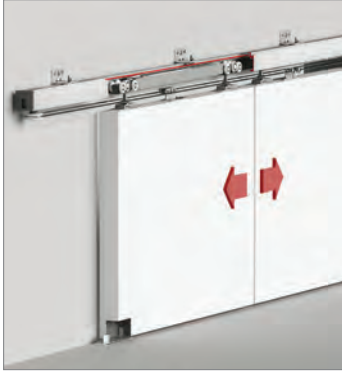

Bilgi / Information

- Minimum kapı genişliği 450 mm olmalıdır.
- Min. Door width 450 mm

Yavaşlatıcı Alternatifi / Soft Closer Alternative

- Sistem üzerinde çift yöne yavaşlatıcı mevcuttur.
- The system has two way soft closing.



121-9840 1 Set İçeriği / 1 Set Includes



Ray Profilleri / Rail Profiles

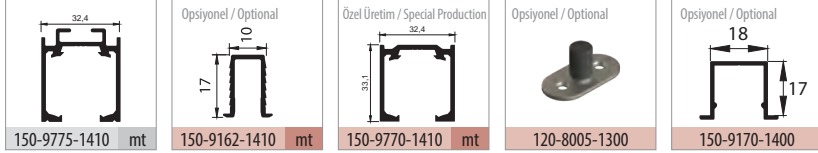

Uygulama / Application



Teknik Detay / Technical Detail

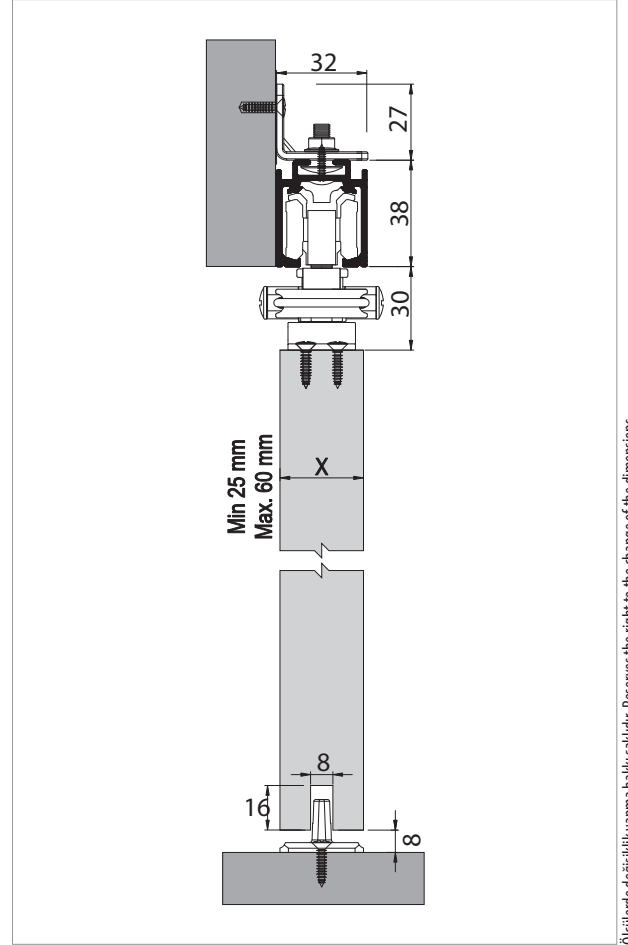

Ölçülerde değişiklik yapma hakkı saklıdır. Reserves the right to the change of the dimensions.

| Kod / Code No | Açıklama / Description | Renk / Colour | Birim / Unit | | | Profil mt. / Profiles mt. | Bağ / Bnd. | | |
|---------------|--|------------------------|----------------|----|-----|---------------------------|------------|-----|-----------|
| 121-9840-1410 | 40 Kg Yavaşlatıcılı Halatlı Sürgü Kapı Sistemi / Funicular Sliding Door Has Soft Closing | Gri / Grey | 2 Kapı / 1 Set | 12 | 216 | - | - | - | |
| 150-9775-1410 | Alüminyum Üst Ray Profili / Aluminium Top Rail Profile | Eloksal / Mat Anodized | mt. | - | - | 3,0 | - | 6,0 | 6 ad/pcs |
| 150-9162-1410 | Alüminyum Alt Klavuz Profili / Aluminium Bottom Slider Profile | Eloksal / Mat Anodized | mt. | - | - | 3,0 | - | - | 20 ad/pcs |

DoorSync 9850

60 KG ÇİFT YÖNE YAVAŞLATICILI HALATLI SÜRGÜ KAPI SİSTEMİ • FUNICULAR SLIDING DOOR SYSTEM - HAS SOFT CLOSING

Özel Üretim
Special Production

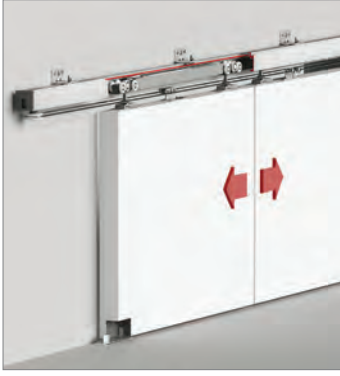

Bilgi / Information

- Minimum kapı genişliği 610 mm olmalıdır.
- Min. Door width 610 mm

Yavaşlatıcı Alternatifi / Soft Closer Alternative

- Sistem üzerinde çift yöne yavaşlatıcı mevcuttur.
- The system has two way soft closing.



121-9850 1 Set İçeriği / 1 Set Includes

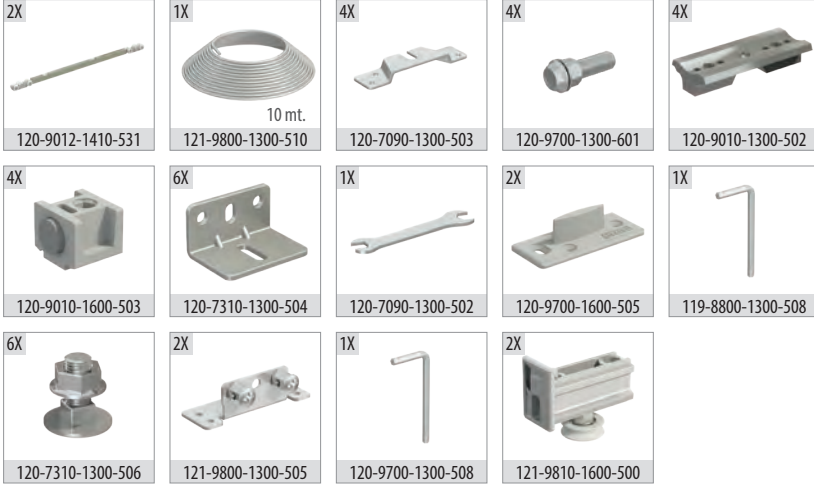

Ray Profilleri / Rail Profiles

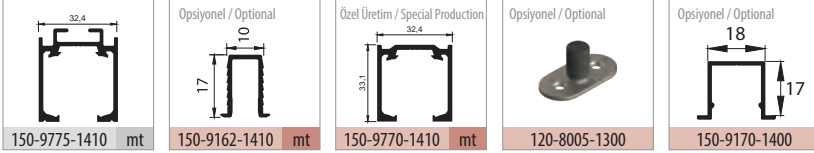

Uygulama / Application



Teknik Detay / Technical Detail

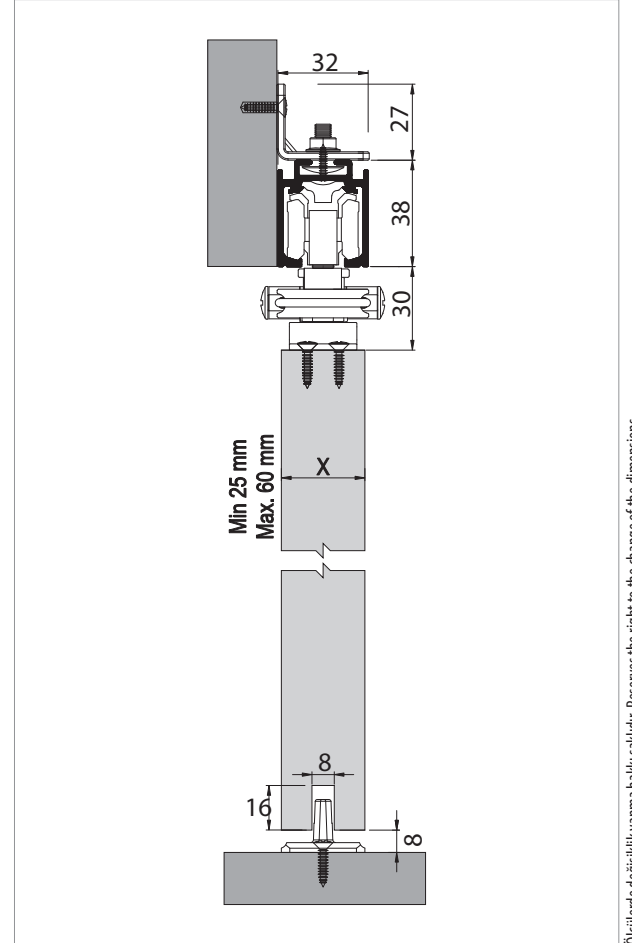

Ölçülerde değişiklik yapma hakkı saklıdır. Reserves the right to the change of the dimensions.

| Kod / Code No | Açıklama / Description | Renk / Colour | Birim / Unit | | | Profil mt. / Profiles mt. | Bağ / Bnd. |
|---------------|--|------------------------|----------------|---|-----|---------------------------|------------|
| 121-9850-1410 | 40 Kg Yavaşlatıcı Halatlı Sürgü Kapı Sistemi / Funicular Sliding Door Has Soft Closing | Gri / Grey | 2 Kapı / 1 Set | 4 | 160 | - | - |
| 150-9775-1410 | Alüminyum Üst Ray Profili / Aluminium Top Rail Profile | Eloksal / Mat Anodized | mt. | - | - | 3,0 | 6,0 |
| 150-9162-1410 | Alüminyum Alt Klavuz Profili / Aluminium Bottom Slider Profile | Eloksal / Mat Anodized | mt. | - | - | 3,0 | 20 ad/pcs |



DoorSync 9820

ÇİFT YÖNE YAVAŞLATICILI HALATLI SÜRGÜ KAPI SİSTEMİ • FUNICULAR SLIDING DOOR SYSTEM - HAS SOFT CLOSING

albaturas.com