



# MasterFold®

# MidFold®

## Ahşap Katlanır Sürme Kapı Serisi

Wooden Foldable Sliding Door Series



Bu serideki tüm ürünleri incelemek için QR kodu okutabilirsiniz.

You can search the QR code to see all the products in these series.

# MasterFold & MidFold

AHŞAP KATLANIR SÜRME KAPI SERİSİ • WOODEN FOLDABLE SLIDING DOOR SERIES

Group **122**



Domino **90**



Domino **180**



MasterFold **42**



MasterFold **44**



MasterFold **60**

9060



MidFold **60**

9062



MasterFold **160**

9300



MidFold **160**

9500



**122-1050-1800**



**122-1052-1820**

# Domino 90

90 DERECE AÇILIR KATLANIR KAPI DONANIMI • 90 DEGREE BI-FOLDING DOOR HARDWARE

Yeni Ürün  
New Product

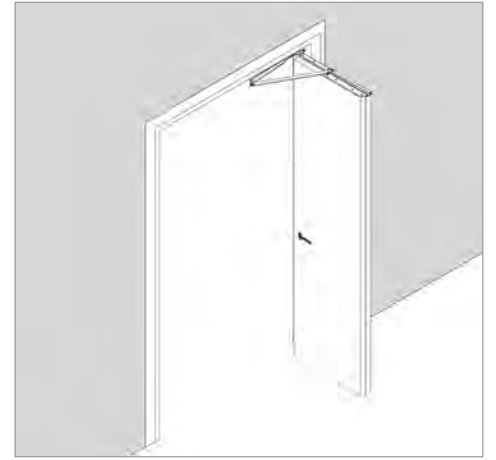
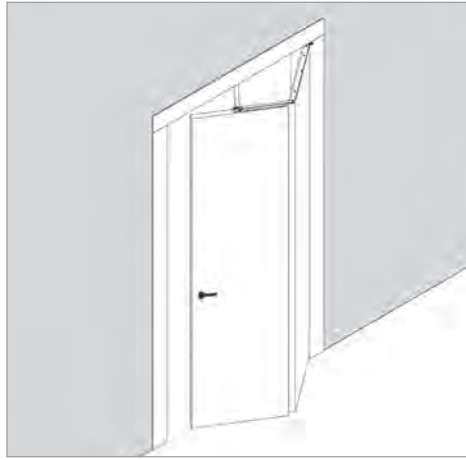
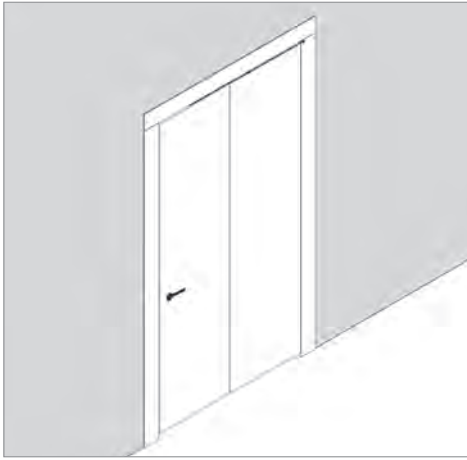

Kod / Code No	Açıklama / Description	Boy / Size	Birim / Unit
122-0090-1820-0600	Domino 90 - Sağ Kapı / Right Door	600 mm	1 Tk. / 1 Set
122-0090-1820-0700	Domino 90 - Sağ Kapı / Right Door	700 mm	1 Tk. / 1 Set
122-0090-1820-0800	Domino 90 - Sağ Kapı / Right Door	800 mm	1 Tk. / 1 Set
122-0090-1820-0900	Domino 90 - Sağ Kapı / Right Door	900 mm	1 Tk. / 1 Set
122-0090-1820-1000	Domino 90 - Sağ Kapı / Right Door	1.000 mm	1 Tk. / 1 Set
122-0095-1820-0600	Domino 90 - Sol Kapı / Left Door	600 mm	1 Tk. / 1 Set
122-0095-1820-0700	Domino 90 - Sol Kapı / Left Door	700 mm	1 Tk. / 1 Set
122-0095-1820-0800	Domino 90 - Sol Kapı / Left Door	800 mm	1 Tk. / 1 Set
122-0095-1820-0900	Domino 90 - Sol Kapı / Left Door	900 mm	1 Tk. / 1 Set
122-0095-1820-1000	Domino 90 - Sol Kapı / Left Door	1.000 mm	1 Tk. / 1 Set

## Bilgi / Information

- 90 derece katlanıp park edilebilir kapı makas sistemidir.
- Dar alan bölgelerde kapının açıldığı esnada yerden tasarruf edilmesini sağlar.
- Ahşap kapılar için tasarlanmıştır.
- 36-44 mm ahşap kapılarda kullanıma uygundur.
- Hızlı montaj kiti 40 mm kapılar için kullanılabilir.
- Sistemin toplam taşıma kapasitesi 45 kg'dır.
- Kolay ve ahşap kapı üzerinde herhangi bir freze/cnc işlem gerektirmeden montaj edilebilmesi için montaj yatak kiti kullanılarak da uygulanabilir özelliğe sahiptir.
- Montaj yatak kiti istenilen renkte boyanarak kapı ile bir bütünlük sağlanabilir.
- Ahşap üzerine işlem yapmadan montaj edilebilir.
- Mekanizma gövdesi paslanmaz malzemeden imal edilmiştir.
- Islak mekanlarda kullanılabilir.
- Farklı kanat açıklıkları için 5 tip ölçüde imal edilmiştir.
- Kapının park ettiği alanın görüleceği içten bakış yönüne göre sağ ve sol mekanizma olarak 2 tip üretimi mevcuttur.
- Estetik görünüm ve sağlıklı çalışma sistemine sahiptir.
- İç mekan kapılarda kullanıma uygundur.
- Kapı üzerine istenilen açma kolu ve/veya tutamak tek yönlü montaj edilebilmektedir.

- It's door scissor system that can be fold and parked 90 degrees.
- It's saves space when opening the door in narrow areas.
- Designed for wooden doors.
- It's available for use on 36-44 mm wooden doors.
- The quick assembly kit can be used for 40 mm
- Total carrying capacity of the system is 45 kg.
- Can also be apply by using the mounting bed kit for easy fixing on the wooden door without any milling cutter /cnc operation.
- The assembly bed kit can be paint in the required color and an integrity with the door can be achieved.
- Can be mounted on wood without processing.
- Mechanism body is made of stainless material.
- Can be used in wet places.
- For the gaps of wing , it's produced in 5 different types of sizes
- There are 2 types of production; as right and left mechanism according to the inside view direction from which the area where the door is parked will be seen.
- It has aesthetic appearance and in well working system
- Available for use on interior doors.
- The required door handle and/or handle can be fixing on the door in one direction.

# Domino 180

180 DERECE AÇILIR KATLANIR KAPI DONANIMI • 180 DEGREE BI-FOLDING DOOR HARDWARE

Yeni Ürün  
New Product

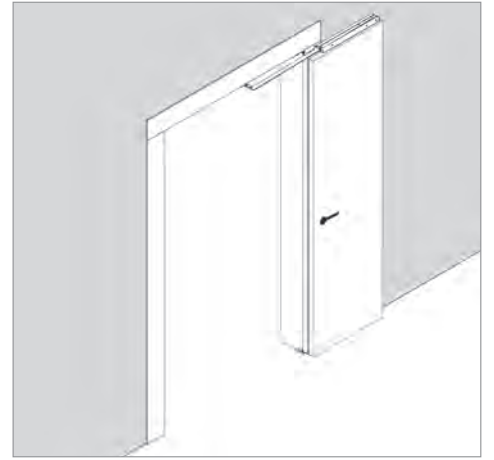
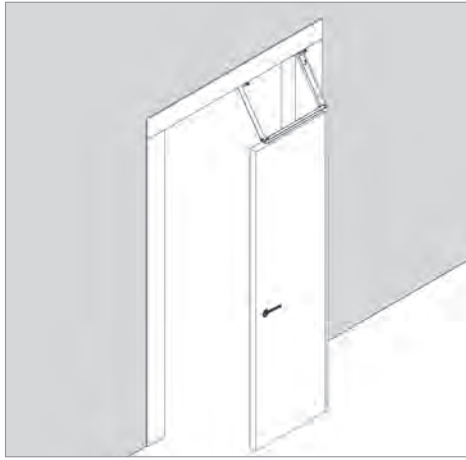
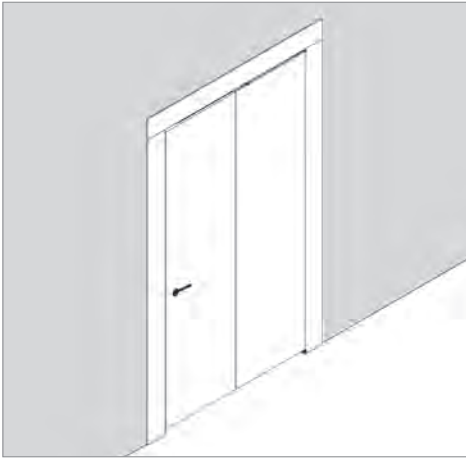

Kod / Code No	Açıklama / Description	Boy / Size	Birim / Unit
122-0180-1820-0600	Domino 180 - Sağ Kapı / Right Door	600 mm	1 Tk. / 1 Set
122-0180-1820-0700	Domino 180 - Sağ Kapı / Right Door	700 mm	1 Tk. / 1 Set
122-0180-1820-0800	Domino 180 - Sağ Kapı / Right Door	800 mm	1 Tk. / 1 Set
122-0180-1820-0900	Domino 180 - Sağ Kapı / Right Door	900 mm	1 Tk. / 1 Set
122-0180-1820-1000	Domino 180 - Sağ Kapı / Right Door	1.000 mm	1 Tk. / 1 Set
122-0185-1820-0600	Domino 180 - Sol Kapı / Left Door	600 mm	1 Tk. / 1 Set
122-0185-1820-0700	Domino 180 - Sol Kapı / Left Door	700 mm	1 Tk. / 1 Set
122-0185-1820-0800	Domino 180 - Sol Kapı / Left Door	800 mm	1 Tk. / 1 Set
122-0185-1820-0900	Domino 180 - Sol Kapı / Left Door	900 mm	1 Tk. / 1 Set
122-0185-1820-1000	Domino 180 - Sol Kapı / Left Door	1.000 mm	1 Tk. / 1 Set

## Bilgi / Information

- 180 derece katlanıp park edebilen kapı makas sistemidir.
- Dar alan bölgelerde kapının açıldığı esnada yerden tasarruf edilmesini sağlar.
- Kapı park yönünde, kapı net açıklığının yarısı kadar bir mesafede açılarak net geçiş açıklığının tamamını kullanmanızı sağlar.
- Ahşap kapılar için tasarlanmıştır.
- 36-44 mm ahşap kapılarda kullanıma uygundur.
- Hızlı montaj kiti 40 mm kapılar için kullanılabilir.
- Sistemin toplam taşıma kapasitesi 50 kg dir.
- Gerekli durumlarda gizli menteşe kullanımı ile 3 kanat tek yönde kullanıma uygundur.
- Kolay ve ahşap kapı üzerinde herhangi bir freze/cnc işlem gerektirmeden montaj edilebilmesi için montaj yatak kiti kullanılarak da uygulanabilir özelliğe sahiptir.
- Montaj yatak kiti istenilen renkte boyanarak kapı ile bir bütünlük sağlanabilir.
- Ahşap üzerine işlem yapmadan montaj edilebilir.
- Mekanizma gövdesi paslanmaz malzemeden imal edilmiştir.
- Islak mekanlarda kullanılabilir.
- Farklı kanat açıklıkları için 5 tip ölçüde imal edilmiştir.
- Kapının park ettiği alanın görüleceği içten bakış yönüne göre sağ ve sol mekanizma olarak 2 tip üretimi mevcuttur.
- Estetik görünüm ve sağlıklı çalışma sistemine sahiptir.
- İç mekan kapılarda kullanıma uygundur.
- Kapı üzerine istenilen açma kolu ve/veya tutamak tek yönlü montaj edilebilmektedir.

- It's Door Scissor System that can be fold and parked 180 degrees.
- It's saves space when opening the door in narrow areas.
- The doors in parking direction, at a distance of half the door clear opening, allowing to use the entire clear passage opening.
- Designed for wooden doors.
- It's available for use on 36-44 mm wooden doors.
- The quick assembly kit can be used for 40 mm doors.
- Total carrying capacity of the system is 50 kg.
- 3 doors are suitable for use in one direction with the use of hidden hinges when its necessary.
- Can also be apply by using the mounting bed kit for easy fixing on the wooden door without any milling cutter /cnc operation.
- The assembly bed kit can be paint in the required color and an integrity with the door can be achieved.
- Can be mounted on wood without processing.
- Mechanism body is made of stainless material.
- Can be used in wet places.
- For the gaps of wing, it's produced in 5 different types of sizes.
- There are 2 types of production; as right and left mechanism according to the inside view direction from which the area where the door is parked will be seen.
- It has aesthetic appearance and in well working system
- Available for use on interior doors.
- The required door handle and/or handle can be fixing on the door in one direction.

# MasterFold 42

40 KG KATLANIR SÜRME KAPI SİSTEMİ • FOLDABLE DOOR MECHANISM - FOLDING DOOR

Yeni Ürün  
New Product



## Bilgi / Information

- 2 Kapılı mekanizma içermektedir.
- Includes 2 door mechanism.



## 122-9042 1 Set İçeriği / 1 Set Includes



## Ray Profilleri / Rail Profiles

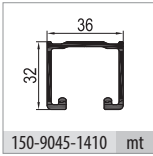

## Uygulama / Application



## Teknik Detay / Technical Detail

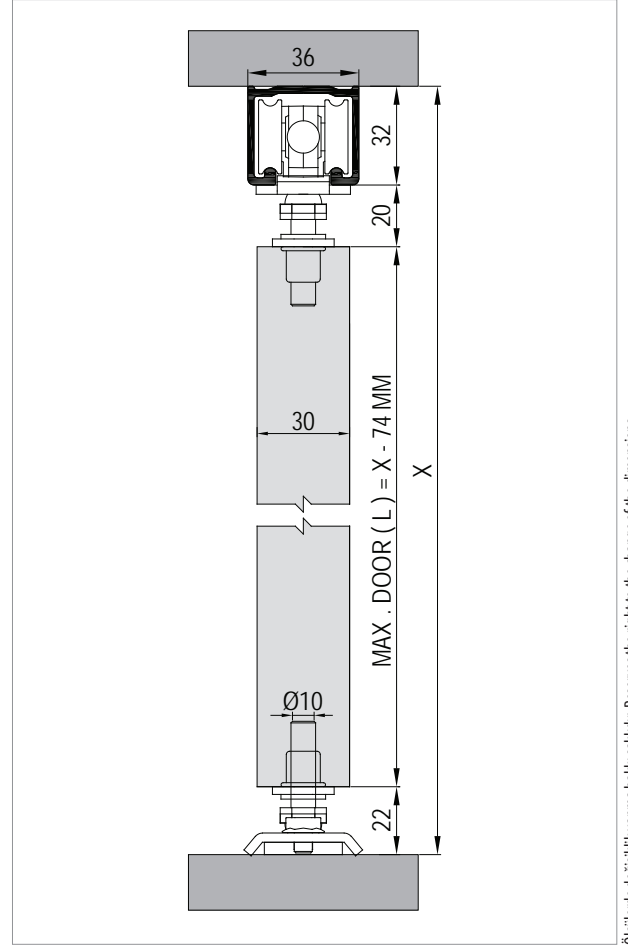

Ölçülerde değişiklik yapma hakkı saklıdır. Reserves the right to the change of the dimensions.

Kod / Code No	Açıklama / Description	Renk / Colour	Birim / Unit			Profil mt. / Profiles mt.	Bağ / Bnd.		
122-9042-1300	40 Kg Katlanır Sürme Kapı Sistemi / Foldable Door Mechanism - Folding Door	Gri / Grey	2 Kapı / 1 Set	12	360	-	-	-	
150-9045-1410	Alüminyum Üst Ray Profili / Aluminium Top Rail Profile	Eloksal / Mat Anodized	mt.	-	-	3,0	-	6,0	2 ad/pcs

# MasterFold 44

40 KG KATLANIR SÜRME KAPI SİSTEMİ • FOLDABLE DOOR MECHANISM - FOLDING DOOR

Yeni Ürün  
New Product



## Bilgi / Information

- 4 Kapılı mekanizma içermektedir.
- Includes 4 door mechanism.



## 122-9044 1 Set İçeriği / 1 Set Includes

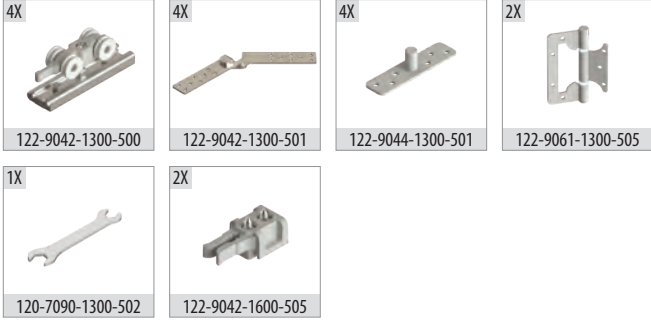

## Ray Profilleri / Rail Profiles

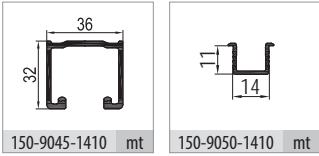

## Uygulama / Application



## Teknik Detay / Technical Detail

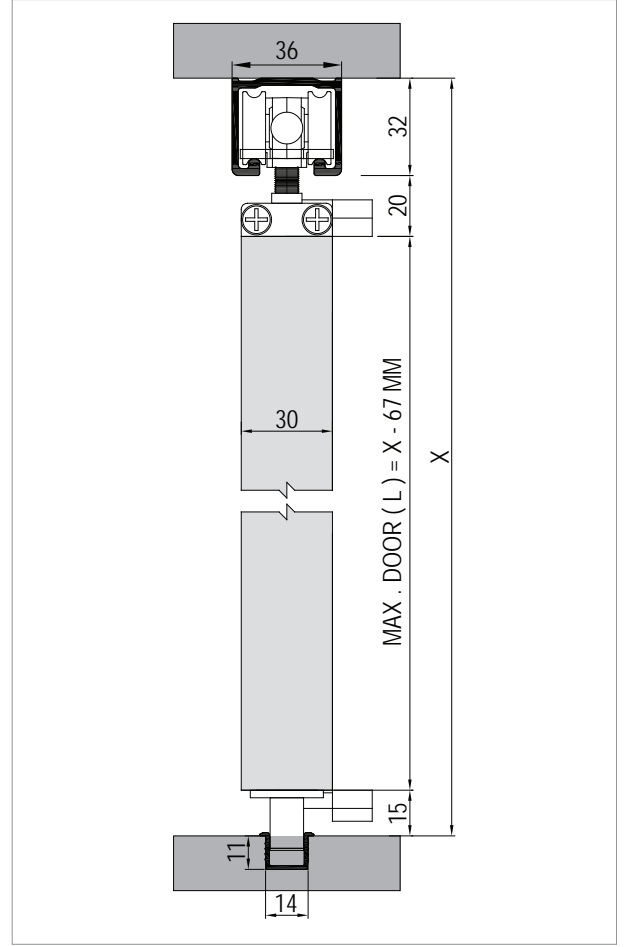

Ölçülerde değişiklik yapma hakkı saklıdır. Reserves the right to the change of the dimensions.

Kod / Code No	Açıklama / Description	Renk / Colour	Birim / Unit			Profil mt. / Profiles mt.	Bağ / Bnd.
122-9044-1300	40 Kg Katlanır Sürme Kapi Sistemi / Foldable Door Mechanism - Folding Door	Gri / Grey	4 Kapı / 1 Set	6	180	-	-
150-9045-1410	Alüminyum Üst Ray Profili / Aluminium Top Rail Profile	Eloksal / Mat Anodized	mt.	-	-	3,0	6,0
150-9050-1410	Alüminyum Alt Klavuz / Aluminium Bottom Slider	Eloksal / Mat Anodized	mt.	-	-	3,0	6,0

# MasterFold 60

60 KG KATLANIR SÜRME KAPI SİSTEMİ • FOLDABLE DOOR MECHANISM - FOLDING DOOR

Yeni Ürün  
New Product



## Bilgi / Information

- Minimum kapı panel kalınlığı 36 mm. olmalıdır.
- Door panel's thickness should be minimum 36 mm.



## 122-9060 1 Takım İçeriği / 1 Kit Includes

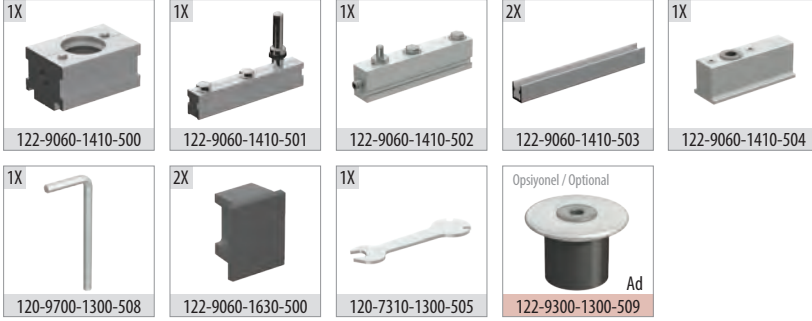

## 9061 1 Takım İçeriği / 1 Kit Includes

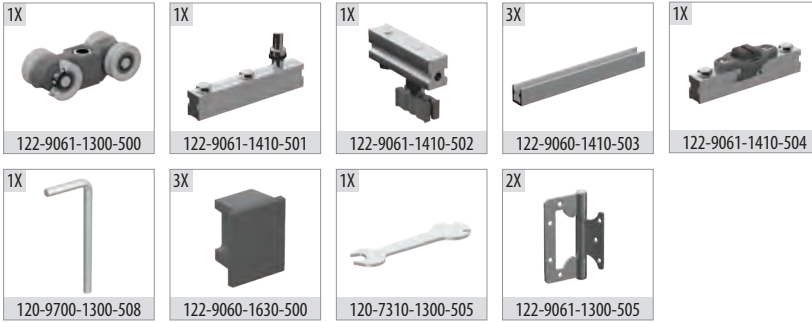

## Ray Profilleri / Rail Profiles

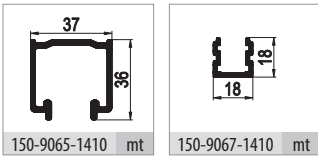

## Uygulama / Application



## Teknik Detay / Technical Detail

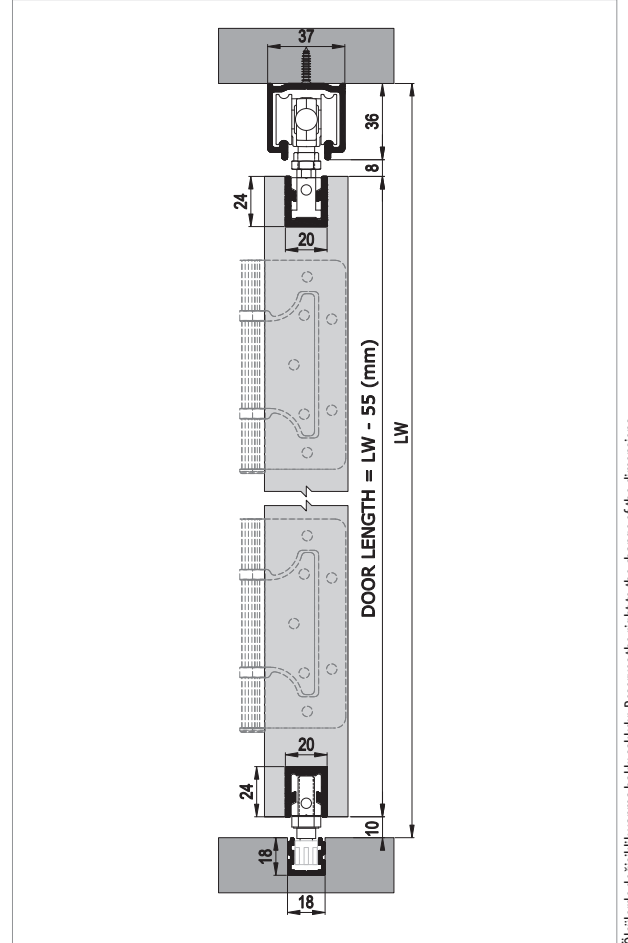

Ölçülerde değişiklik yapma hakkı saklıdır. Reserves the right to the change of the dimensions.

Kod / Code No	Açıklama / Description	Renk / Colour	Birim / Unit			Profil mt. / Profiles mt.	Bağ / Bnd.
122-9060-1410	Masterfold 60 - Sabit Kanat / Foldable Heavy Door System	Gri / Grey	1 Kapı / 1 Kit	16	512	-	-
122-9061-1410	Masterfold 60 - Sürme Katlanır Kapı Sistemi / Sliding Foldable Heavy Door System	Gri / Grey	1 Kapı / 1 Kit	16	512	-	-
122-9061-1300-505	Çelik Menteşe / Steel Hinge	Galvaniz / Galvanized	1 Adet / 1 Pcs	50	2.400	-	-
122-9300-1300-509	Zemin Pivot Burcu Paslanmaz / Ground Pivot Stainless	Galvaniz / Galvanized	1 Adet / 1 Pcs	100	9.600	-	-
150-9065-1410	Alüminyum Üst Ray Profili / Aluminium Top Rail Profile	Eloksal / Mat Anodized	mt.	-	-	-	6,0 6 ad/pcs
150-9067-1410	Alüminyum Alt Klavuz / Aluminium Bottom Slider	Eloksal / Mat Anodized	mt.	-	-	-	6,0 10 ad/pcs



# MidFold 60

60 KG KATLANIR SÜRME KAPI SİSTEMİ • FOLDABLE DOOR MECHANISM - FOLDING DOOR

Yeni Ürün  
New Product



## Bilgi / Information

- Minimum kapı panel kalınlığı 36 mm. olmalıdır.
- Door panel's thickness should be minimum 36 mm.



## 122-9060 1 Takım İçeriği / 1 Kit Includes

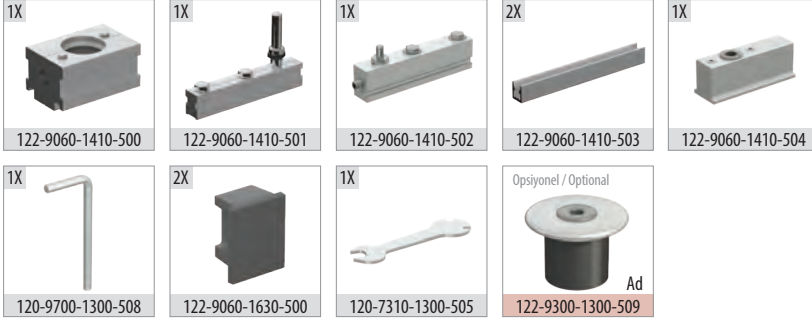

## 9062 1 Takım İçeriği / 1 Kit Includes

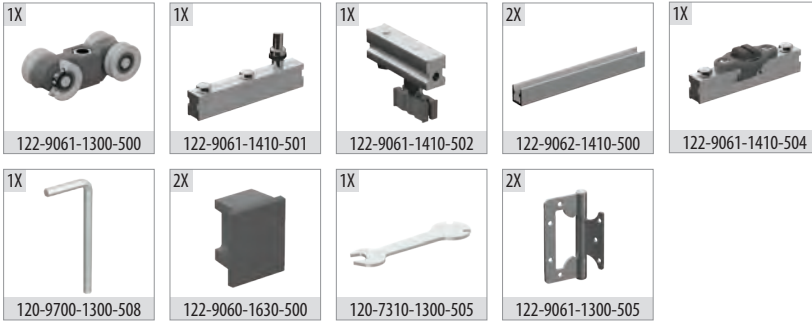

## Ray Profilleri / Rail Profiles

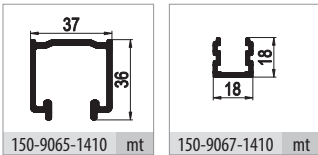

## Uygulama / Application



## Teknik Detay / Technical Detail

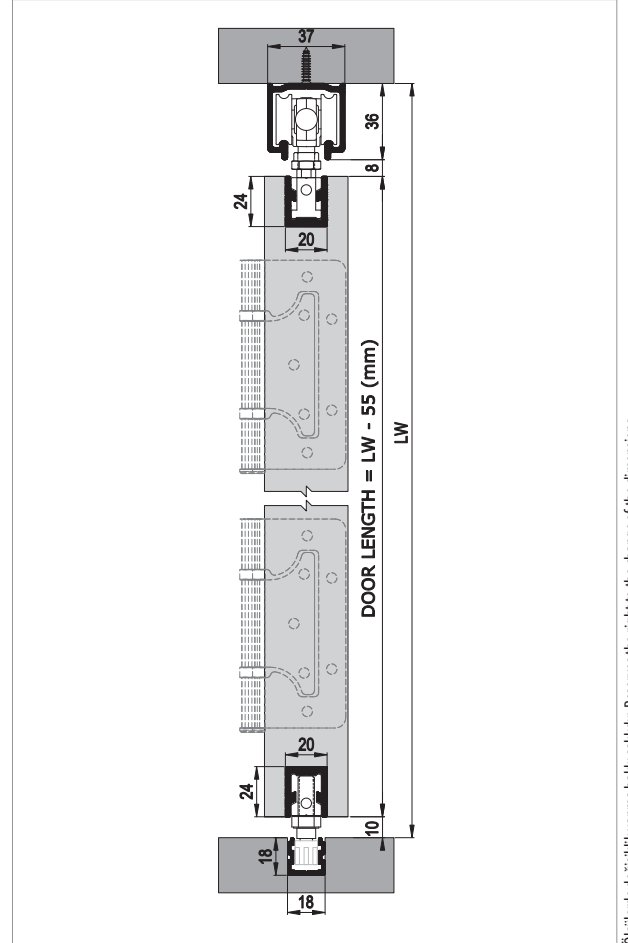

Ölçülerde değişiklik yapma hakkı saklıdır. Reserves the right to the change of the dimensions.

Kod / Code No	Açıklama / Description	Renk / Colour	Birim / Unit			Profil mt. / Profiles mt.	Bağ / Bnd.
122-9060-1410	Masterfold 60 - Sabit Kanat / Foldable Heavy Door System	Gri / Grey	1 Kapı / 1 Kit	16	512	-	-
122-9062-1410	Midfold 60 -Sürme Katlanır Kapı Sistemi / Sliding Foldable Heavy Door System	Gri / Grey	1 Kapı / 1 Kit	4	160	-	-
122-9061-1300-505	Çelik Menteşe / Steel Hinge	Galvaniz / Galvanized	1 Adet / 1 Pcs	50	2.400	-	-
122-9300-1300-509	Zemin Pivot Burcu Paslanmaz / Ground Pivot Stainless	Galvaniz / Galvanized	1 Adet / 1 Pcs	100	9.600	-	-
150-9065-1410	Alüminyum Üst Ray Profili / Aluminium Top Rail Profile	Eloksal / Mat Anodized	mt.	-	-	-	6,0 6 ad/pcs
150-9067-1410	Alüminyum Alt Klavuz / Aluminium Bottom Slider	Eloksal / Mat Anodized	mt.	-	-	-	6,0 10 ad/pcs

# MasterFold 160

160 KG KATLANIR SÜRME KAPI SİSTEMİ • FOLDABLE DOOR MECHANISM - FOLDING DOOR



## Bilgi / Information

- Minimum kapı panel kalınlığı 40 mm. olmalıdır.
- Door panel's thickness should be minimum 40 mm.



## 122-9300 1 Takım İçeriği / 1 Kit Includes

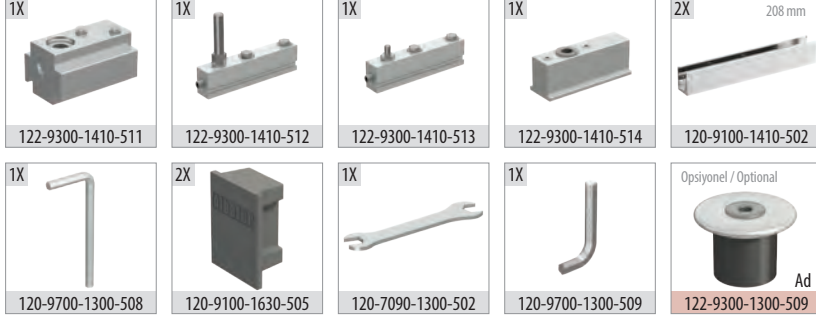

## 9400 1 Takım İçeriği / 1 Kit Includes

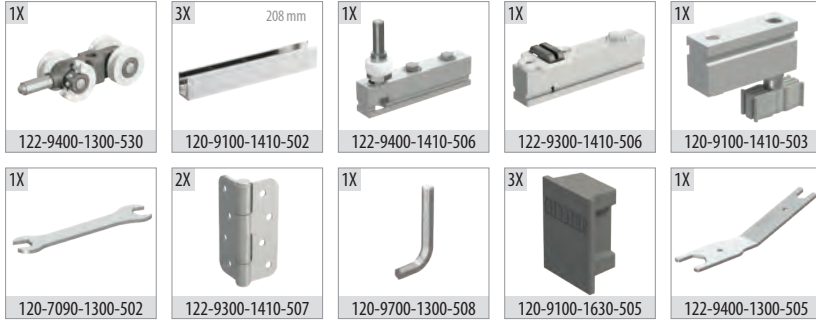

## Ray Profilleri / Rail Profiles

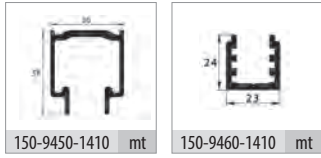

## Opsiyonel / Optional

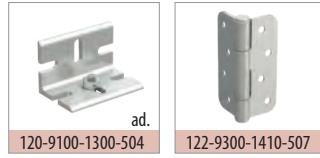

## Uygulama / Application



## Teknik Detay / Technical Detail

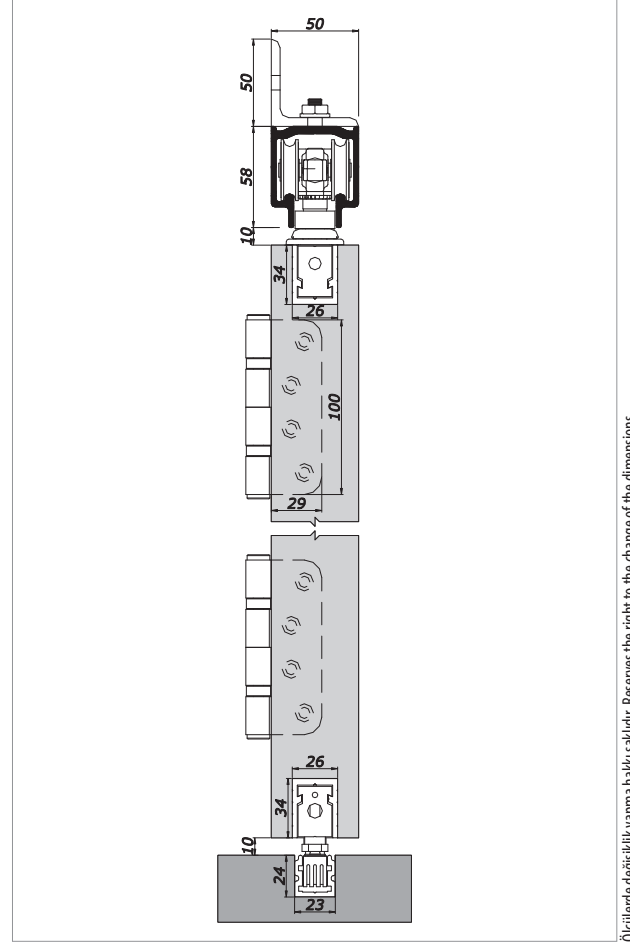

Ölçülerde değişiklik yapma hakkı saklıdır. Reserves the right to the change of the dimensions.

Kod / Code No	Açıklama / Description	Renk / Colour	Birim / Unit			Profil mt. / Profiles mt.			Bağ / Bnd.
122-9300-1410	MasterFold 160 Sabit Kanat / Foldable Heavy Door System	Gri / Grey	1 Kapı / 1 Kit	12	360	-	-	-	-
122-9400-1410	MasterFold 160 Katlanır Kapı Sistemi / Foldable Heavy Door System	Gri / Grey	1 Kapı / 1 Kit	12	360	-	-	-	-
120-9100-1300-504	Aski Aparatı / Hanger Parts	Galvaniz / Galvanized	1 Adet / 1 Pcs	50	2.400	-	-	-	-
122-9300-1300-509	Zemin Pivot Burcu Paslanmaz / Ground Pivot Stainless	Galvaniz / Galvanized	1 Adet / 1 Pcs	100	9.600	-	-	-	-
150-9450-1410	Alüminyum Üst Ray Profili / Aluminium Top Rail Profile	Eloksal / Mat Anodized	mt.	-	-	2,0	3,0	6,0	2 ad/pcs
150-9460-1410	Alüminyum Alt Ray Profili / Aluminium Bottom Rail Profile	Eloksal / Mat Anodized	mt.	-	-	2,0	3,0	6,0	8 ad/pcs



# 122-1050-1800

KATLANIR KAPI KİLİT MEKANİZMASI • FOLDING DOOR LOCK MECHANISM

Yeni Ürün  
New Product



1 Set İçeriği / 1 Set Includes



## Bilgi / Information

- Katlanır kapı sistemleri için üretilmiş kilit mekanizmasıdır.
- Lock mechanism for folding door systems.



## Teknik Detay / Technical Detail

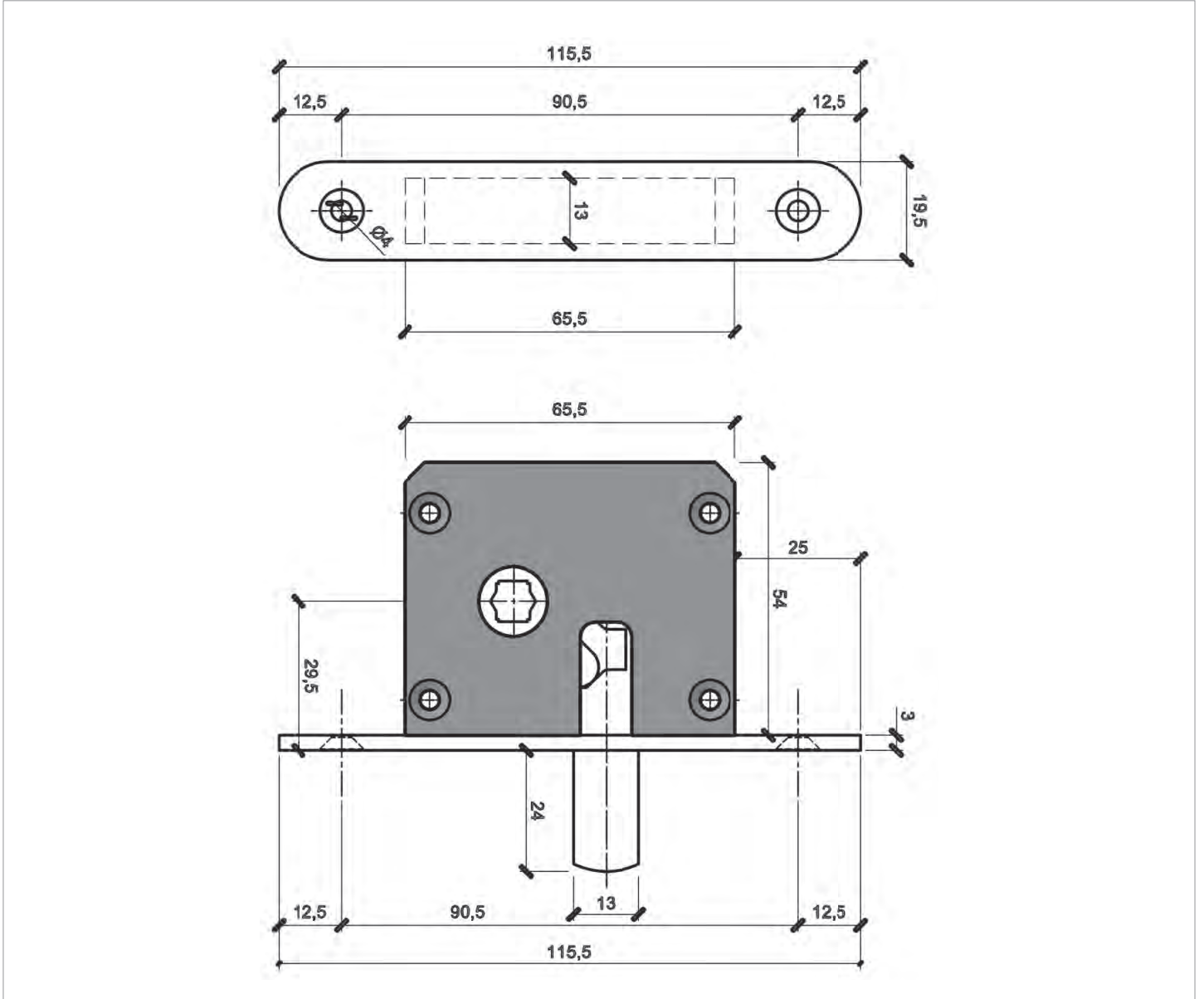

Kod / Code No	Açıklama / Description	Renk / Colour	Birim / Unit		
122-1050-1800	Katlanır Kapı Kilit Mekanizması • Folding Door Lock Mechanism	Galvaniz / Galvanized	1 Adet / 1 Pcs	-	-

# 122-1052-1820

YER SOKETİ • DUST PROOF STRIKE

Yeni Ürün  
New Product



1 Set İçeriği / 1 Set Includes



## Bilgi / Information

- Katlanır kapı sistemleri için üretilmiş kilit mekanizmasıdır.
- Lock mechanism for folding door systems.



## Teknik Detay / Technical Detail

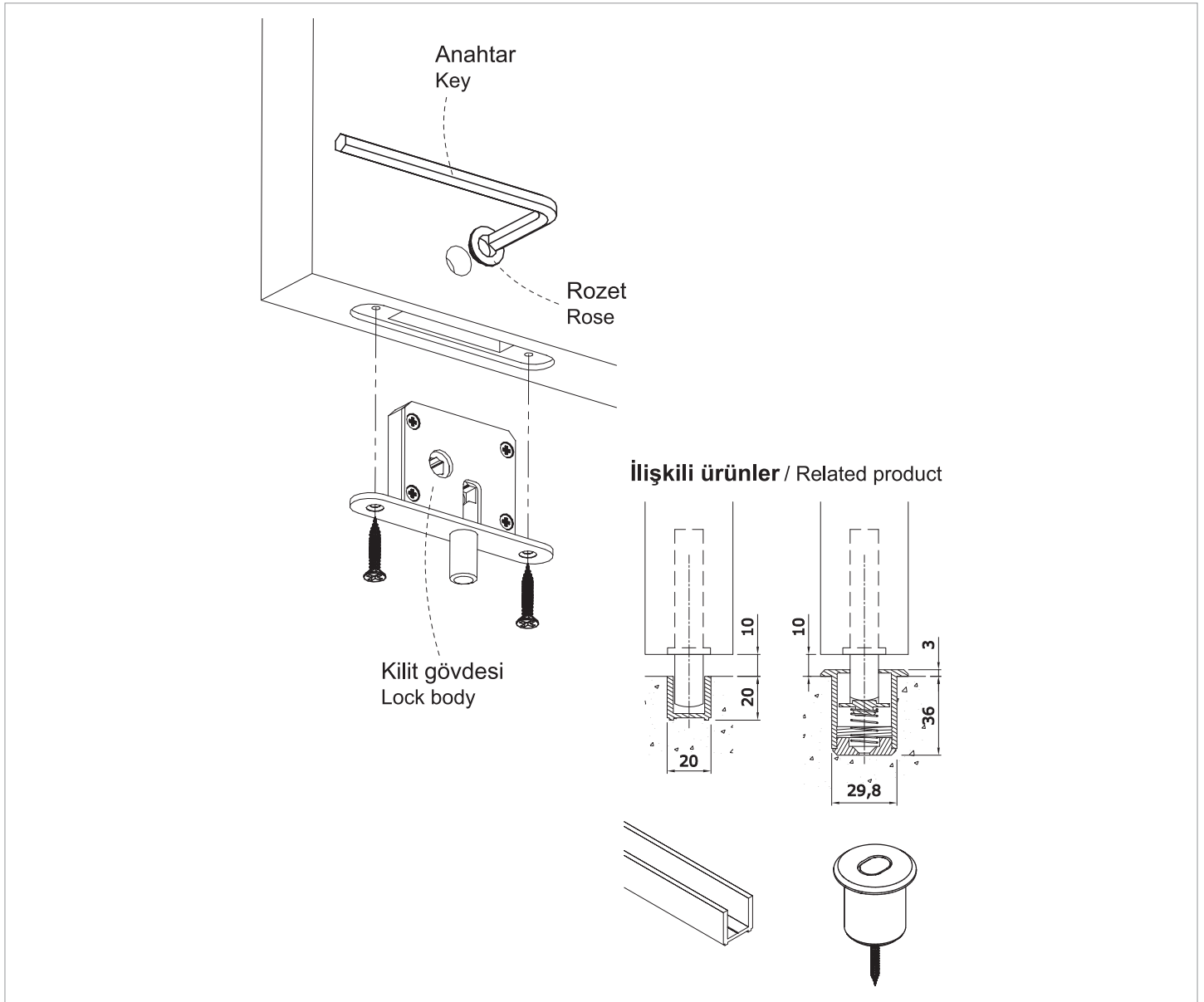

Kod / Code No	Açıklama / Description	Renk / Colour	Birim / Unit		
122-1052-1820	Yer Soketi • Dust Proof Strike	Galvaniz / Galvanized	1 Adet / 1 Pcs	-	-

# MasterFold 60

UYGULAMA ŞEMASI • APPLICATION SCHEME

# MidFold 60

UYGULAMA ŞEMASI • APPLICATION SCHEME

	9060 - 1 Tk 9061 - 1 Tk		9060 - 1 Tk 9062 - 1 Tk
	9060 - 1 Tk 9061 - 1 Tk		9060 - 2 Tk 9062 - 1 Tk
	9060 - 2 Tk 9061 - 1 Tk		9060 - 1 Tk 9062 - 1 Tk
	9060 - 2 Tk 9061 - 1 Tk		9060 - 2 Tk 9062 - 1 Tk
	9060 - 1 Tk 9061 - 2 Tk		9060 - 1 Tk 9062 - 2 Tk
	9060 - 1 Tk 9061 - 2 Tk		9060 - 2 Tk 9062 - 2 Tk
	9060 - 2 Tk 9061 - 2 Tk		9060 - 1 Tk 9062 - 3 Tk
	9060 - 1 Tk 9061 - 3 Tk		9060 - 2 Tk 9062 - 2 Tk
	9060 - 2 Tk 9061 - 2 Tk		9060 - 1 Tk 9062 - 3 Tk
	9060 - 1 Tk 9061 - 3 Tk		9060 - 2 Tk 9062 - 3 Tk
	9060 - 2 Tk 9061 - 3 Tk		9060 - 2 Tk 9062 - 2 Tk
	9060 - 2 Tk 9061 - 3 Tk		9060 - 2 Tk 9062 - 2 Tk
	9060 - 2 Tk 9061 - 2 Tk		9060 - 2 Tk 9062 - 4 Tk
	9060 - 2 Tk 9061 - 2 Tk		9060 - 2 Tk 9062 - 4 Tk
	9060 - 2 Tk 9061 - 4 Tk		9060 - 2 Tk 9062 - 6 Tk
	9060 - 2 Tk 9061 - 4 Tk		9060 - 2 Tk 9062 - 6 Tk
	9060 - 2 Tk 9061 - 6 Tk		
	9060 - 2 Tk 9061 - 6 Tk		

- Yüksekliği 2.100 mm olan kanatlarda, kapı başına 2 adet menteşe kullanılmalıdır.
- Yüksekliği 2.100 - 2.500 mm'ye kadar kanatlarda, kapı başına 3 adet menteşe kullanılmalıdır.
- Yüksekliği 2.500 - 2.700 mm'ye kadar kanatlarda, kapı başına 4 adet menteşe önerilir.
- Minimum kapı genişliği 380 mm olmalıdır.
- Maksimum kapı genişliği 900 mm olmalıdır.
- Minimum ahşap kapı panel kalınlığı 36 mm olmalıdır.
- Alüminyum Profil kanatlarda min. kapı panel kalınlığı 25 mm olmalıdır.
- Maksimum yükseklik 2.700 mm olmalıdır.
- Montaj esnasında uygulamaya göre ilave menteşe talep edilebilir.





















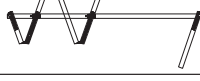





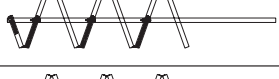



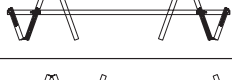

- 2.100 mm in height for doors, should be used 2 pcs hinge per door.
- Up to 2.100 - 2.500 mm in height for doors, 3 hinges should be used per door.
- Up to 2.500 - 2.700 mm in height for doors, 4 hinges should be used per door.
- Min. door width 380 mm
- Max. door width 900 mm
- Door panel's thickness should be min. 36 mm
- The minimum thickness should be 25mm on aluminum profile panel doors.
- Max. door height 2.700 mm
- An additional hinge steel hinge can be requested during the assembly.

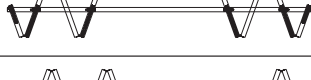
# MasterFold 160

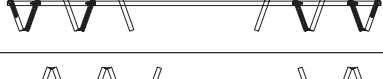
UYGULAMA ŞEMASI • APPLICATION SCHEME

# MidFold 160

UYGULAMA ŞEMASI • APPLICATION SCHEME

	9300 - 1 Tk. 9400 - 1 Tk.		9300 - 1 Tk. 9500 - 1 Tk.
	9300 - 1 Tk. 9400 - 1 Tk.		9300 - 2 Tk. 9500 - 1 Tk.
	9300 - 2 Tk. 9400 - 1 Tk.		9300 - 1 Tk. 9500 - 1 Tk.
	9300 - 2 Tk. 9400 - 1 Tk.		9300 - 2 Tk. 9500 - 1 Tk.
	9300 - 1 Tk. 9400 - 2 Tk.		9300 - 1 Tk. 9500 - 2 Tk.
	9300 - 1 Tk. 9400 - 2 Tk.		9300 - 2 Tk. 9500 - 2 Tk.
	9300 - 2 Tk. 9400 - 2 Tk.		9300 - 1 Tk. 9500 - 3 Tk.
	9300 - 1 Tk. 9400 - 3 Tk.		9300 - 2 Tk. 9500 - 2 Tk.
	9300 - 2 Tk. 9400 - 2 Tk.		9300 - 1 Tk. 9500 - 3 Tk.
	9300 - 1 Tk. 9400 - 3 Tk.		9300 - 2 Tk. 9500 - 3 Tk.
	9300 - 2 Tk. 9400 - 3 Tk.		9300 - 2 Tk. 9500 - 2 Tk.
	9300 - 2 Tk. 9400 - 3 Tk.		9300 - 2 Tk. 9500 - 2 Tk.
	9300 - 2 Tk. 9400 - 2 Tk.		9300 - 2 Tk. 9500 - 4 Tk.
	9300 - 2 Tk. 9400 - 2 Tk.		9300 - 2 Tk. 9500 - 4 Tk.
	9300 - 2 Tk. 9400 - 4 Tk.		9300 - 2 Tk. 9500 - 6 Tk.
	9300 - 2 Tk. 9400 - 4 Tk.		9300 - 2 Tk. 9500 - 6 Tk.
	9300 - 2 Tk. 9400 - 6 Tk.		
	9300 - 2 Tk. 9400 - 6 Tk.		

\* Yüksekliği 2500 mm olan kanatlarda, kapı başına 2 adet 122-9300-1410-507 kullanılmalıdır.

\* Yüksekliği 2500 mm'den büyük kanatlarda, kapı başına 3 adet 122-9300-1410-507 kullanılmalıdır.

\* Minimum kapı genişliği 550 mm olmalıdır.

\* Maksimum kapı genişliği 950 mm olmalıdır.

\* Minimum kapı panel kalınlığı 40 mm olmalıdır.

\* Maksimum yükseklik 2.700 mm olmalıdır.

\* Montaj esnasında uygulamaya göre ilave 122-9300-1410-507 menteşe talep edilebilir.

\* 2500 mm in height for doors, should be used 2 pcs 122-9300-1410-507 per door

\* More than height 2500 mm for doors, should be used 3 pcs 122-9300-1410-507 per door

\* Min. door width 550 mm

\* Max. door width 950 mm

\* Door panel's thickness should be min. 40 mm

\* Max. door height 2.700 mm

\* An additional 122-9300-1410-507 steel hinge can be requested during the assembly.





